

- NOTE:
1. MATERIAL:
 - 1.1 USB-C PLUG CONN (P/N:10133475-10000LF)
 - 1.2 PCB (CUSTOMIZED)
 2. LEAD FREE PRODUCT MEETS EUROPEAN UNION DIRECTIVES AND OTHER COUNTRY REGULATIONS AS DISCRIBLED IN GS-22-008
 3. PRODUCT IS HALOGEN FREE PRODUCTS.
 4. DIMENSIONING SHALL BE INTERPRETED PER ANSI Y14.5-2009;
 5. THIS DESIGN COMPLY WITH UNIVERSAL SERIAL BUS TYPE-C SPECIFICATION

PART MUNBER CODE: 10144277 - X 0 0 0 X LF

PCB OPTION(SEE CORRESPONDING SHEET)

0. DEFAULT
1. SPECILAL

PCB AND ELECTRON COMPONENT OPTION

- 2: WITH PCB STYLE 2 (REF SHEET 2)
- 3: WITH PCB STYLE 3 (REF SHEET 3)
- 4: WITH PCB STYLE 4 (REF SHEET 4)
- 5: WITH PCB STYLE 5 + FEMALE HEADER 10 POS CONN (REF SHEET 5)
- 6: WITH PCB STYLE 6 + HEADER 10POS CONN+ RESISTORS (REF SHEET 6)
- 7: WITH PCB STYLE 7 (REF SHEET 7)
- 8: WITH PCB STYLE 8 (REF SHEET 8)

Amphenol
FCi

© 2020 Amphenol Corporation

spec ref -		dr	Li-Qing Lei	2017/06/13	projection 	mm ←→	size	A3	scale	1.000
tolerance std ISO 406 ISO 1101		TOLERANCES UNLESS OTHERWISE SPECIFIED		eng			Li-Qing Lei	2026/05/07	ecn no	
		chr	-	-	product family		rel lev		PDF	Released
surface		linear	0.X	±0.35	Amphenol FCi	USB Type-C CABLE PLUG KITS	dwg no	10144277	rev	G
			0.XX	±0.25						
ISO 1302		0.XXX	±0.15							
		angular	0°	±2°	cat. no.		Product - Customer Drw		sheet 1 of 8	

PART MUMBER
10144277-20000LF

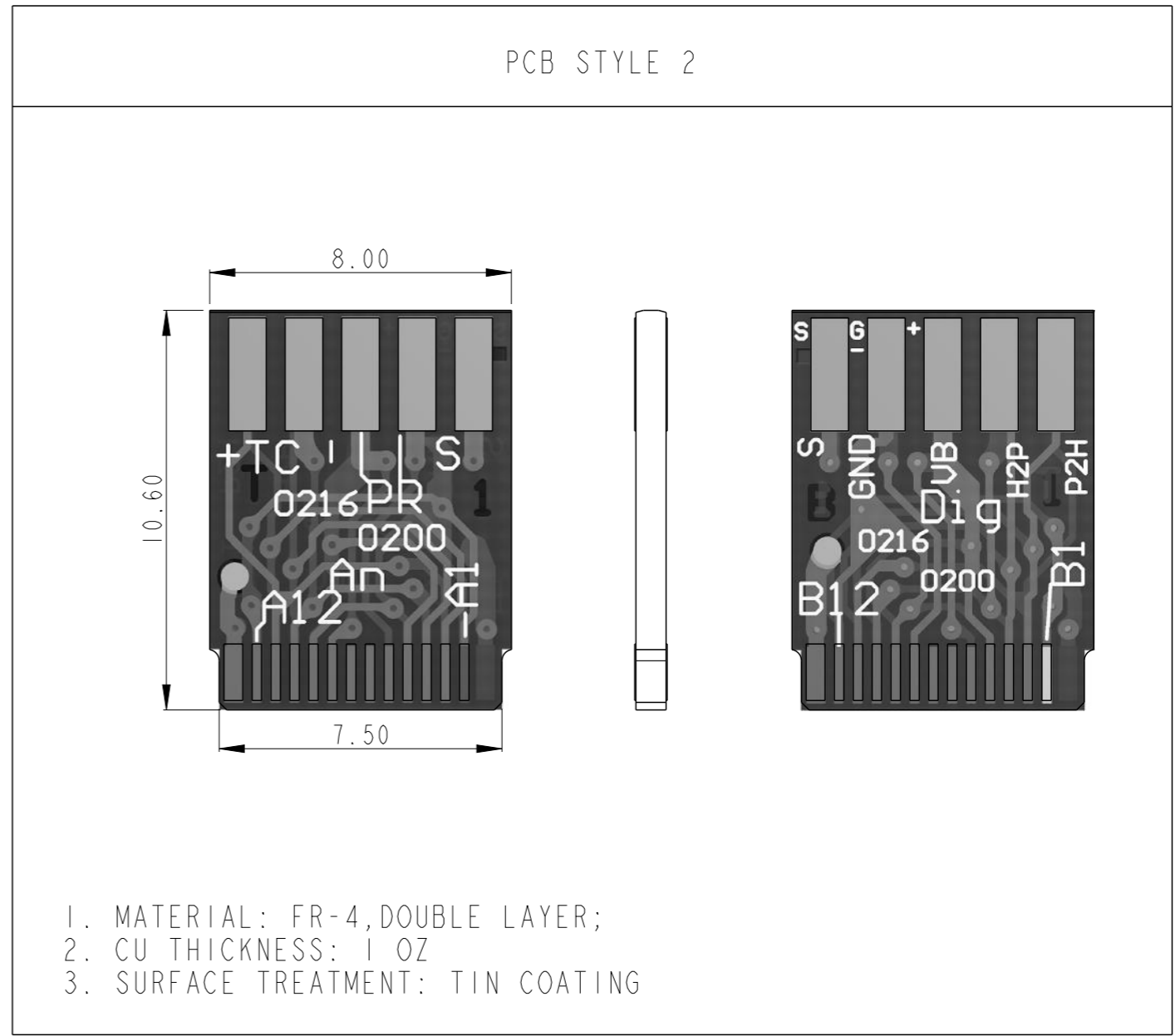
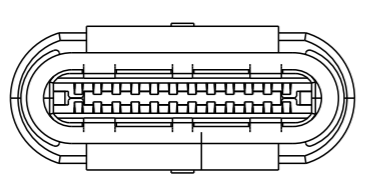
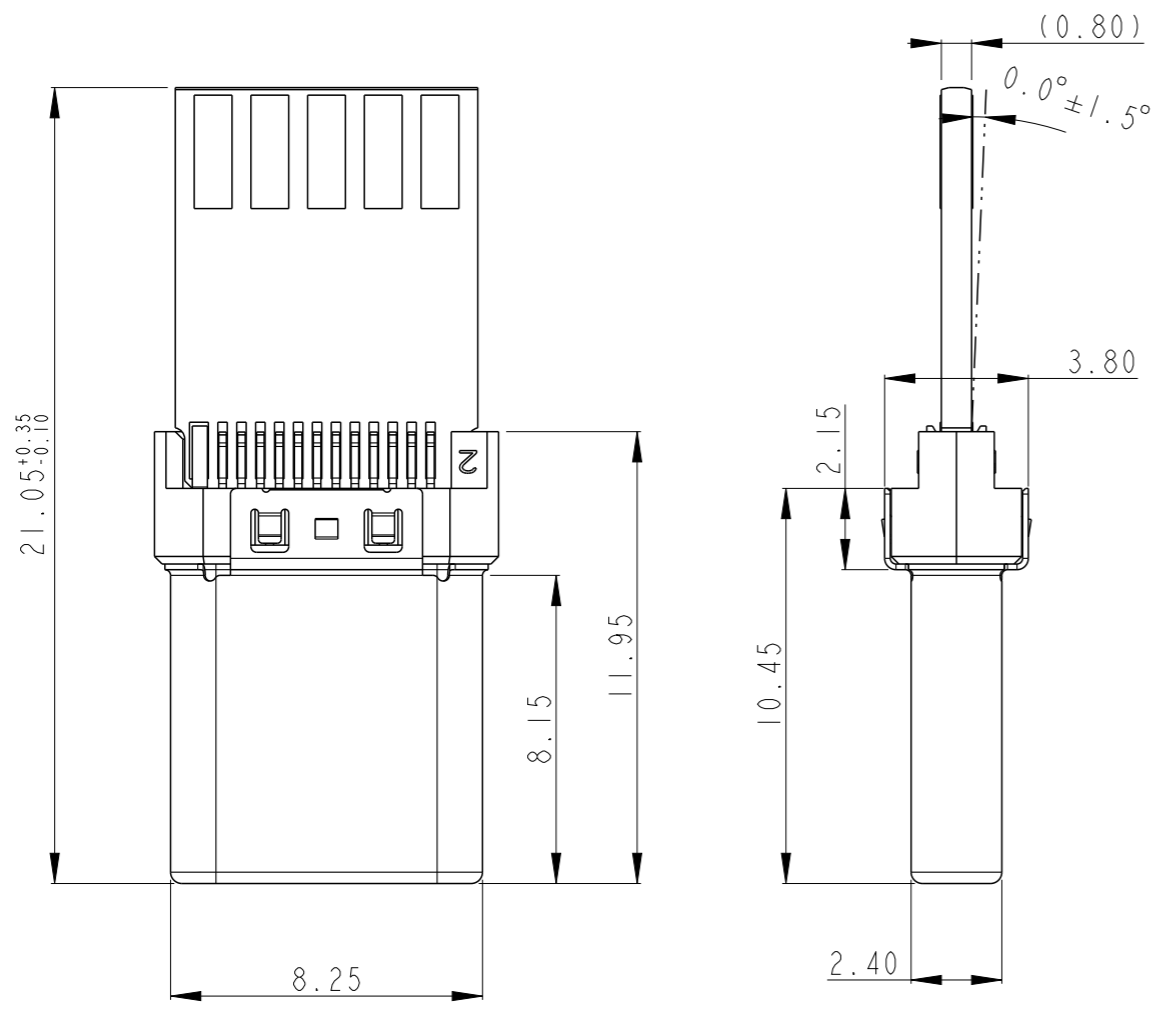

Amphenol
FCi

© 2020 Amphenol Corporation

spec ref -		dr Li-Qing Lei	2017/06/13	projection 	mm ←→	size A3	scale 5.000
tolerance std ISO 406 ISO 1101		eng Li-Qing Lei	2026/05/07			ecn no ELX-N-288051-1	
TOLERANCES UNLESS OTHERWISE SPECIFIED		chr -	-			rel lev PDF Released	
surface	linear	0.X	±0.35	Amphenol FCi	USB Type-C CABLE PLUG KITS	dwg no 10144277	rev G
		0.XX	±0.25				
		0.XXX	±0.15				
	angular	0°	±2°	cat. no.	Product - Customer Drw	sheet 2 of 8	

PART MUNBER	COLOR OF THE DOT
10144277-30000LF	BLACK
10144277-30001LF	WHITE

48.45^{+0.35}_{-0.10}

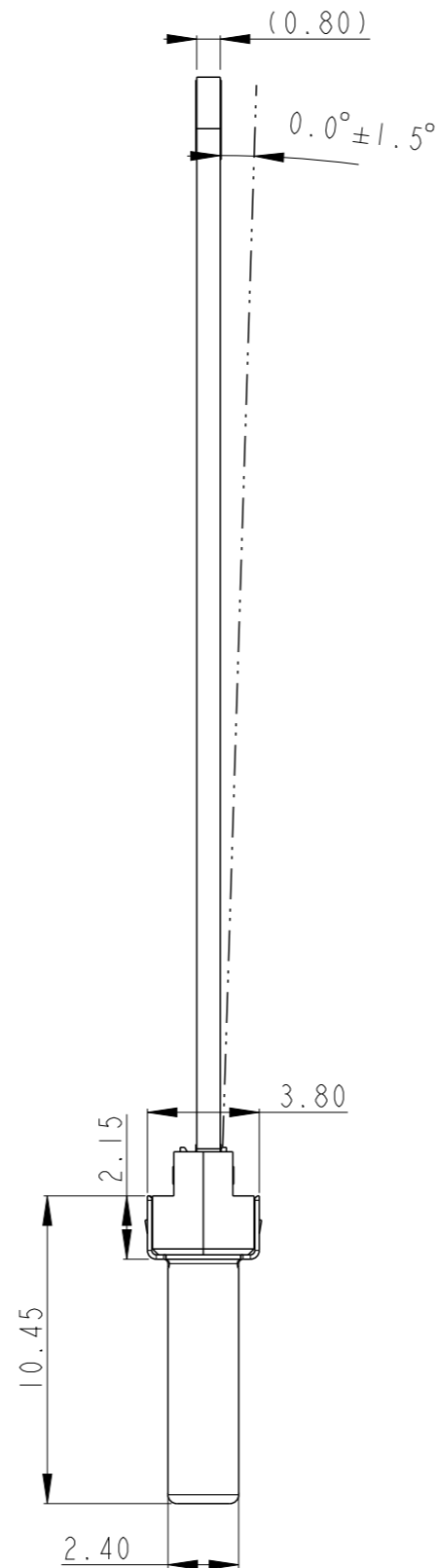
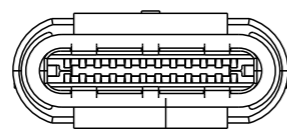
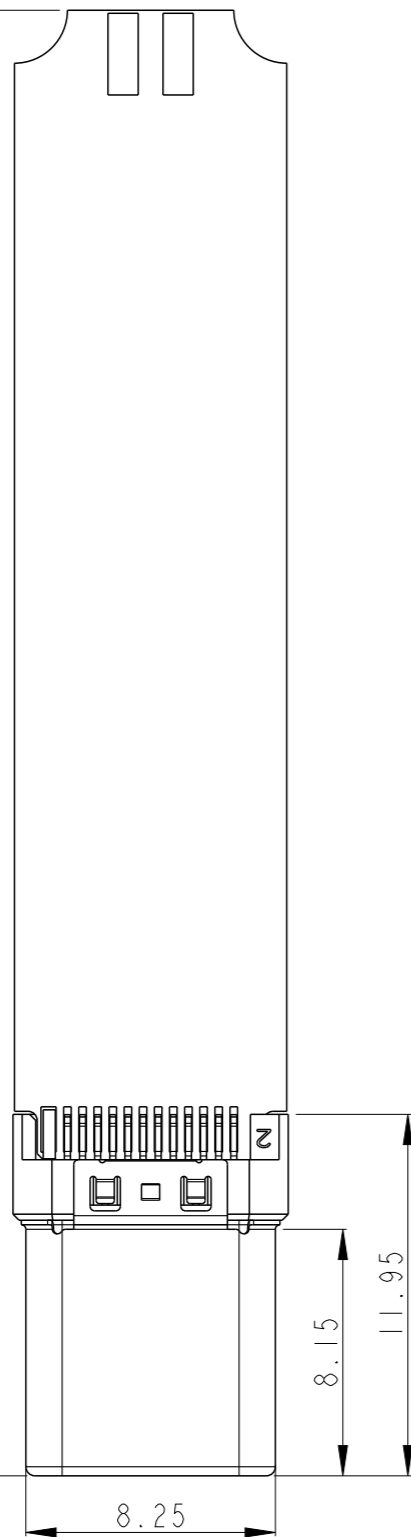

PCB STYLE 3

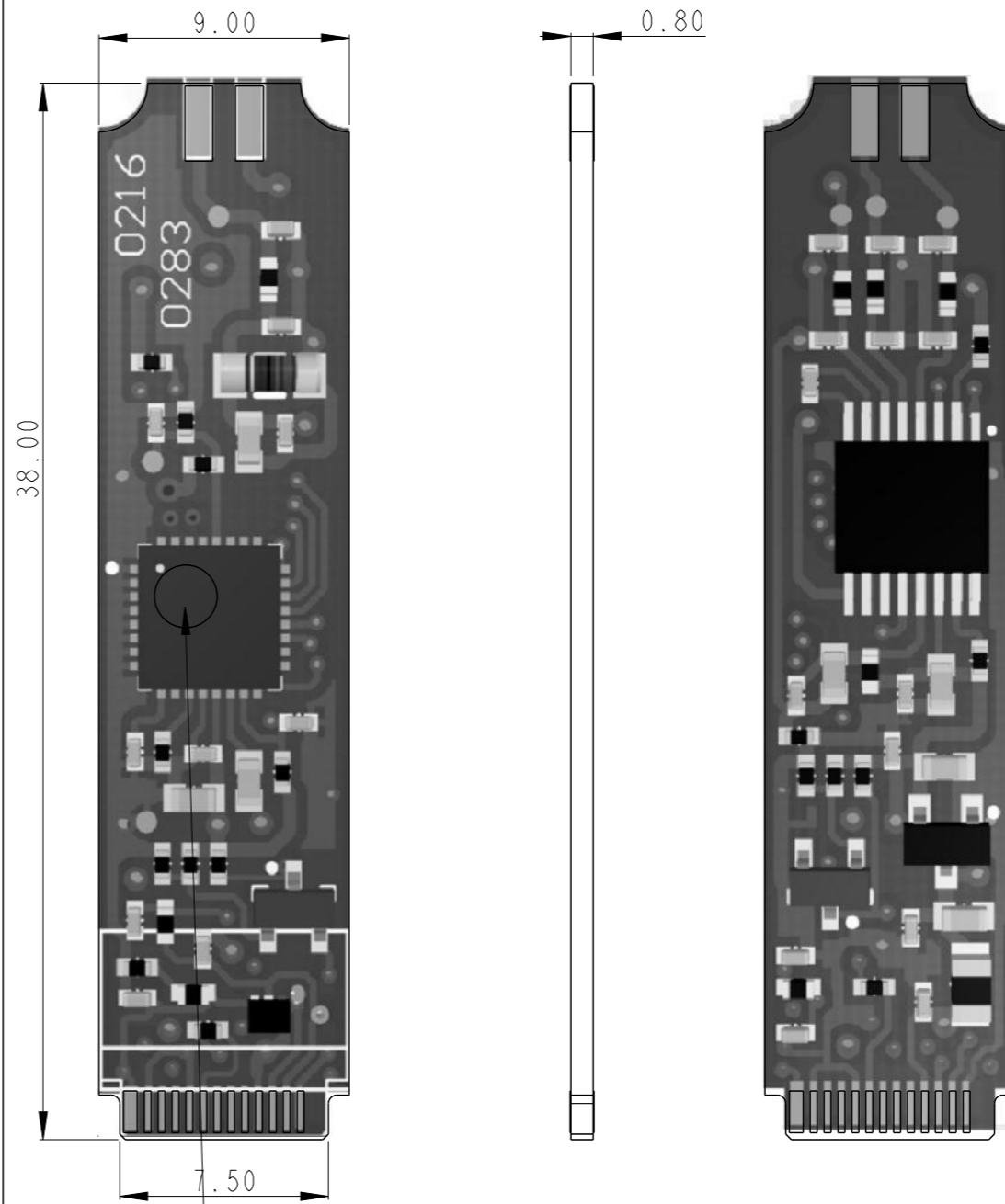

THERE'S A COLORED DOT HERE,
 1. IF DOT IS BLACK, THE P/N OF THE FINISHED GOODS IS 10144277-30000LF
 2. IF DOT IS WHITE, THE P/N OF THE FINISHED GOODS IS 10144277-30001LF

PCBA IS CUSTOMIZED

spec ref	-	dr	Li-Qing Lei	2017/06/13	projection	mm	size	A3	scale	1.000
tolerance std	ISO 406 ISO 1101	eng	Li-Qing Lei	2026/05/07			ecn no	ELX-N-288051-1	rel lev PDF Released	
surface	linear	chr	-	-			product family	rel lev PDF Released	rev	
		appr	Tim Yao	2026/05/07			dwg no	10144277	sheet 3 of 8	
					USB Type-C CABLE PLUG KITS				Product - Customer Drw	
					cat. no.				STATUS: Released Printed: May 07, 2026	

PART NUMBER
10144277-40000LF

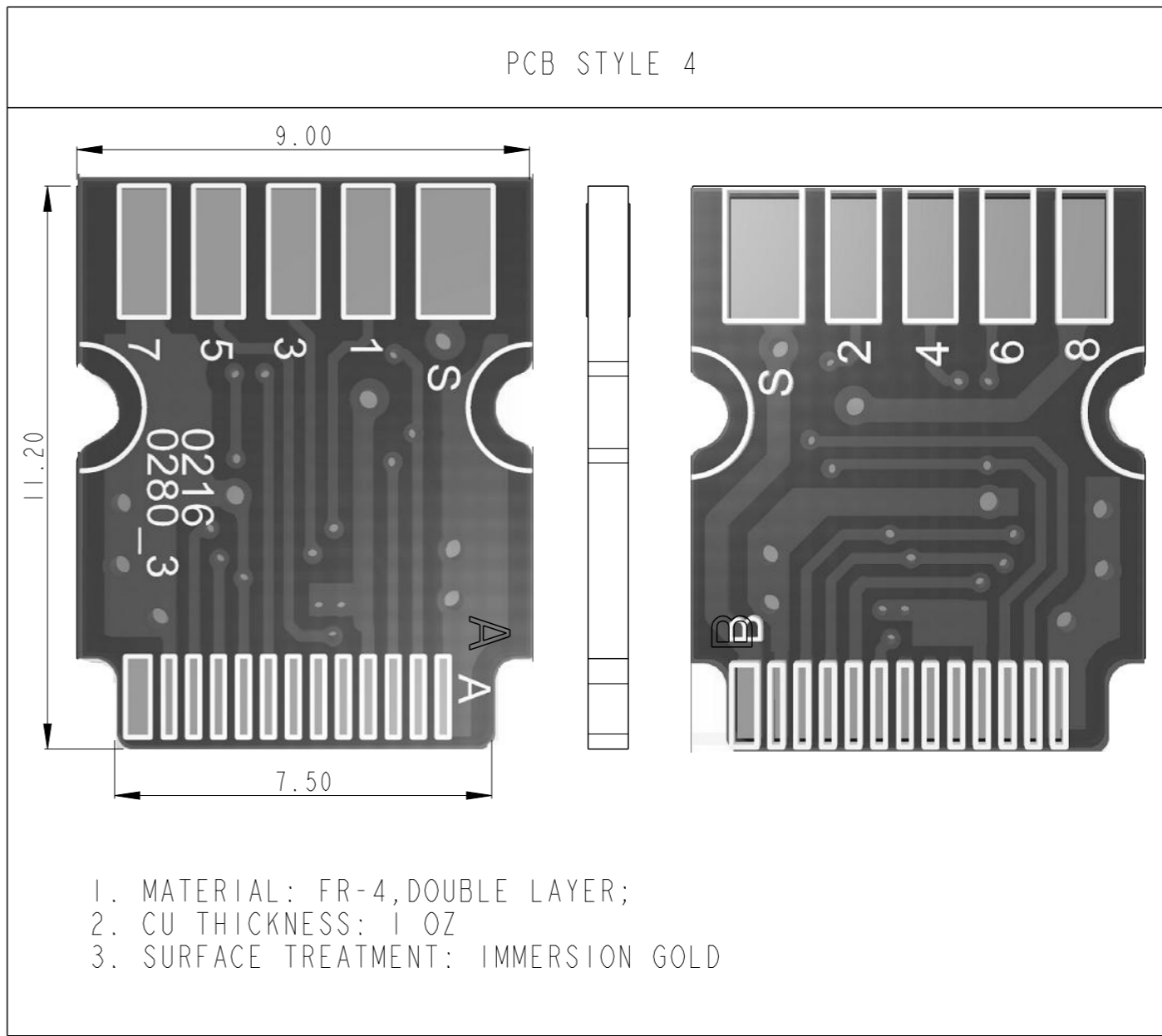
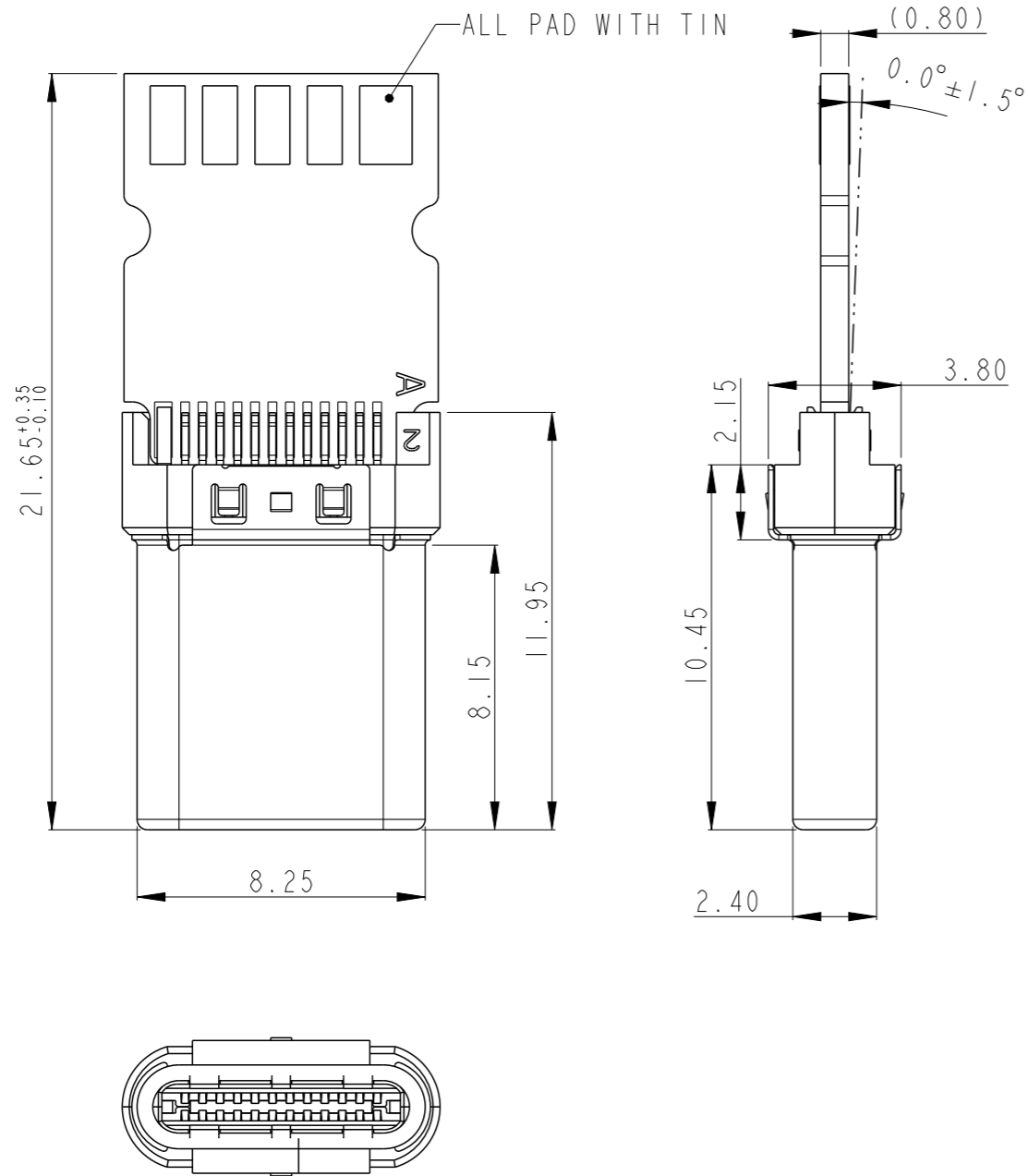

1. MATERIAL: FR-4, DOUBLE LAYER;
2. CU THICKNESS: 1 OZ
3. SURFACE TREATMENT: IMMERSION GOLD

Amphenol
FCi

© 2020 Amphenol Corporation

spec ref -		dr Li-Qing Lei	2017/06/13	projection 	mm ←→	size A3	scale 4.000
tolerance std ISO 406 ISO 1101		eng Li-Qing Lei	2026/05/07			ecn no ELX-N-288051-1	rel lev PDF Released
surface	linear	0.X	±0.35	Amphenol FCi title USB Type-C CABLE PLUG KITS		dwg no 10144277	rev G
		0.XX	±0.25				
0.XXX	±0.15						
ISO 1302	angular	0°	±2°	cat. no.	Product - Customer Drw	sheet 4 of 8	

Creo File:ELX-WC-A3C.REV F.2020-12-21

PART MUMBER
10144277-50000LF

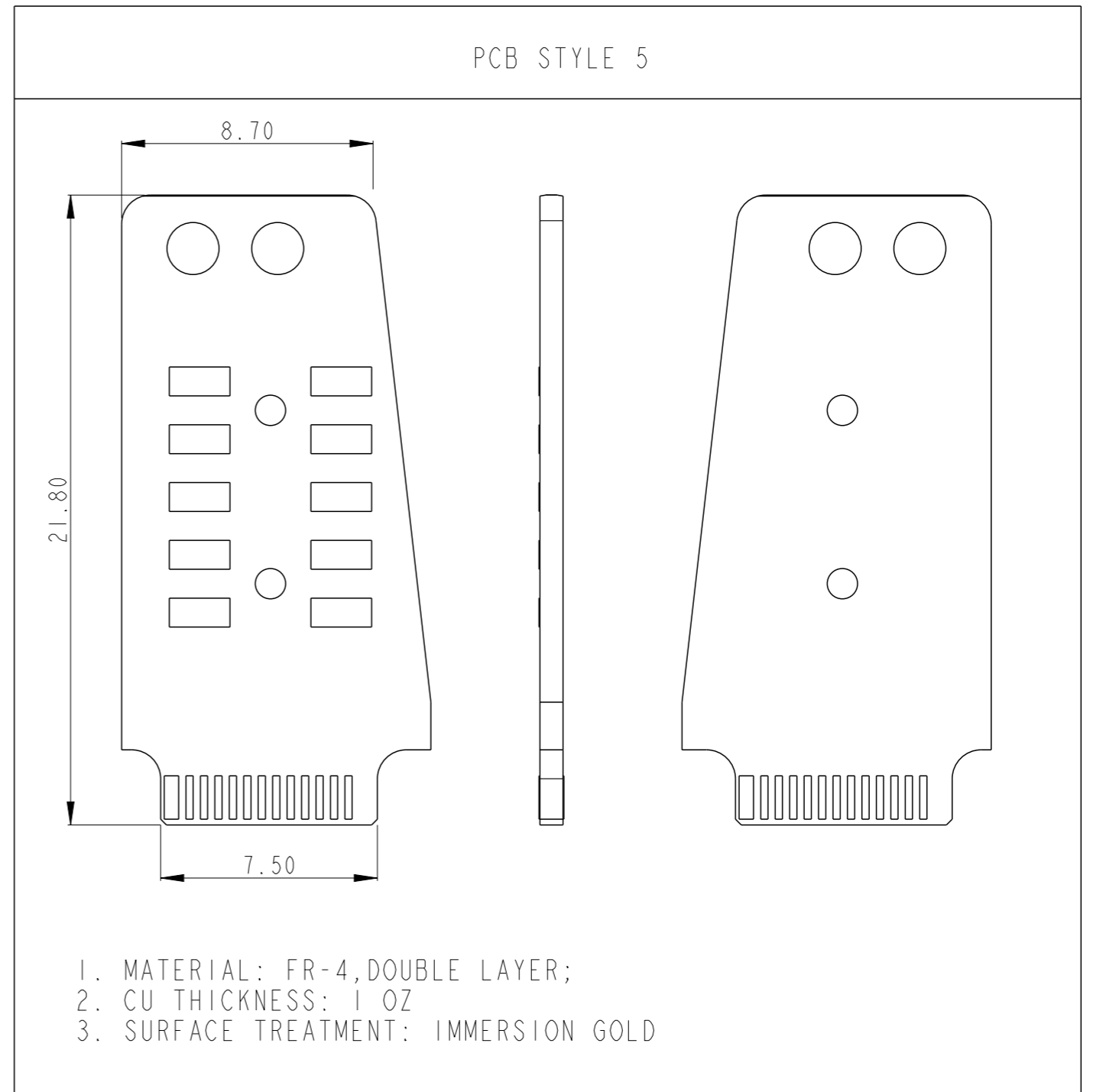
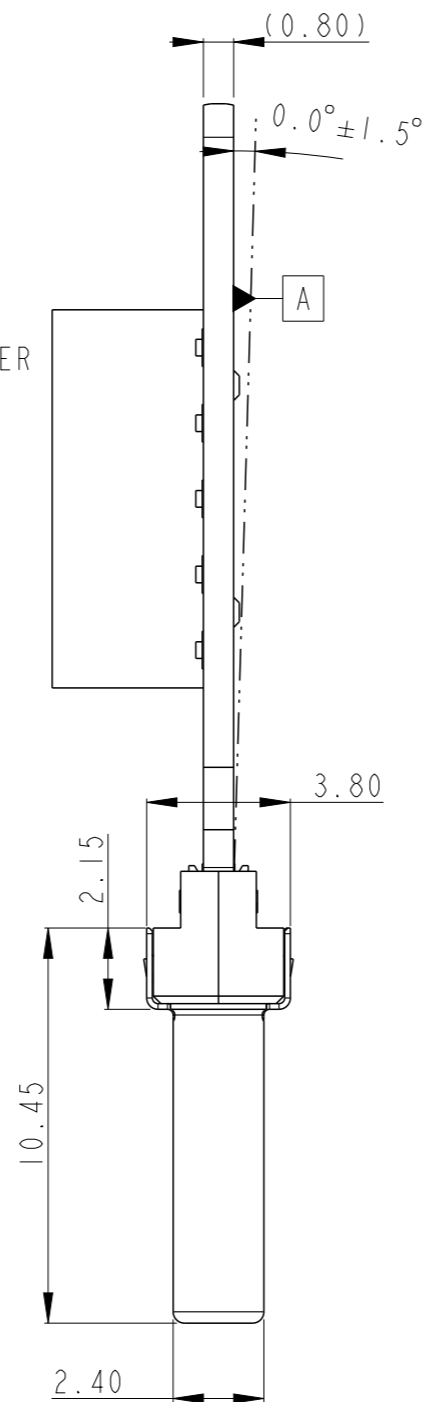
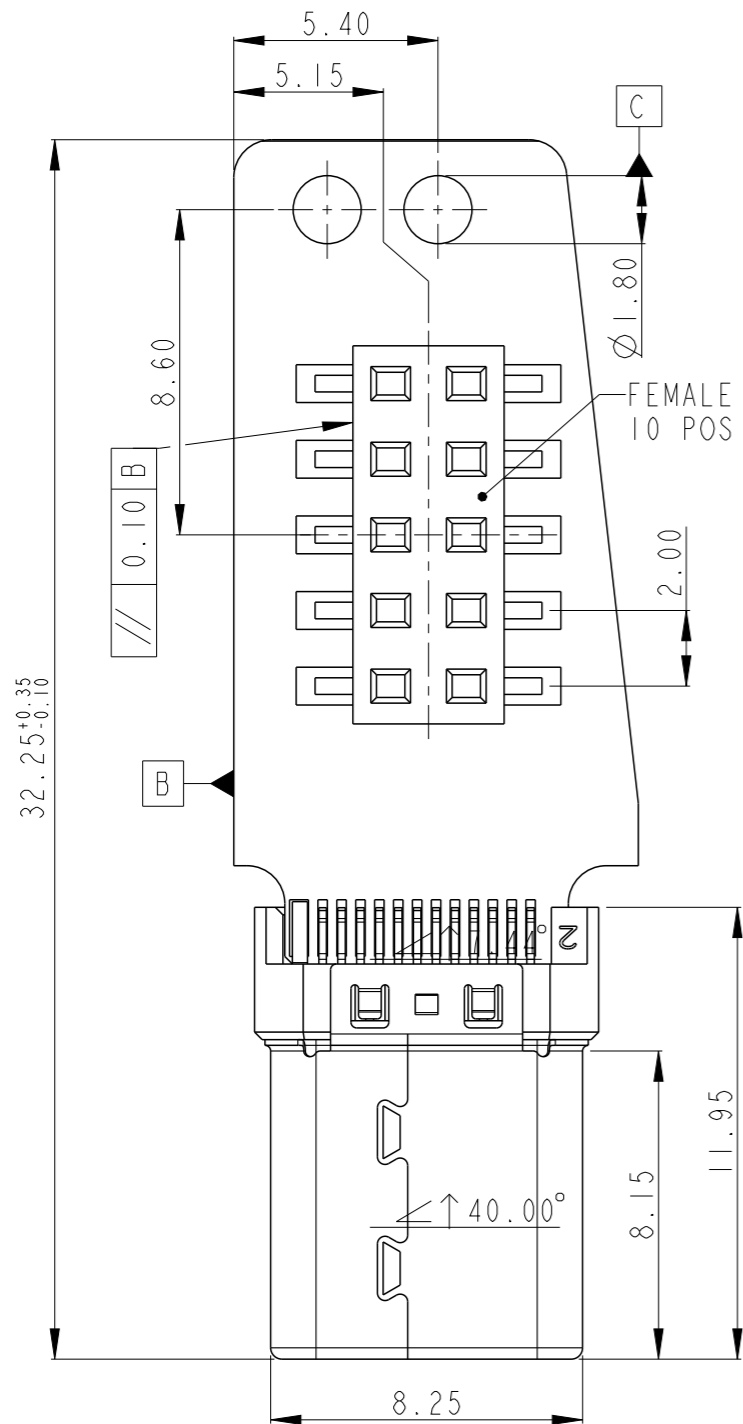

spec ref	-	dr	Li-Qing Lei	2017/06/13	projection	mm	size	A3	scale	1.000	
tolerance std	ISO 406 ISO 1101	eng	Li-Qing Lei	2026/05/07			ecn no	ELX-N-288051-1	rel lev Released		
TOLERANCES UNLESS OTHERWISE SPECIFIED		chr	-	-			product family	rel lev Released			
surface	linear	0.X	±0.35	Amphenol FCI	USB Type-C		dwg no 10144277	rev		G	
		0.XX	±0.25		CABLE PLUG KITS						
		0.XXX	±0.15								
ISO 1302	angular	0°	±2°	cat. no.	Product - Customer Drw		sheet 5 of 8				

PART MUMBER
10144277-60000LF

A

B

C

D

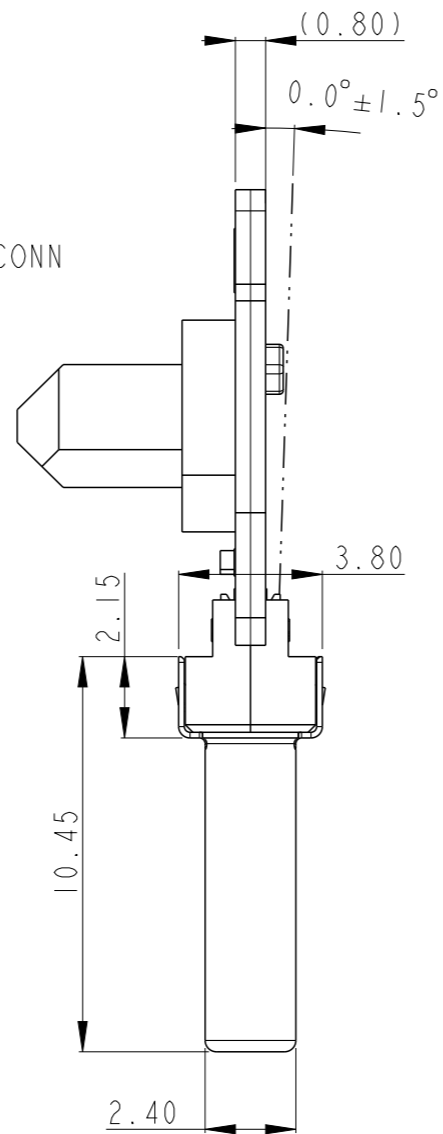
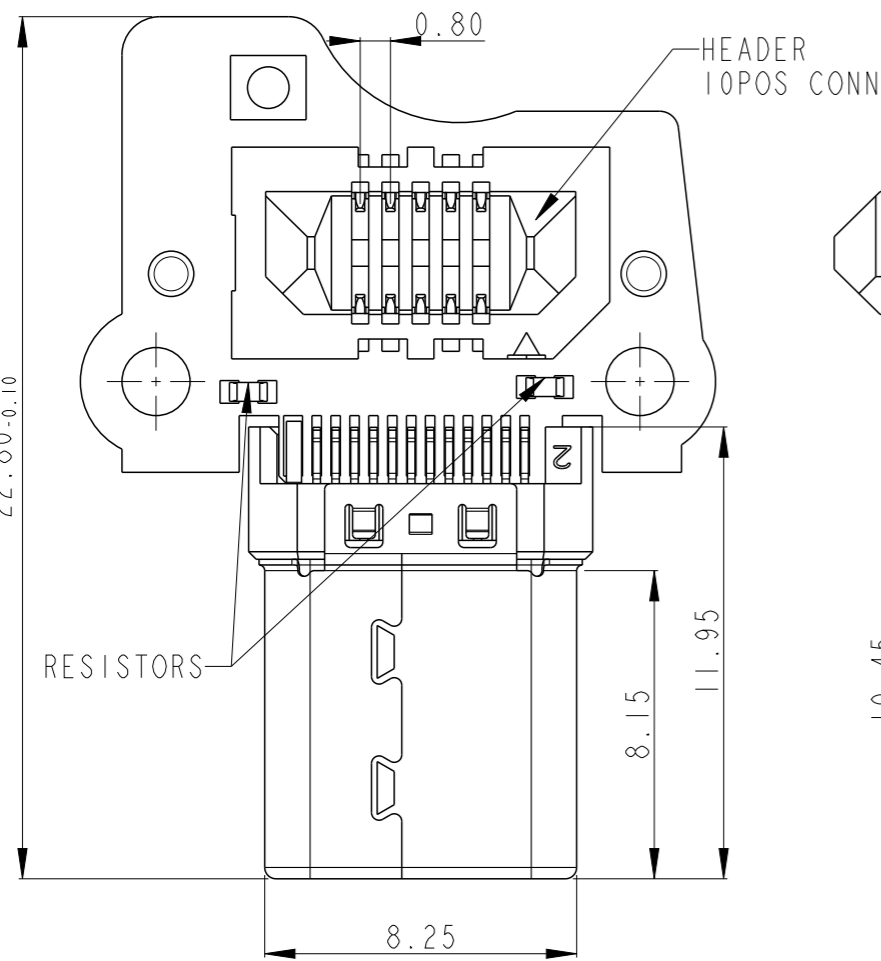

PCB STYLE 6

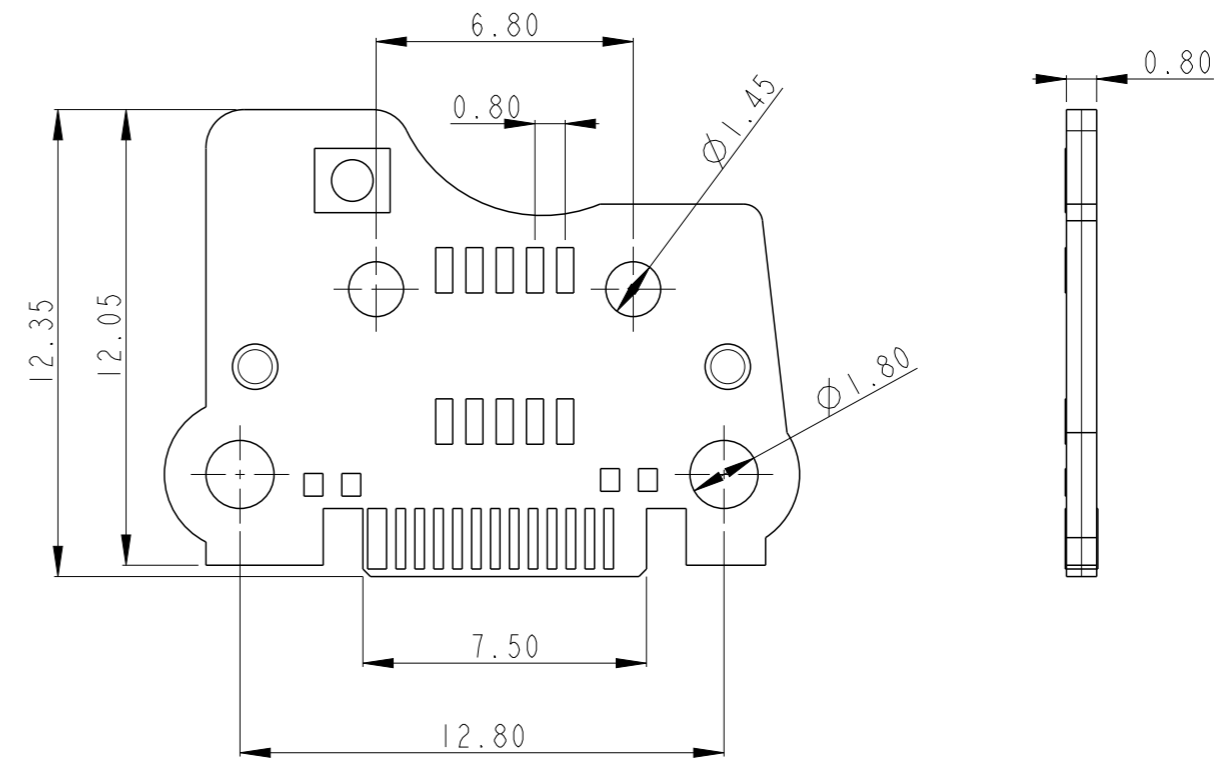

1. MATERIAL: FR-4, DOUBLE LAYER;
2. CU THICKNESS: 1 OZ
3. SURFACE TREATMENT: IMMERSION GOLD

A

B

C

D

spec ref -		dr	Li-Qing Lei	2017/06/13	projection	mm	size	A3	scale	1.000
tolerance std ISO 406 ISO 1101		eng	Li-Qing Lei	2026/05/07			ecn no	ELX-N-288051-1		
TOLERANCES UNLESS OTHERWISE SPECIFIED		chr	-	-		product family	rel lev	PDF Released		
		appr	Tim Yao	2026/05/07	USB Type-C CABLE PLUG KITS		dwg no	10144277	rev	G
surface	linear	0.X	±0.35	Amphenol FCi	cat. no.	Product - Customer Drw		sheet 6 of 8		
		0.XX	±0.25							
		0.XXX	±0.15							
	angular	0°	±2°							

PART MUMBER	COLOR OF THE DOT
10144277-70000LF	BLACK
10144277-70001LF	WHITE

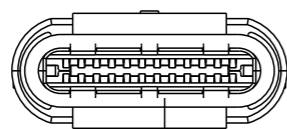
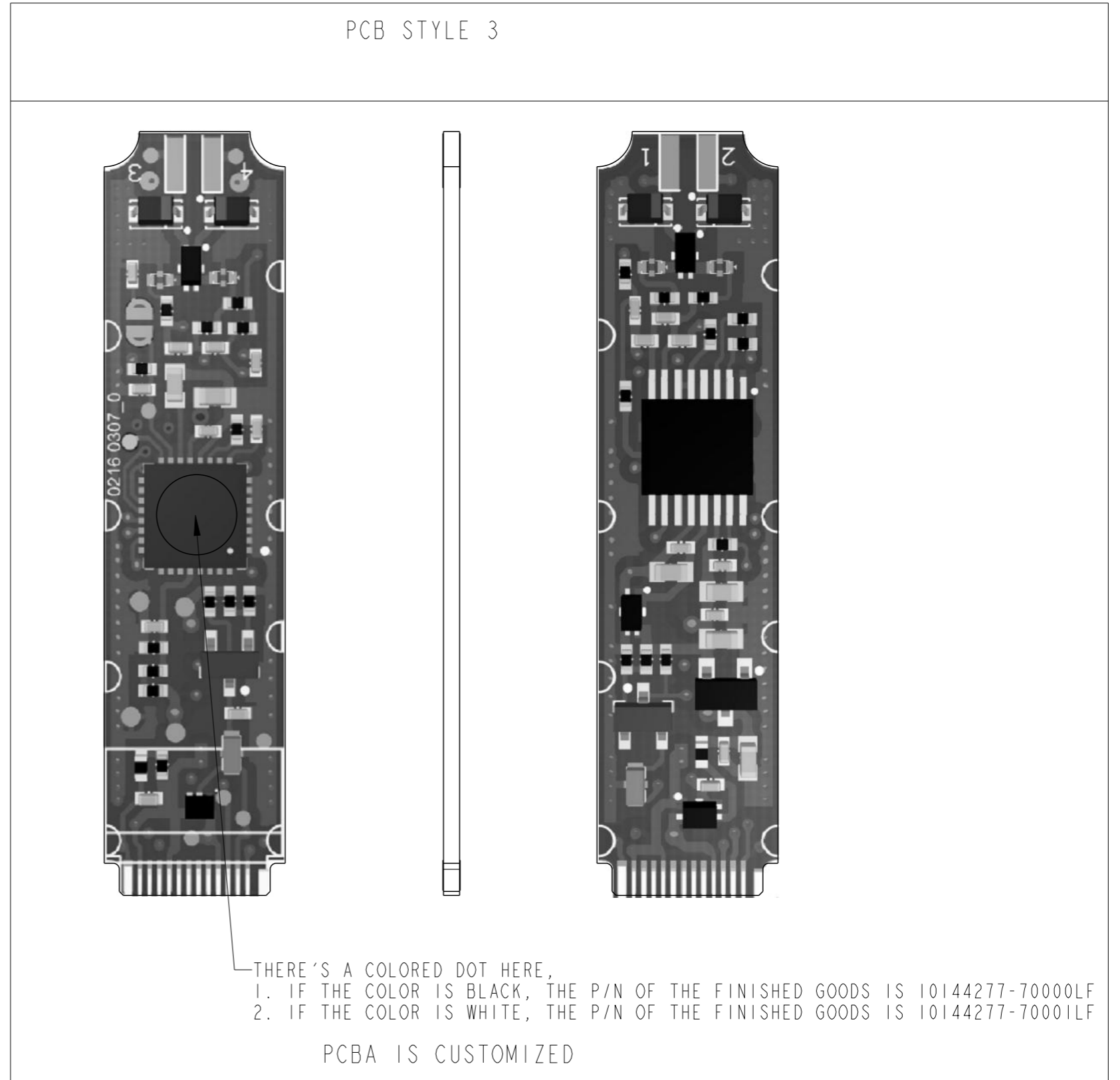
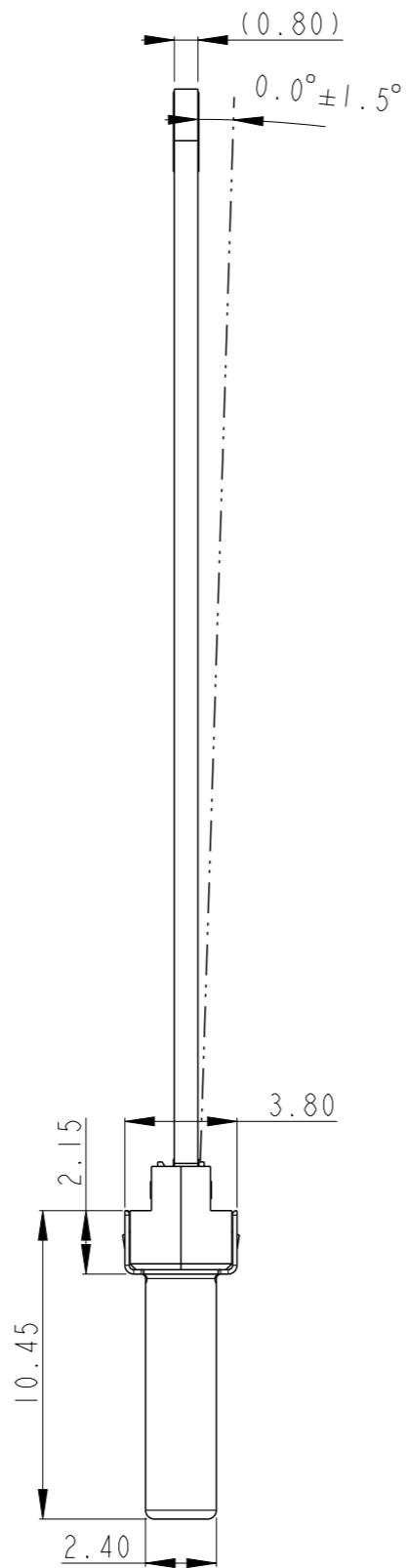
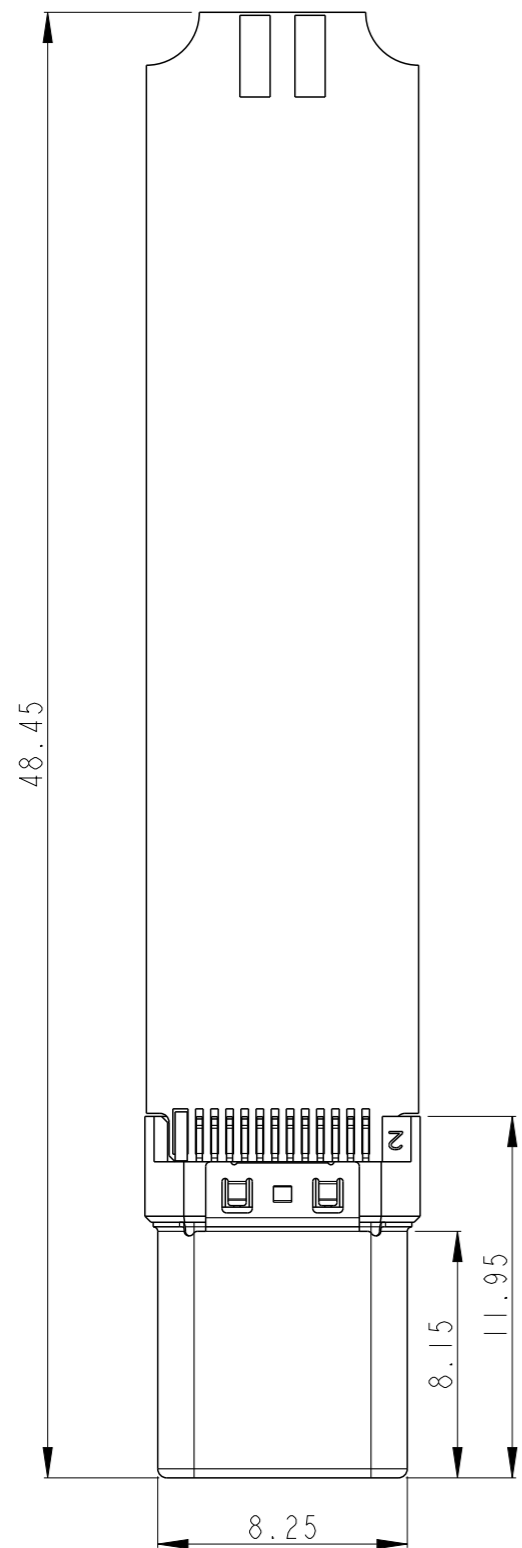

spec ref	-	dr	Li-Qing Lei	2017/06/13	projection	mm	size	A3	scale	1.000
tolerance std	ISO 406 ISO 1101	eng	Li-Qing Lei	2026/05/07			ecn no	ELX-N-288051-1	rel lev PDF Released	
TOLERANCES UNLESS OTHERWISE SPECIFIED		chr	-	-			product family			
surface	linear	appr	Tim Yao	2026/05/07	USB Type-C CABLE PLUG KITS		rel lev	10144277	rev	G
ISO 1302	angular			cat. no.	Product - Customer Drw		sheet 7 of 8			

Amphenol
FCi

© 2020 Amphenol Corporation

PART MUMBER
10144277-80000LF

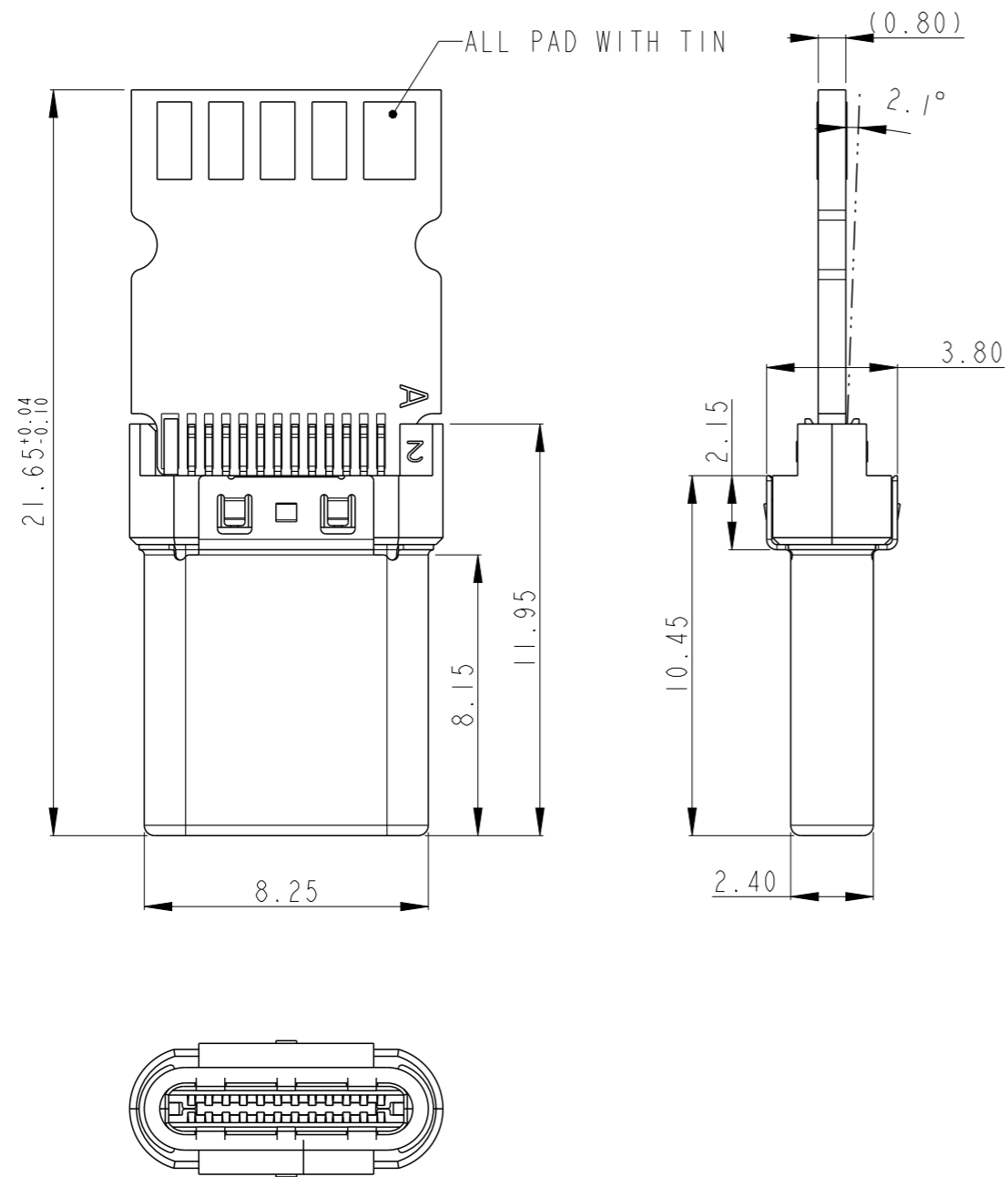

PCB STYLE 8

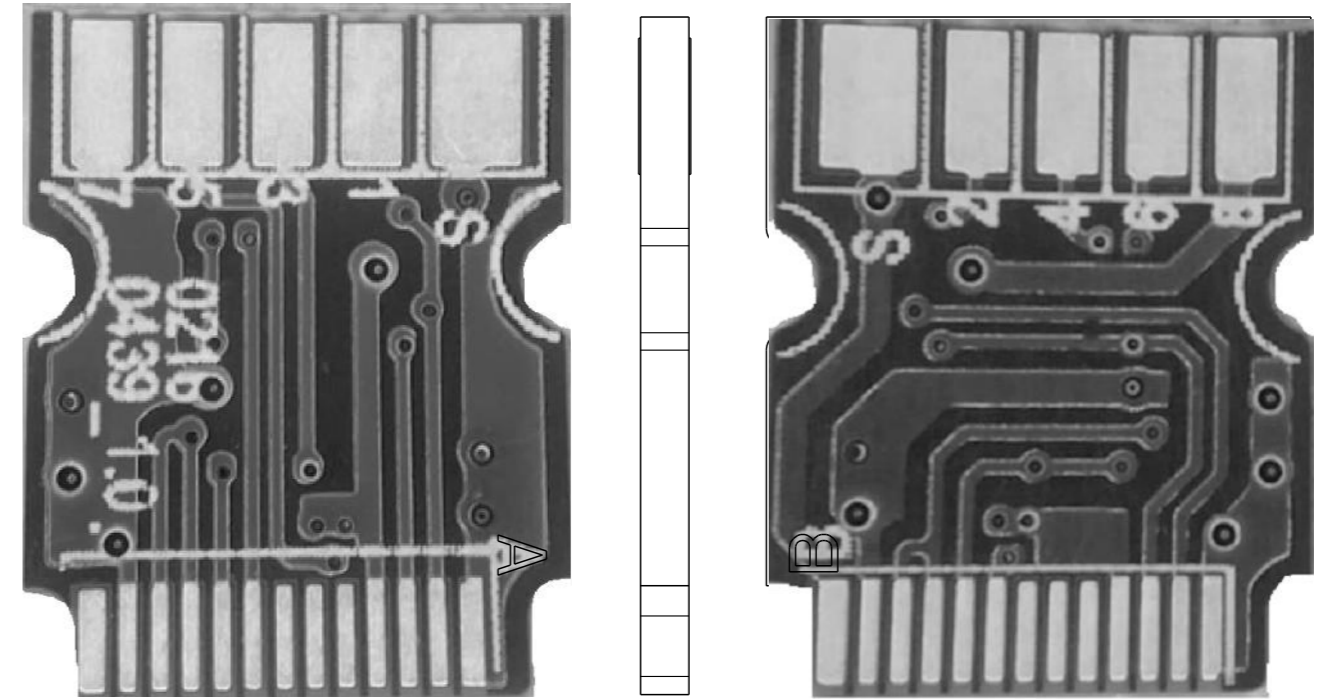

1. MATERIAL: FR-4, DOUBLE LAYER;
2. CU THICKNESS: 1 OZ
3. SURFACE TREATMENT: IMMERSION GOLD

Amphenol
FCi

© 2020 Amphenol Corporation

spec ref -		dr	Li-Qing Lei	2017/06/13	projection	mm	size	A3	scale	4.000
tolerance std ISO 406 ISO 1101		eng	Li-Qing Lei	2026/05/07			ecn no	ELX-N-288051-1		
TOLERANCES UNLESS OTHERWISE SPECIFIED		chr	-	-	product family		rel lev	PDF	Released	
		appr	Tim Yao	2026/05/07	USB Type-C CABLE PLUG KITS		dwg no	10144277	rev	G
surface	linear	0.X	±0.35	Amphenol FCi	cat. no.	Product - Customer Drw	sheet 8 of 8			
		0.XX	±0.25							
		0.XXX	±0.15							
	angular	0°	±2°							