

POLARIZATION VIEW

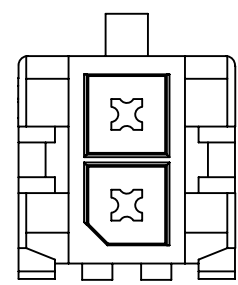

2CKT

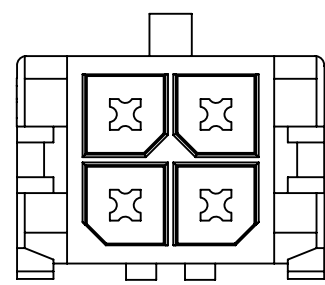

4CKT

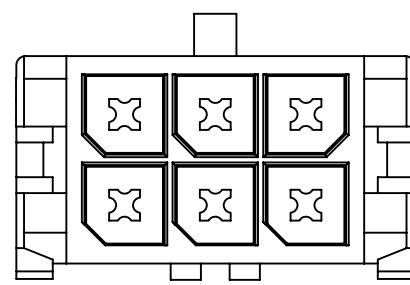

6CKT

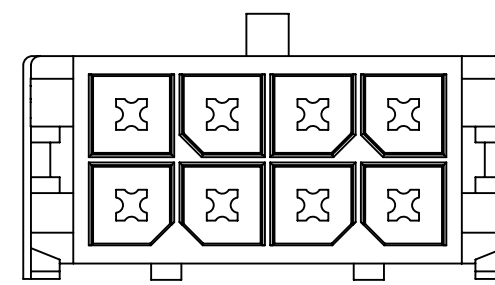

8CKT

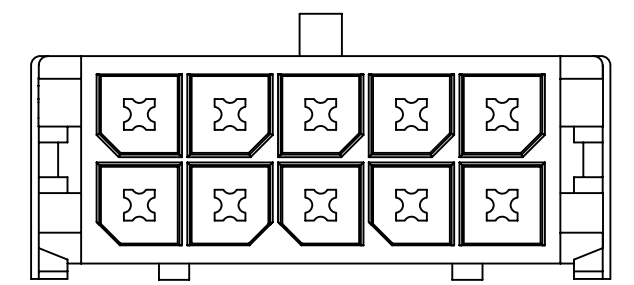

10CKT

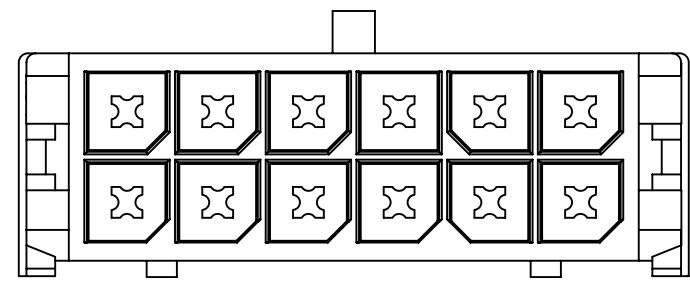

12CKT

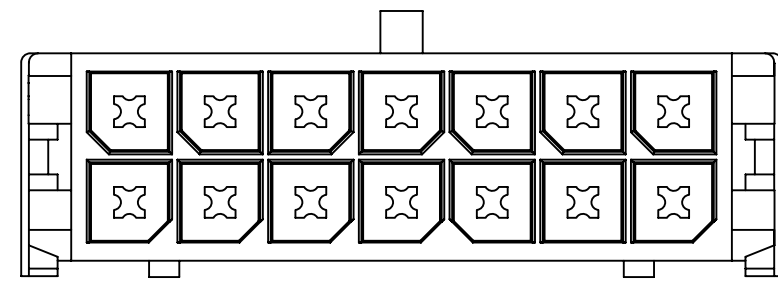

14CKT

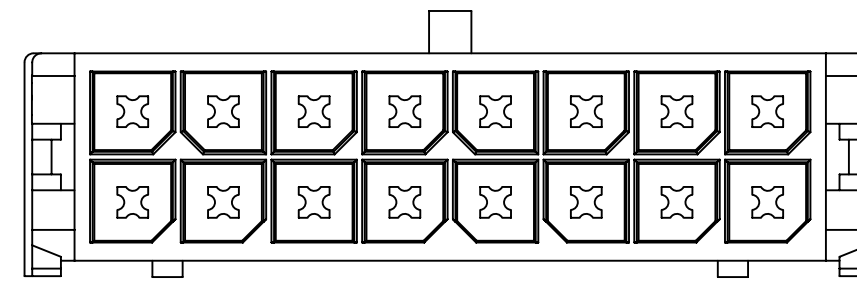

16CKT

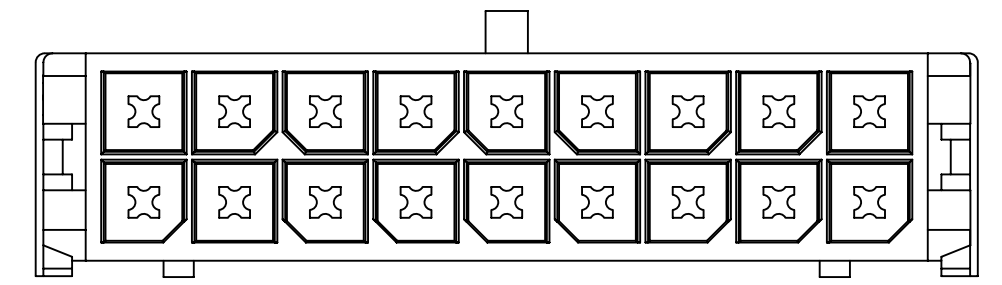

18CKT

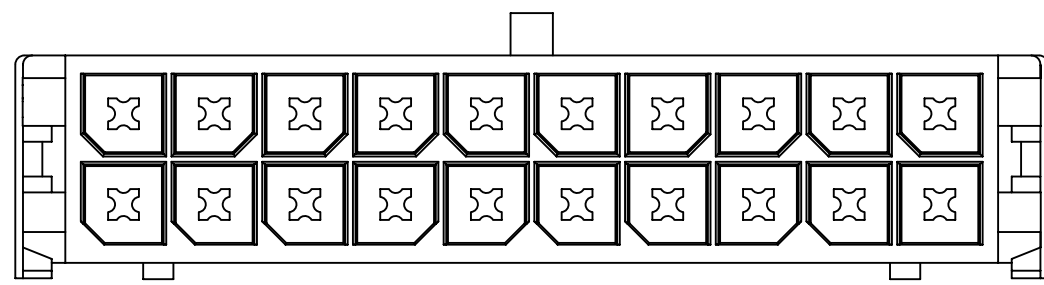

20CKT

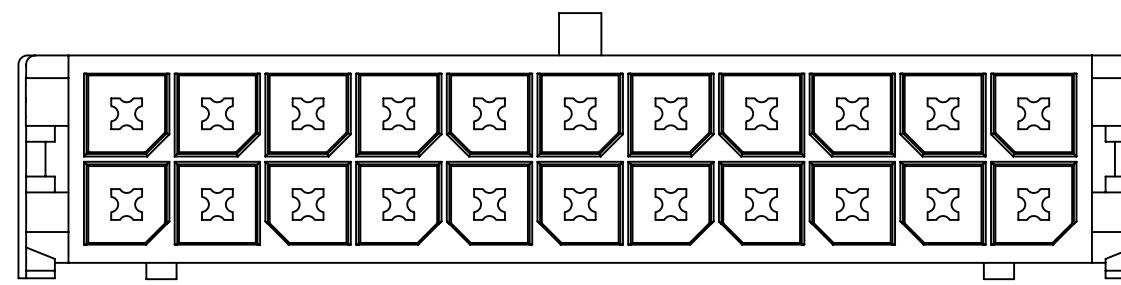

22CKT

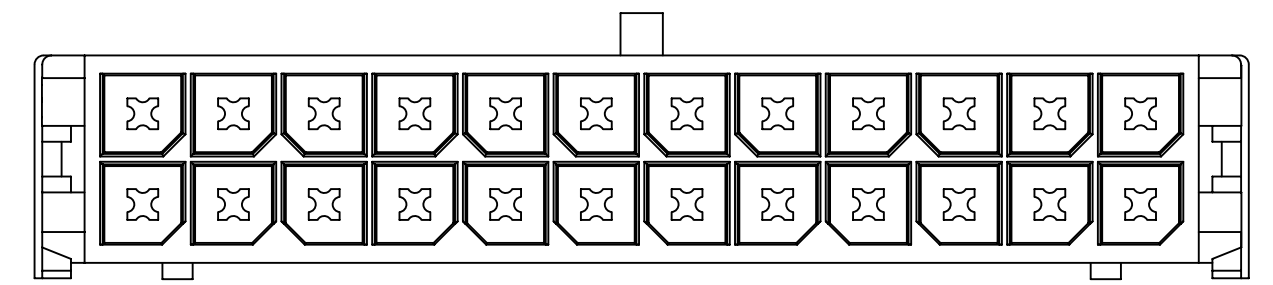

12CKT

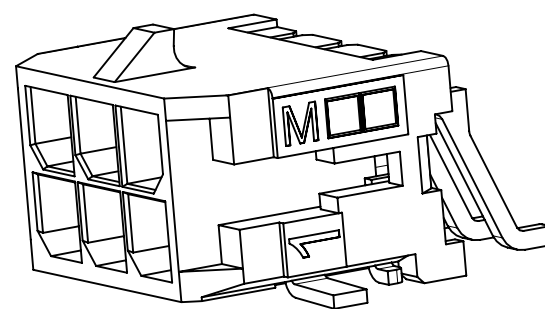
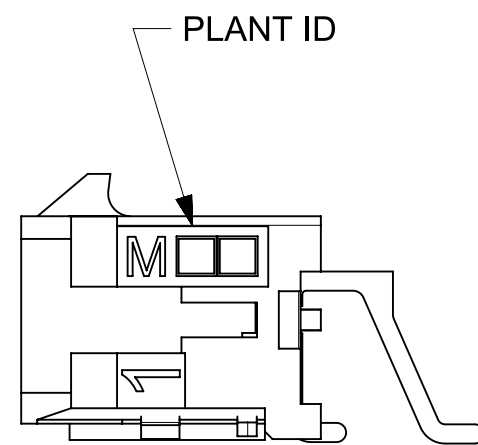
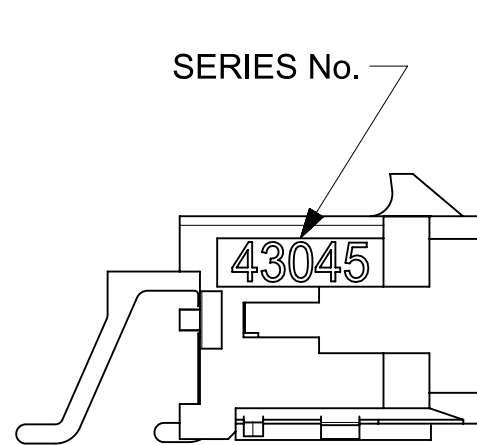

THIS DRAWING CONTAINS INFORMATION THAT IS PROPRIETARY TO MOLEX ELECTRONIC TECHNOLOGIES, LLC AND SHOULD NOT BE USED WITHOUT WRITTEN PERMISSION									
DIMENSION UNITS		SCALE		CURRENT REV DESC: 1.ADD THE PLANT ID AND SERIES NO VIEW 2.ADD POLARIZATION VIEW					
INCH/MM		NTS		STATUS: Production DRWN: Zi Xuan Qin 2026-04-14 CHK'D: Zi Xuan Qin 2026-04-24 APPR: Xue Qing Zhang 2026-04-24 INITIAL REVISION: DRWN: SAMIEC 2000/03/15 APPR: FSMITH 2016/02/26					
GENERAL TOLERANCES (UNLESS SPECIFIED)									
	MM	INCH							
4 PLACES	±	±							
3 PLACES	±	± 0.0100							
2 PLACES	± 0.250	± 0.014							
1 PLACE	± 0.36	±							
0 PLACES	±	±							
ANGULAR TOL	± 0.5°								
DRAFT WHERE APPLICABLE MUST REMAIN WITHIN DIMENSIONS		THIRD ANGLE PROJECTION		DRAWING		SERIES		DOCUMENT NUMBER	
				C-SIZE		43045		SD-43045-004	
				MATERIAL NUMBER		CUSTOMER		DOC TYPE DOC PART REVISION	
				SEE CHART		GENERAL MARKET		PSD 000 G8	
								SHEET NUMBER	
								2 OF 2	

molex

MICRO FIT (3.0) RIGHT ANGLE SMT, NAILS
DUAL ROW HEADER

PRODUCT CUSTOMER DRAWING

SD-43045-004

PSD 000 G8

SEE CHART GENERAL MARKET 2 OF 2