

DFMC 0,5/ 8-ST-2,54 - PCB connector

1844633

<https://www.phoenixcontact.com/us/products/1844633>

Please be informed that the data shown in this PDF document is generated from our online catalog. Please find the complete data in the user documentation. Our general terms of use for downloads are valid.



SIZE



0,5 mm²



Push-in



BOX

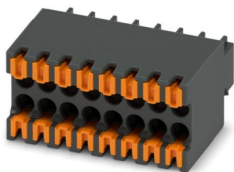

PCB connector, nominal cross section: 0.5 mm², color: black, nominal current: 6 A, rated voltage (III/2): 160 V, contact surface: Au, contact connection type: Socket, number of potentials: 16, number of rows: 2, number of positions: 8, number of connections: 16, product range: DFMC 0,5/..-ST, pitch: 2.54 mm, connection method: Push-in spring connection, conductor/PCB connection direction: 0 °, plug-in system: COMBICON DFMC 0,5, locking: without, mounting method: without, type of packaging: packed in cardboard

Your advantages

- Gold-plated contacts ensure transfer quality remains stable over the long term
- Time saving push-in connection, tools not required
- Defined contact force ensures that contact remains stable over the long term
- Intuitive operation due to color-coded actuating push button
- Optimized for tight installation situations: operation and conductor connection from one direction

Commercial data

Item number	1844633
Packing unit	50 pc
Minimum order quantity	50 pc
Sales key	AA01
Product key	AAAFDA
GTIN	4046356964319
Weight per piece (including packing)	4.44 g
Weight per piece (excluding packing)	3.97 g
Customs tariff number	85366990
Country of origin	PL

DFMC 0,5/ 8-ST-2,54 - PCB connector



1844633

<https://www.phoenixcontact.com/us/products/1844633>

Technical data

Product properties

Product type	PCB connector
Product family	DFMC 0,5/..-ST
Product line	COMBICON Connectors XS
Type	Standard
Number of positions	8
Pitch	2.54 mm
Number of connections	16
Number of rows	2
Number of potentials	16
Mounting type	without

Electrical properties

Properties

Nominal current I_N	6 A
Nominal voltage U_N	160 V
Contact resistance	2.7 m Ω
Rated voltage (III/3)	32 V
Rated surge voltage (III/3)	0.8 kV
Rated voltage (III/2)	160 V
Rated surge voltage (III/2)	2.5 kV
Rated voltage (II/2)	160 V
Rated surge voltage (II/2)	1.5 kV

Connection data

Connection technology

Type	Standard
Connector system	COMBICON DFMC 0,5
Nominal cross section	0.5 mm ²
Contact connection type	Socket

Interlock

Locking type	without
Mounting type	without

Conductor connection

Connection method	Push-in spring connection
Conductor/PCB connection direction	0 °
Conductor cross-section rigid	0.14 mm ² ... 0.5 mm ²
Conductor cross-section flexible	0.14 mm ² ... 0.5 mm ²
Conductor cross-section AWG	26 ... 20

DFMC 0,5/ 8-ST-2,54 - PCB connector

1844633

<https://www.phoenixcontact.com/us/products/1844633>

Conductor cross-section, flexible, with ferrule, without plastic sleeve	0.25 mm ² ... 0.34 mm ²
Conductor cross-section, flexible, with ferrule, with plastic sleeve	0.14 mm ² ... 0.25 mm ²
Cylindrical gauge a x b / diameter	- / 1.2 mm
Stripping length	7 mm

Material specifications

Material data - contact

Note	WEEE/RoHS-compliant, free of whiskers according to IEC 60068-2-82/JEDEC JESD 201
Contact material	Cu alloy
Surface characteristics	partially gold-plated
Metal surface terminal point (top layer)	Tin (5 µm - 7 µm Sn)
Metal surface terminal point (middle layer)	Nickel (2 µm - 3 µm Ni)
Metal surface contact area (top layer)	Gold (min. 0.25 µm Au)
Metal surface contact area (middle layer)	Nickel (2 µm - 3 µm Ni)

Material data - housing

Color (Housing)	black (9005)
Insulating material	LCP
Insulating material group	IIIa
CTI according to IEC 60112	175
Flammability rating according to UL 94	V0

Material data – actuating element

Color (Actuating element)	orange (2003)
Insulating material	LCP
Insulating material group	IIIa
CTI according to IEC 60112	175
Flammability rating according to UL 94	V0

Dimensions

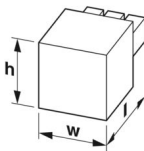
Dimensional drawing	
Pitch	2.54 mm
Width [w]	20.82 mm
Height [h]	10.5 mm
Length [l]	15.85 mm

Notes

DFMC 0,5/ 8-ST-2,54 - PCB connector



1844633

<https://www.phoenixcontact.com/us/products/1844633>

Notes on operation	In accordance with IEC 61984, COMBICON connectors have no switching power (COC). During designated use, they must not be plugged in or disconnected when carrying voltage or under load.
--------------------	--

Mechanical tests

Conductor connection

Specification	IEC 60999-1:1999-11
Result	Test passed

Test for conductor damage and slackening

Specification	IEC 60999-1:1999-11
Result	Test passed

Repeated connection and disconnection

Specification	IEC 60999-1:1999-11
Result	Test passed

Pull-out test

Specification	IEC 60999-1:1999-11
Conductor cross-section/conductor type/tractive force setpoint/actual value	0.14 mm ² / solid / > 10 N
	0.14 mm ² / flexible / > 10 N
	0.5 mm ² / solid / > 20 N
	0.5 mm ² / flexible / > 20 N

Insertion and withdrawal forces

Specification	IEC 60512-13-2:2006-02
Result	Test passed
No. of cycles	100
Insertion strength per pos. approx.	2 N
Withdraw strength per pos. approx.	1 N

Resistance of inscriptions

Specification	IEC 60068-2-70:1995-12
Result	Test passed

Polarization and coding

Specification	IEC 60512-13-5:2006-02
Result	Test passed

Visual inspection

Specification	IEC 60512-1-1:2002-02
Result	Test passed

Dimension check

Specification	IEC 60512-1-2:2002-02
Result	Test passed

Environmental and real-life conditions

DFMC 0,5/ 8-ST-2,54 - PCB connector



1844633

<https://www.phoenixcontact.com/us/products/1844633>

Durability test

Specification	IEC 60512-9-1:2010-03
Impulse withstand voltage at sea level	2.95 kV
Contact resistance R ₁	2.7 mΩ
Contact resistance R ₂	2.9 mΩ
Contact resistance R ₂ 2nd level	3.1 mΩ
Insertion/withdrawal cycles	100
Insulation resistance, neighboring positions	> 5 MΩ

Climatic test

Specification	DIN 50018:2013-05
Corrosive stress	1.0 dm ³ SO ₂ on 300 dm ³ /40 °C/3 cycles
Thermal stress	100 °C/168 h
Power-frequency withstand voltage	1.39 kV

Vibration test

Specification	IEC 60068-2-6:2007-12
Frequency	10 - 500 - 10 Hz
Sweep speed	1 octave/min
Amplitude	0.35 mm (10 Hz ... 60.1 Hz)
Acceleration	5g (60.1 Hz ... 500 Hz)
Test duration per axis	2 h
Test directions	X-, Y- and Z-axis

Ambient conditions

Ambient temperature (storage/transport)	-40 °C ... 70 °C
Relative humidity (storage/transport)	30 % ... 70 %
Ambient temperature (assembly)	-5 °C ... 100 °C
Ambient temperature (operation)	-40 °C ... 100 °C (dependent on the derating curve)

Electrical tests

Thermal test | Test group C

Specification	IEC 60512-5-1:2002-02
Tested number of positions	16

Insulation resistance

Specification	IEC 60512-3-1:2002-02
Insulation resistance, neighboring positions	> 5 MΩ

Temperature cycles

Specification	IEC 60999-1:1999-11
Result	Test passed

Air clearances and creepage distances |

Specification	IEC 60664-1:2007-04
Insulating material group	IIIa

DFMC 0,5/ 8-ST-2,54 - PCB connector



1844633

<https://www.phoenixcontact.com/us/products/1844633>

Comparative tracking index (IEC 60112)	CTI 175
Rated insulation voltage (III/3)	32 V
Rated surge voltage (III/3)	0.8 kV
minimum clearance value - non-homogenous field (III/3)	0.8 mm
minimum creepage distance (III/3)	1.3 mm
Rated insulation voltage (III/2)	160 V
Rated surge voltage (III/2)	2.5 kV
minimum clearance value - non-homogenous field (III/2)	1.5 mm
minimum creepage distance (III/2)	1.6 mm
Rated insulation voltage (II/2)	160 V
Rated surge voltage (II/2)	1.5 kV
minimum clearance value - non-homogenous field (II/2)	0.5 mm
minimum creepage distance (II/2)	1.6 mm

Packaging specifications

Type of packaging	packed in cardboard
-------------------	---------------------

Drawings

Diagram

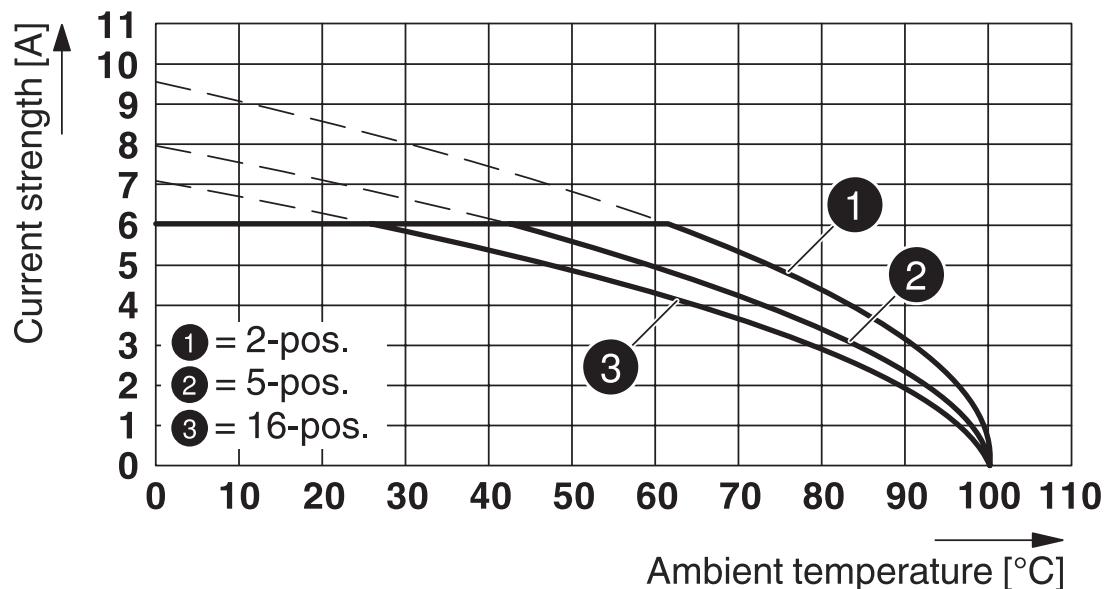

Type: DFMC 0,5/...-ST-2,54 with DMC 0,5/...-G1-2,54 P...THR R...

Diagram

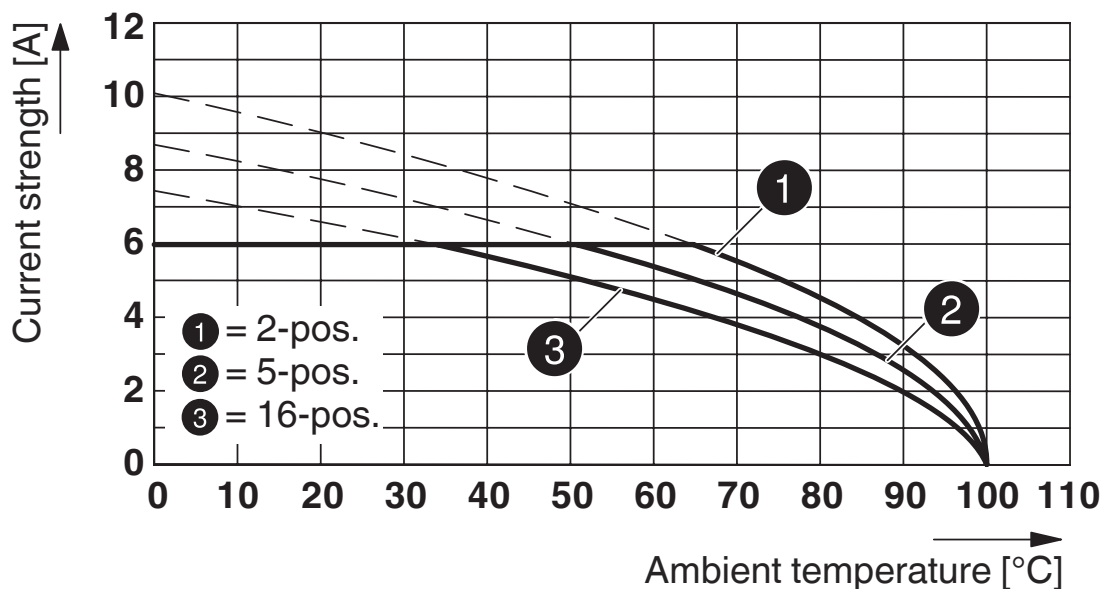

Type: DFMC 0,5/...-ST-2,54 with DMCV 0,5/...-G1-2,54 P... THRR...

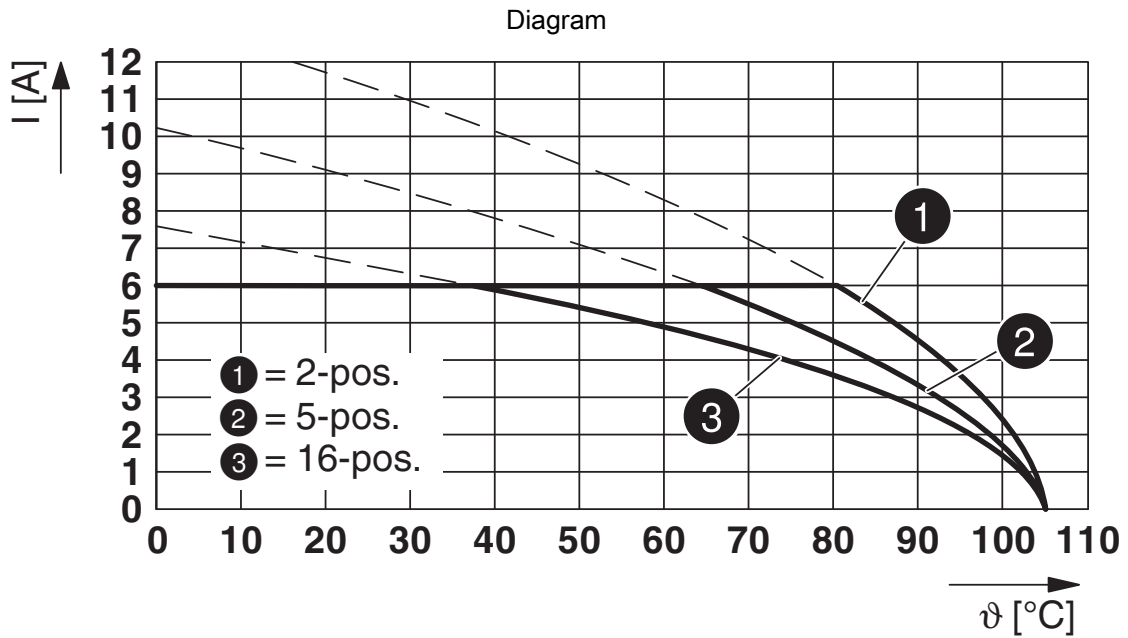

Type: DFMC 0,5/...-ST-2,54 with DMC 0,5/...-G1-2,54 SMD R...

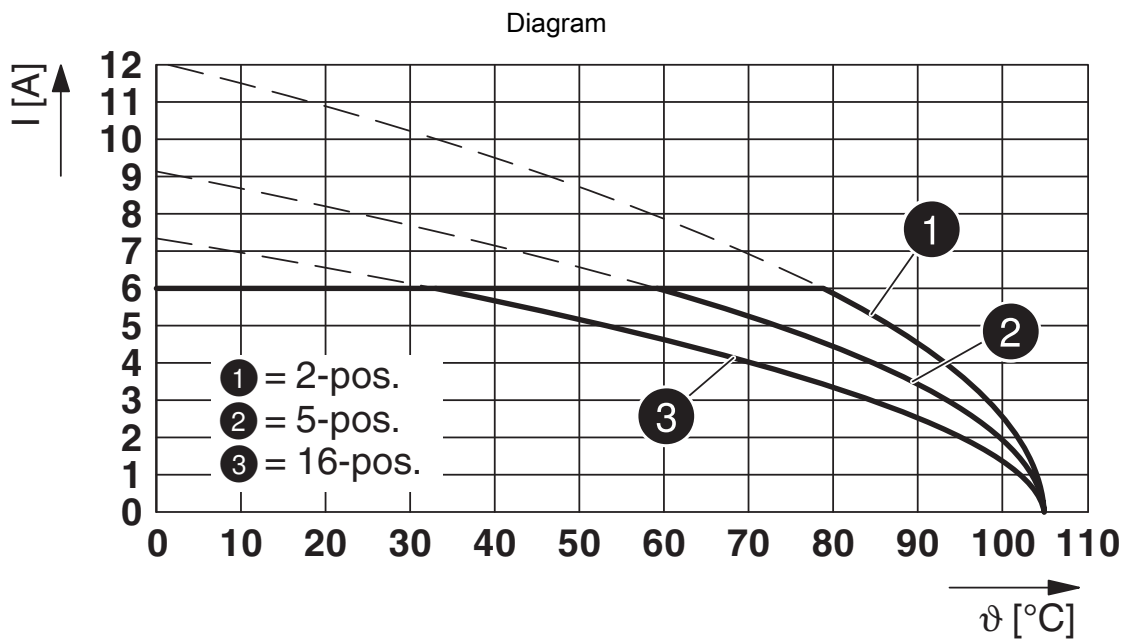

Type: DFMC 0,5/...-ST-2,54 with DMCV 0,5/...-G1-2,54 SMD R...

DFMC 0,5/ 8-ST-2,54 - PCB connector



1844633

<https://www.phoenixcontact.com/us/products/1844633>

Approvals

To download certificates, visit the product detail page: <https://www.phoenixcontact.com/us/products/1844633>

 cULus Recognized Approval ID: E60425-19920306				
	Nominal voltage U_N	Nominal current I_N	Cross section AWG	Cross section mm^2
B				
Field wiring	150 V	5 A	26 - 20	-
Factory wiring	150 V	6 A	26 - 20	-
C				
Factory wiring	50 V	6 A	26 - 20	-

 VDE report with production monitoring Approval ID: 40042389				
	Nominal voltage U_N	Nominal current I_N	Cross section AWG	Cross section mm^2
keine				
	160 V	6 A	-	0.14 - 0.5

DFMC 0,5/ 8-ST-2,54 - PCB connector



1844633

<https://www.phoenixcontact.com/us/products/1844633>

Classifications

ECLASS

ECLASS-13.0	27460202
ECLASS-15.0	27460202

ETIM

ETIM 10.0	EC002638
-----------	----------

UNSPSC

UNSPSC 21.0	39121400
-------------	----------

DFMC 0,5/ 8-ST-2,54 - PCB connector



1844633

<https://www.phoenixcontact.com/us/products/1844633>

Environmental product compliance

EU RoHS

Fulfills EU RoHS substance requirements	Yes, No exemptions
---	--------------------

China RoHS

Environment friendly use period (EFUP)	EFUP-E
	No hazardous substances above the limits

EU REACH SVHC

REACH candidate substance (CAS No.)	No substance above 0.1 wt%
-------------------------------------	----------------------------

EF3.1 Climate Change

CO2e kg	0.163 kg CO2e
---------	---------------

DFMC 0,5/ 8-ST-2,54 - PCB connector

1844633

<https://www.phoenixcontact.com/us/products/1844633>

Accessories

SZS 0,4X2,0 - Screwdriver

1205202

<https://www.phoenixcontact.com/us/products/1205202>



Micro screwdriver, bladed, size: 0.4 x 2.0 x 60 mm, 2-component grip, with non-slip grip and twist cap

SK 2,54/2,8:FORTL.ZAHLEN - Marker card

0804853

<https://www.phoenixcontact.com/us/products/0804853>

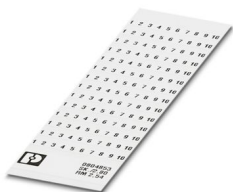

Marker card, Sheet, white (RAL 9010), labeled, horizontal: consecutive numbers 1 ... 10, 11 ... 20, etc. up to 91 ... 99, mounting type: adhesive, for terminal block width: 2.54 mm, Number of individual labels: 14, text field height: 2.8 mm, text field width: 2.54 mm

DFMC 0,5/ 8-ST-2,54 - PCB connector

1844633

<https://www.phoenixcontact.com/us/products/1844633>

A 0,25- 7 - Ferrule

3202478

<https://www.phoenixcontact.com/us/products/3202478>



Ferrule, Length contact range: 7 mm, sleeve length: 7 mm, color: silver-colored

A 0,34- 7 - Ferrule

3009202

<https://www.phoenixcontact.com/us/products/3009202>



Ferrule, Length contact range: 7 mm, sleeve length: 7 mm, color: silver-colored

DFMC 0,5/ 8-ST-2,54 - PCB connector

1844633

<https://www.phoenixcontact.com/us/products/1844633>



CRIMPFOX 6 - Crimping pliers

1212034

<https://www.phoenixcontact.com/us/products/1212034>



Crimping pliers, for ferrules without insulating collar according to DIN 46228 Part 1 and ferrules with insulating collar according to DIN 46228 Part 4, 0.25 mm² ... 6.0 mm², lateral entry, trapezoidal crimp

AI 0,25- 8 YE - Ferrule

3203037

<https://www.phoenixcontact.com/us/products/3203037>



Ferrule, Length contact range: 8 mm, sleeve length: 12.5 mm, color: yellow

DFMC 0,5/ 8-ST-2,54 - PCB connector

1844633

<https://www.phoenixcontact.com/us/products/1844633>

AI 0,25-8 YE-1000 - Ferrule

2100145

<https://www.phoenixcontact.com/us/products/2100145>



Ferrule, Length contact range: 8 mm, sleeve length: 12.5 mm, color: yellow

AI 0,25-8 VT - Ferrule

2100147

<https://www.phoenixcontact.com/us/products/2100147>



Ferrule, Length contact range: 8 mm, sleeve length: 12.5 mm, color: violet

DFMC 0,5/ 8-ST-2,54 - PCB connector

1844633

<https://www.phoenixcontact.com/us/products/1844633>

AI 0,14-8 BN - Ferrule

2100149

<https://www.phoenixcontact.com/us/products/2100149>



Ferrule, Length contact range: 8 mm, sleeve length: 12.5 mm, color: brown

AI 0,14- 8 GY -1000 - Ferrule

3203011

<https://www.phoenixcontact.com/us/products/3203011>



Ferrule, Length contact range: 8 mm, sleeve length: 12.5 mm, color: gray

DFMC 0,5/ 8-ST-2,54 - PCB connector

1844633

<https://www.phoenixcontact.com/us/products/1844633>

DMC 0,5/ 8-G1-2,54 P20THR R44 - PCB header

1844785

<https://www.phoenixcontact.com/us/products/1844785>



PCB headers, nominal cross section: 0.5 mm², color: black, nominal current: 6 A, rated voltage (III/2): 160 V, contact surface: Au, contact connection type: Pin, number of potentials: 16, number of rows: 2, number of positions: 8, number of connections: 16, product range: DMC 0,5/..-G1-THR, pitch: 2.54 mm, mounting: THR soldering / wave soldering, pin layout: Linear pinning, solder pin [P]: 2 mm, number of solder pins per potential: 1, plug-in system: COMBICON DFMC 0,5, Pin connector pattern alignment: Standard, locking: without, mounting method: without, type of packaging: 44 mm wide tape

DMCV 0,5/ 8-G1-2,54 P20THR R44 - PCB header

1844934

<https://www.phoenixcontact.com/us/products/1844934>

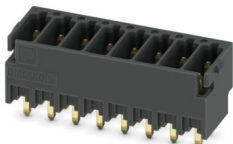

PCB headers, nominal cross section: 0.5 mm², color: black, nominal current: 6 A, rated voltage (III/2): 160 V, contact surface: Au, contact connection type: Pin, number of potentials: 16, number of rows: 2, number of positions: 8, number of connections: 16, product range: DMCV 0,5/..-G1-THR, pitch: 2.54 mm, mounting: THR soldering / wave soldering, pin layout: Linear pinning, solder pin [P]: 2 mm, number of solder pins per potential: 1, plug-in system: COMBICON DFMC 0,5, Pin connector pattern alignment: Standard, locking: without, mounting method: without, type of packaging: 44 mm wide tape

DFMC 0,5/ 8-ST-2,54 - PCB connector



1844633

<https://www.phoenixcontact.com/us/products/1844633>

DMC 0,5/ 8-G1-2,54 SMD R44 - PCB header

1845085

<https://www.phoenixcontact.com/us/products/1845085>



PCB headers, nominal cross section: 0.5 mm^2 , color: black, nominal current: 6 A, rated voltage (III/2): 160 V, contact surface: Au, contact connection type: Pin, number of potentials: 16, number of rows: 2, number of positions: 8, number of connections: 16, product range: DMC 0,5/...-G1-SMD, pitch: 2.54 mm, mounting: SMD soldering, pin layout: Linear pad geometry, number of solder pins per potential: 1, plug-in system: COMBICON DFMC 0,5, Pin connector pattern alignment: Standard, locking: without, mounting method: without, type of packaging: 44 mm wide tape

DMCV 0,5/ 8-G1-2,54 SMD R44 - PCB header

1845234

<https://www.phoenixcontact.com/us/products/1845234>



PCB headers, nominal cross section: 0.5 mm^2 , color: black, nominal current: 6 A, rated voltage (III/2): 160 V, contact surface: Au, contact connection type: Pin, number of potentials: 16, number of rows: 2, number of positions: 8, number of connections: 16, product range: DMCV 0,5/...-G1-SMD, pitch: 2.54 mm, mounting: SMD soldering, pin layout: Linear pad geometry, number of solder pins per potential: 1, plug-in system: COMBICON DFMC 0,5, Pin connector pattern alignment: Standard, locking: without, mounting method: without, type of packaging: 44 mm wide tape

Phoenix Contact 2026 © - all rights reserved
<https://www.phoenixcontact.com>

Phoenix Contact USA
586 Fulling Mill Road
Middletown, PA 17057, United States
(+717) 944-1300
info@phoenixcon.com