

LOC	DIST	REVISIONS					
ES	00	P	LTN	DESCRIPTION	DATE	DWN	APVD
		B6		ECR-23-192475	15NOV2023	TL	FL
		B7		REVISED PER ECR-24-230188	24DEC2024	DK	FL
		B8		ECR-25-264356	12DEC2025	AA	FL
		B9		ECR-26-272902	10MAR2026	AA	FL

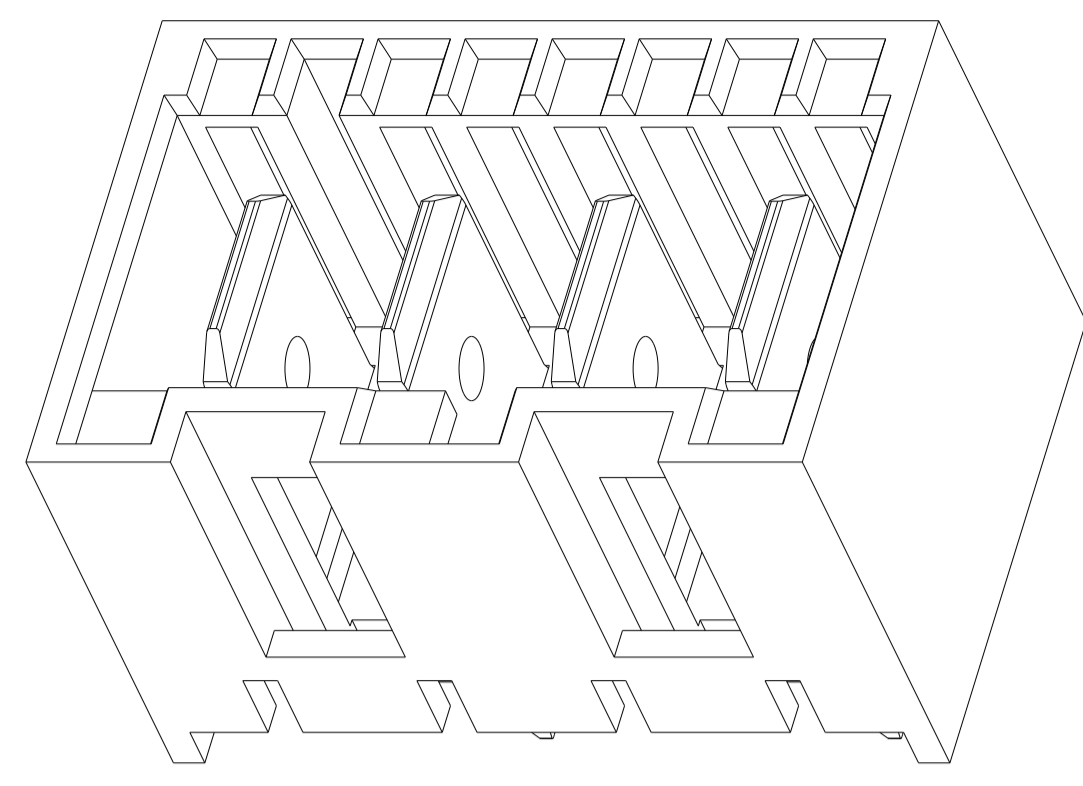

NOTE

- HOUSING HAS RAST 5 COMPLIANT KEYING, LATCHING, AND POLARIZATION TAB IS 6.30 X 0.8 ACCORDING TO DIN 46244
- SEE SHEET 2 FOR AVAILABLE CONFIGURATIONS
- MATERIAL: HOUSING, NYLON, UL94 V0, 750°C GWT NO FLAME CONTACT, COPPER ALLOY, 0.8MM THICK
- FINISH: CONTACTS, MATT TIN PLATING OVERALL, NICKEL UNDER-PLATING BRIGHT TIN PLATING OVERALL, NICKEL UNDER-PLATING SILVER PLATING OVERALL, NICKEL UNDER-PLATING
- PCB TABS INSERTED IN A STAGGERED PATTERN BEGINNING WITH POSITION 1 (Cct1)
- THE PART NUMBERS SHOWING IN SHEET 2 & 3 & 4 & 5 ARE FOR NATURAL COLOR. THE PART NUMBER FOR OTHER COLOR ARE BASED ON THE NATURAL ONE: FOR THE SAME CONFIGURATION, THE PREFIX AND POSTFIX OF THE P/N ARE THE SAME, ONLY THE BASE NUMBER IS DIFFERENT ACCORDING TO DIFFERENT COLOR, DETAIL PLEASE SEE SHEET 6
- PACKAGING: LOOSE PIECE OR TUBE. THE PART NUMBERS IN THIS DRAWING ARE WITH LOOSE PIECE PACKAGING. PLEASE CONTACT TE SALES REPRESENTATIVES FOR TUBE PACKAGING REQUIREMENT.
- PRELIMINARY PART, NOT RELEASED FOR PRODUCTION.
- FOR P/N: 2-1971895-4:
 1) THE CONTACTS ARE WITH BRIGHT TIN PLATING
 2) INSERTION FORCE MATING WITH 4P MONO SHAPE MKI CONNECTOR: 85N MAX ACCORDING TO IEC 60512-13-1, Test 13a.
- FOR P/N: 5-1971845-8, 2-1971845-6, 6-1971845-5 AND 2-1971895-5:
 1) THE CONTACTS ARE WITH BRIGHT TIN PLATING.
- PART NUMBERS WITH TUBE PACKAGING

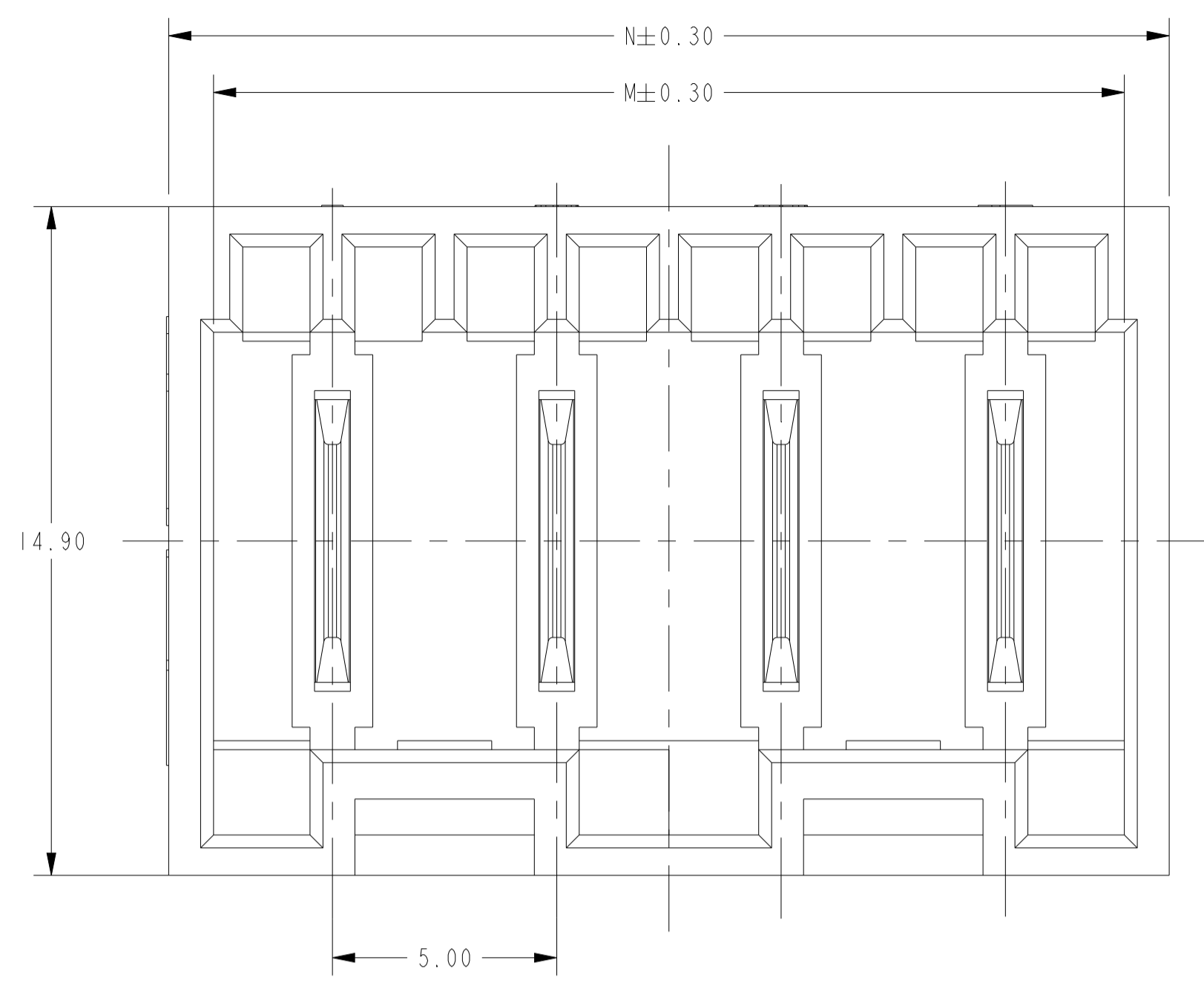
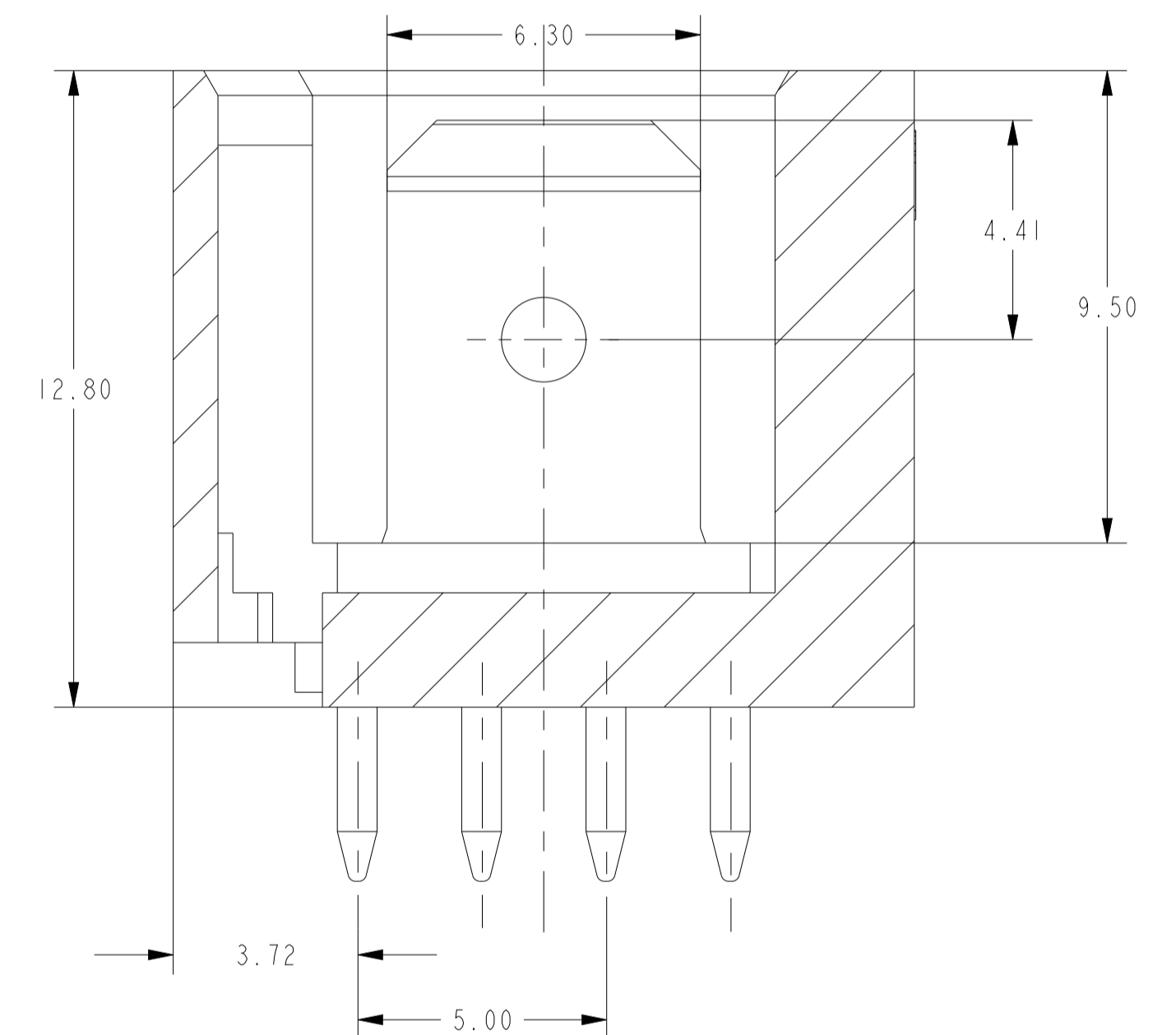
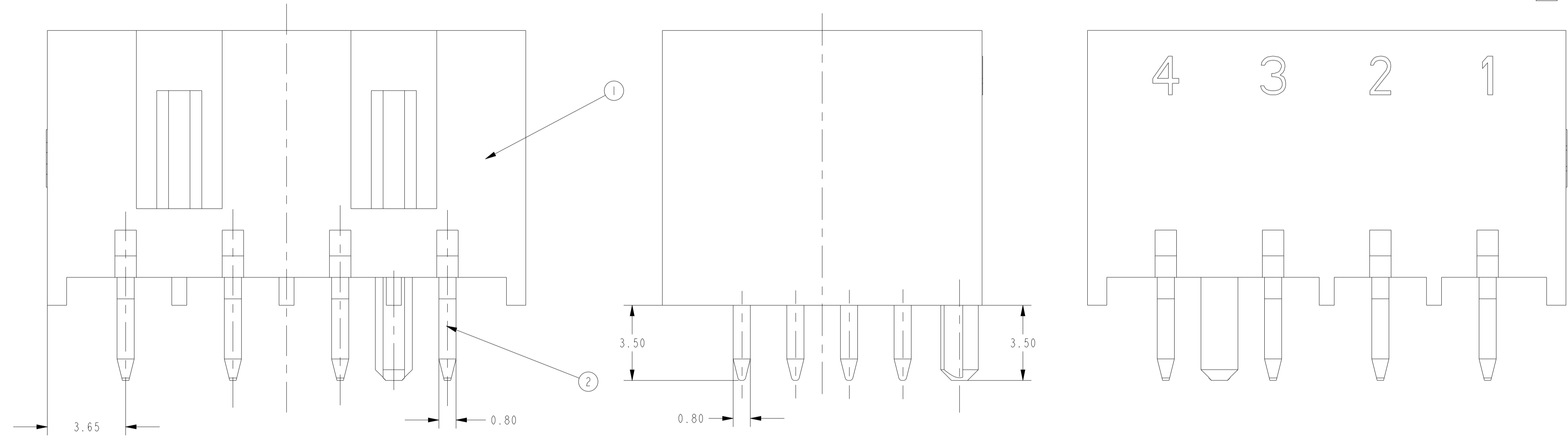

SECTION A-A

- TOOL MARK ON TERMINAL SURFACE IS ACCEPTABLE WHICH DOES NOT IMPACT FUNCTION
- PACKAGING WITH NORMAL PE BAG
- THREE ALTERNATIVE RESIN, COMPLAINT TO UL97-V0, GWT 750°C NO FLAME

42.30	40.30	8
37.30	35.30	7
32.30	30.30	6
27.30	25.30	5
22.30	20.30	4
17.30	15.30	3
12.30	10.30	2
N	M	NO. OF POS.

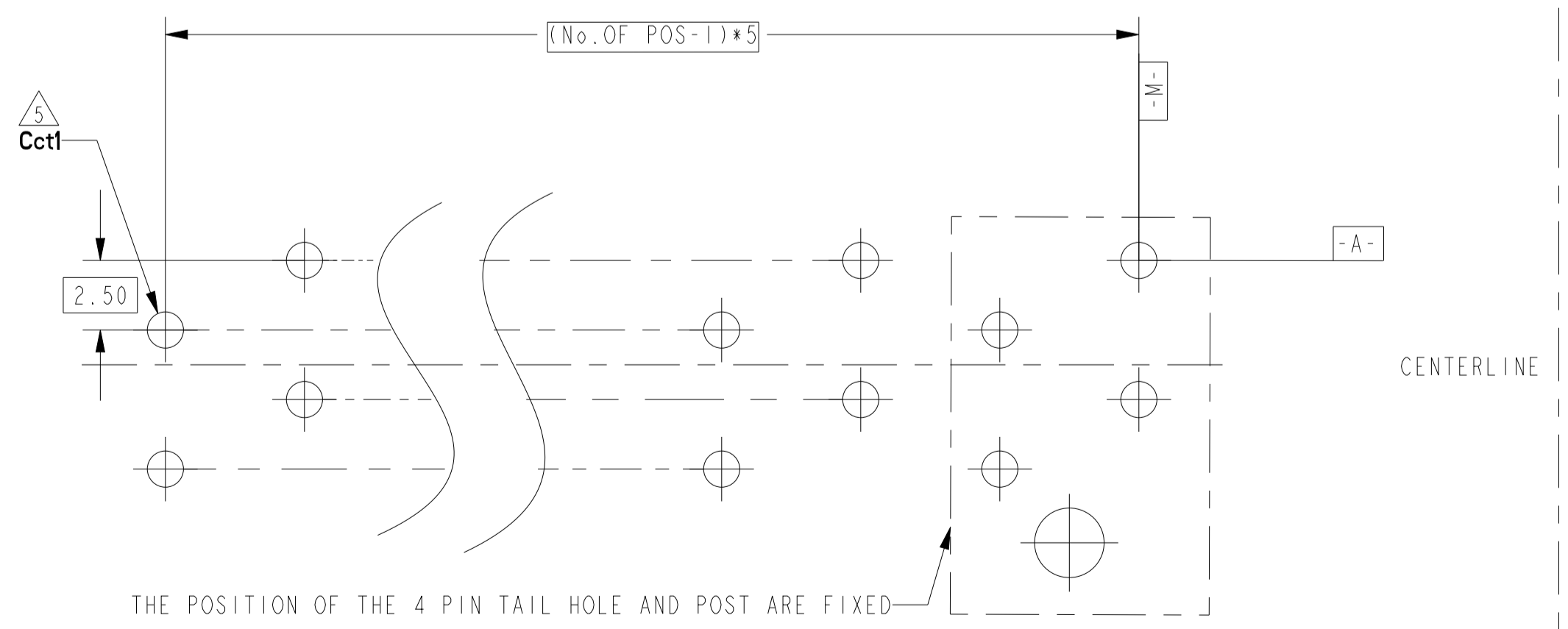

RECOMMEND PCB LAYOUT - SOLDER SIDE
 EVEN NUMBER OF PINS
 PCB 15±0.2 THICK

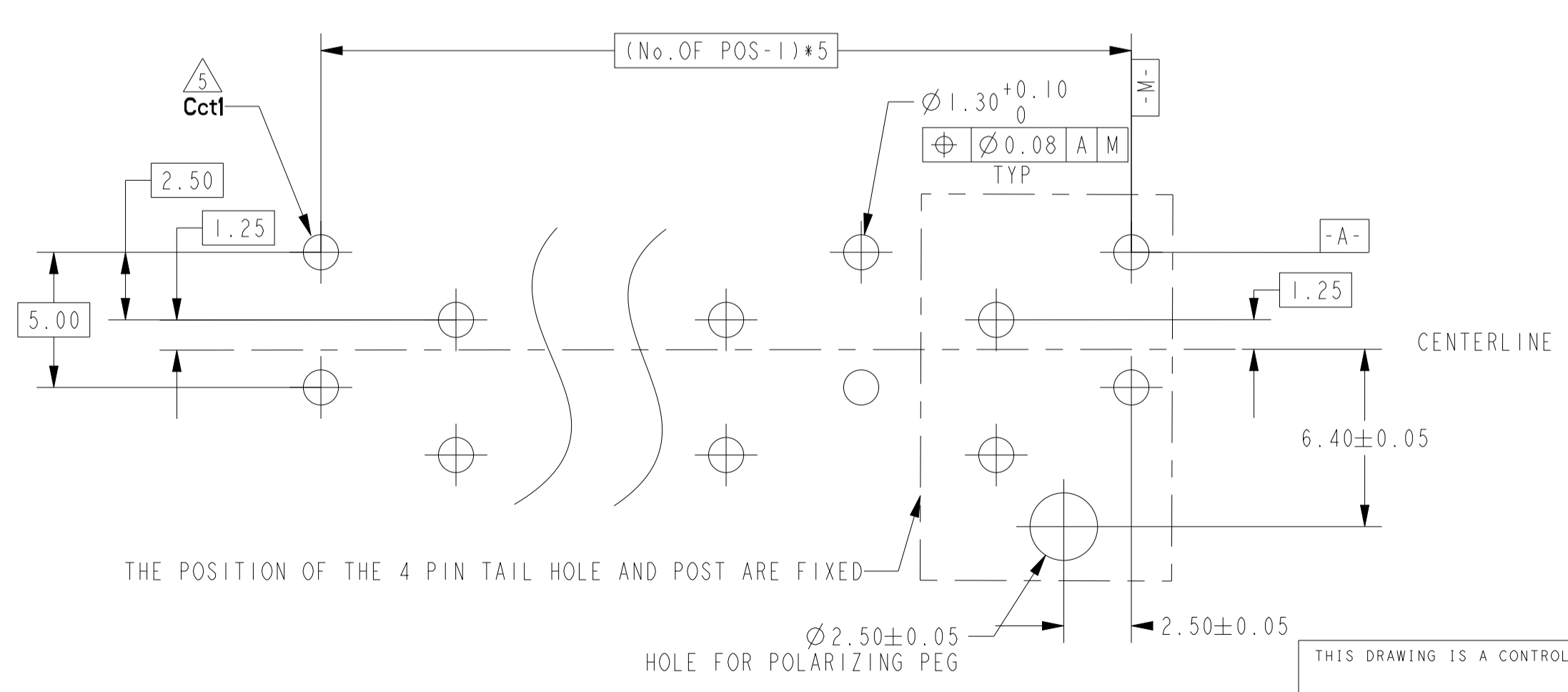

RECOMMEND PCB LAYOUT - SOLDER SIDE
 ODD NUMBER OF PINS
 PCB 15±0.2 THICK

THIS DRAWING IS A CONTROLLED DOCUMENT.

DIMENSIONS:	TOLERANCES UNLESS OTHERWISE SPECIFIED:	DWN: HRP 21Jan2013	CHK: HAPYE 21Jan2013
mm	0 PLC ±	APVD: YHM 21Jan2013	NAME: RAST 5 TAB HEADER ASSY
	1 PLC ±	PRODUCT SPEC	DIN STYLE, TH, VERTICAL
	2 PLC ±0.25	APPLICATION SPEC	108-106080
	3 PLC ±	SIZE: A1	CAGE CODE: 00779
	4 PLC ±	DRAWING NO: 1971845	REV: B9
	ANGLES FINISH: ±2°	WEIGHT: -	SCALE: 8:1
MATERIAL: -	FINISH: -	Customer Drawing	SHEET 1 OF 6

LOC		DIST		REVISIONS			
P	LTN	DESCRIPTION	DATE	OWN	APVD		
		SEE SHEET 1					

color	QTY	②	QTY	①	NO. OF POS.	TE PART NO.		
NATURAL	8	TAB CONTACT MATT TIN PLATING (5-1971845-8, 6-1971845-5, 2-1971845-6 AND 2-1971895-5 WITH BRIGHT TIN)	1	8	8	6-1971845-8 5-1971845-8 Δ_{10} 4-1971845-8 3-1971845-8 2-1971845-8 1-1971845-8 1971845-8		
RED	7		1	7	7	1971946-7 1971895-7 9-1971845-7 8-1971845-7 7-1971845-7 6-1971845-7 5-1971845-7 4-1971845-7 3-1971845-7 2-1971845-7 1-1971845-7 1971845-7		
NATURAL			1	6	6	1-1971895-6 1971895-6 9-1971845-6 8-1971845-6 7-1971845-6 6-1971845-6 5-1971845-6 4-1971845-6 3-1971845-6 2-1971845-6 Δ_{10} 1-1971845-6 1971845-6		
BLUE			5	1	5	5	1971954-5 Δ_{8} 2-1971895-5 Δ_{10} 1-1971895-5 1971895-5 9-1971845-5 8-1971845-5 7-1971845-5 6-1971845-5 Δ_{10} 5-1971845-5 4-1971845-5 3-1971845-5 2-1971845-5 1-1971845-5 1971845-5	
NATURAL				1	4	4	6-1971845-8 5-1971845-8 Δ_{10} 4-1971845-8 3-1971845-8 2-1971845-8 1-1971845-8 1971845-8	
NATURAL				1	3	3	3	1971946-7 1971895-7 9-1971845-7 8-1971845-7 7-1971845-7 6-1971845-7 5-1971845-7 4-1971845-7 3-1971845-7 2-1971845-7 1-1971845-7 1971845-7
NATURAL				1	2	2	2	1-1971895-6 1971895-6 9-1971845-6 8-1971845-6 7-1971845-6 6-1971845-6 5-1971845-6 4-1971845-6 3-1971845-6 2-1971845-6 Δ_{10} 1-1971845-6 1971845-6
NATURAL				1	1	1	1	1971954-5 Δ_{8} 2-1971895-5 Δ_{10} 1-1971895-5 1971895-5 9-1971845-5 8-1971845-5 7-1971845-5 6-1971845-5 Δ_{10} 5-1971845-5 4-1971845-5 3-1971845-5 2-1971845-5 1-1971845-5 1971845-5
NATURAL				1	1	1	1	1971954-5 Δ_{8} 2-1971895-5 Δ_{10} 1-1971895-5 1971895-5 9-1971845-5 8-1971845-5 7-1971845-5 6-1971845-5 Δ_{10} 5-1971845-5 4-1971845-5 3-1971845-5 2-1971845-5 1-1971845-5 1971845-5
NATURAL				1	1	1	1	1971954-5 Δ_{8} 2-1971895-5 Δ_{10} 1-1971895-5 1971895-5 9-1971845-5 8-1971845-5 7-1971845-5 6-1971845-5 Δ_{10} 5-1971845-5 4-1971845-5 3-1971845-5 2-1971845-5 1-1971845-5 1971845-5
NATURAL		1		1	1	1	1971954-5 Δ_{8} 2-1971895-5 Δ_{10} 1-1971895-5 1971895-5 9-1971845-5 8-1971845-5 7-1971845-5 6-1971845-5 Δ_{10} 5-1971845-5 4-1971845-5 3-1971845-5 2-1971845-5 1-1971845-5 1971845-5	
NATURAL	1	1		1	1	1971954-5 Δ_{8} 2-1971895-5 Δ_{10} 1-1971895-5 1971895-5 9-1971845-5 8-1971845-5 7-1971845-5 6-1971845-5 Δ_{10} 5-1971845-5 4-1971845-5 3-1971845-5 2-1971845-5 1-1971845-5 1971845-5		
NATURAL	1	1		1	1	1971954-5 Δ_{8} 2-1971895-5 Δ_{10} 1-1971895-5 1971895-5 9-1971845-5 8-1971845-5 7-1971845-5 6-1971845-5 Δ_{10} 5-1971845-5 4-1971845-5 3-1971845-5 2-1971845-5 1-1971845-5 1971845-5		

color	QTY	②	QTY	①	NO. OF POS.	TE PART NO.
GREEN	4	TAB CONTACT w/ MATT TIN PLATING (2-1971895-4 IS WITH BRIGHT TIN)	1	4	4	1971962-4 2298030-4 9-1971895-4 8-1971895-4 Δ_{8} 7-1971895-4 6-1971895-4 5-1971895-4 4-1971895-4 3-1971895-4 2-1971895-4 Δ_{10} 1-1971895-4 1971895-4 Δ_{10} 9-2304591-4 9-1971845-4 8-1971845-4 7-1971845-4 6-1971845-4 5-1971845-4 4-1971845-4 3-1971845-4 2-1971845-4 1-1971845-4 1971845-4
natural	3		1	3	3	5-1971895-3 4-1971895-3 3-1971895-3 2-1971895-3 1-1971895-3 1971895-3 9-1971845-3 8-1971845-3 7-1971845-3 6-1971845-3 5-1971845-3 4-1971845-3 3-1971845-3 2-1971845-3 1-1971845-3 1971845-3
natural	2		1	2	2	7-1971895-2 6-1971895-2 5-1971895-2 4-1971895-2 3-1971895-2 2-1971895-2 1-1971895-2 1971895-2 9-1971845-2 8-1971845-2 7-1971845-2 6-1971845-2 5-1971845-2 4-1971845-2 3-1971845-2 2-1971845-2 1-1971845-2 1971845-2
natural	1		1	1	1	7-1971895-2 6-1971895-2 5-1971895-2 4-1971895-2 3-1971895-2 2-1971895-2 1-1971895-2 1971895-2 9-1971845-2 8-1971845-2 7-1971845-2 6-1971845-2 5-1971845-2 4-1971845-2 3-1971845-2 2-1971845-2 1-1971845-2 1971845-2
natural	1		1	1	1	7-1971895-2 6-1971895-2 5-1971895-2 4-1971895-2 3-1971895-2 2-1971895-2 1-1971895-2 1971895-2 9-1971845-2 8-1971845-2 7-1971845-2 6-1971845-2 5-1971845-2 4-1971845-2 3-1971845-2 2-1971845-2 1-1971845-2 1971845-2
natural	1		1	1	1	7-1971895-2 6-1971895-2 5-1971895-2 4-1971895-2 3-1971895-2 2-1971895-2 1-1971895-2 1971895-2 9-1971845-2 8-1971845-2 7-1971845-2 6-1971845-2 5-1971845-2 4-1971845-2 3-1971845-2 2-1971845-2 1-1971845-2 1971845-2
natural	1		1	1	1	7-1971895-2 6-1971895-2 5-1971895-2 4-1971895-2 3-1971895-2 2-1971895-2 1-1971895-2 1971895-2 9-1971845-2 8-1971845-2 7-1971845-2 6-1971845-2 5-1971845-2 4-1971845-2 3-1971845-2 2-1971845-2 1-1971845-2 1971845-2
natural	1		1	1	1	7-1971895-2 6-1971895-2 5-1971895-2 4-1971895-2 3-1971895-2 2-1971895-2 1-1971895-2 1971895-2 9-1971845-2 8-1971845-2 7-1971845-2 6-1971845-2 5-1971845-2 4-1971845-2 3-1971845-2 2-1971845-2 1-1971845-2 1971845-2
natural	1		1	1	1	7-1971895-2 6-1971895-2 5-1971895-2 4-1971895-2 3-1971895-2 2-1971895-2 1-1971895-2 1971895-2 9-1971845-2 8-1971845-2 7-1971845-2 6-1971845-2 5-1971845-2 4-1971845-2 3-1971845-2 2-1971845-2 1-1971845-2 1971845-2
natural	1		1	1	1	7-1971895-2 6-1971895-2 5-1971895-2 4-1971895-2 3-1971895-2 2-1971895-2 1-1971895-2 1971895-2 9-1971845-2 8-1971845-2 7-1971845-2 6-1971845-2 5-1971845-2 4-1971845-2 3-1971845-2 2-1971845-2 1-1971845-2 1971845-2

THIS DRAWING IS A CONTROLLED DOCUMENT. OWN: HRP 21Jan2013
 CHK: HAPYE 21Jan2013
 APVD: YHM 21Jan2013

STE TE Connectivity

NAME: RAST 5 TAB HEADER ASSY
 DIN STYLE, TH, VERTICAL

SIZE: A1 CAGE CODE: 00779 DRAWING NO: 108-106080
 WEIGHT: - RESTRICTED TO: -

MATERIAL: - FINISH: - SCALE: 8:1 SHEET 2 OF 6 REV: B9

LOC	DIST	REV	DATE	BY	APPV

color	QTY	②	QTY	①	NO. OF POS.	TE PART NO.
NATURAL	8	1	1	8	8	6-1971846-8
						5-1971846-8
						4-1971846-8
						3-1971846-8
NATURAL	7	1	1	7	7	2-1971846-8
						1-1971846-8
						1971846-8
						1971896-7
						9-1971846-7
						8-1971846-7
						7-1971846-7
						6-1971846-7
						5-1971846-7
						4-1971846-7
						3-1971846-7
						2-1971846-7
NATURAL	6	1	1	6	6	1-1971846-7
						1-1971896-6
						1971896-6
						9-1971846-6
						8-1971846-6
						7-1971846-6
						6-1971846-6
						5-1971846-6
						4-1971846-6
						3-1971846-6
						2-1971846-6
						1-1971846-6
NATURAL	5	1	1	5	5	1971846-6
						1971896-5
						9-1971846-5
						8-1971846-5
						7-1971846-5
						6-1971846-5
						5-1971846-5
						4-1971846-5
						3-1971846-5
						2-1971846-5
						1-1971846-5
						1971846-5

color	QTY	②	QTY	①	NO. OF POS.	TE PART NO.
NATURAL	4	1	1	4	4	2-2298031-4
						9-2461804-4
						1-2298031-4
						9-1971896-4
NATURAL	3	1	1	3	3	7-1971896-4
						6-1971896-4
						5-1971896-4
						4-1971896-4
						3-1971896-4
						2-1971896-4
						1-1971896-4
						1971896-4
						9-1971846-4
						8-1971846-4
						7-1971846-4
						6-1971846-4
NATURAL	2	1	1	2	2	5-1971846-4
						4-1971846-4
						3-1971846-4
						2-1971846-4
						1-1971846-4
						1971846-4
						4-1971896-3
						3-1971896-3
						2-1971896-3
						1-1971896-3
						1971896-3
						9-1971846-3
8-1971846-3						
7-1971846-3						
6-1971846-3						
5-1971846-3						
4-1971846-3						
3-1971846-3						
2-1971846-3						
1-1971846-3						
1971846-3						
6-1971896-2						
5-1971896-2						
4-1971896-2						
3-1971896-2						
2-1971896-2						
1-1971896-2						
1971896-2						
9-1971846-2						
8-1971846-2						
7-1971846-2						
6-1971846-2						
5-2461804-2						
5-1971846-2						
4-1971846-2						
3-2461804-2						
3-2304599-2						
3-1971846-2						
2-1971846-2						
1-1971846-2						
2732384-2						
1971846-2						

THIS DRAWING IS A CONTROLLED DOCUMENT. DWG: HRP 21Jan2013
 CHK: HAPYE 21Jan2013
 APVD: YHM 21Jan2013

STE TE Connectivity

NAME: RAST 5 TAB HEADER ASSY
 DIN STYLE, TH, VERTICAL

PRODUCT SPEC: 108-106080
 APPLICATION SPEC: -

SIZE: A1 CAGE CODE: 00779 DRAWING NO: 1971845
 WEIGHT: -
 MATERIAL: -

Customer Drawing SCALE: 8:1 SHEET: 3 OF 6 REV: B9

LOC		DIST		REVISIONS				
P	LTN	DESCRIPTION			DATE	OWN	APVD	
		SEE SHEET 1						

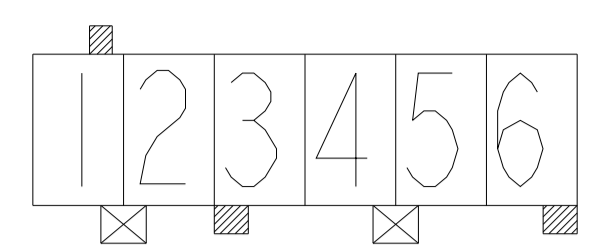

1-1971845-6
1-1971846-6

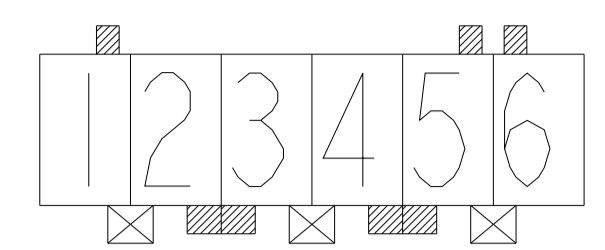

1-1971895-6
1-1971896-6

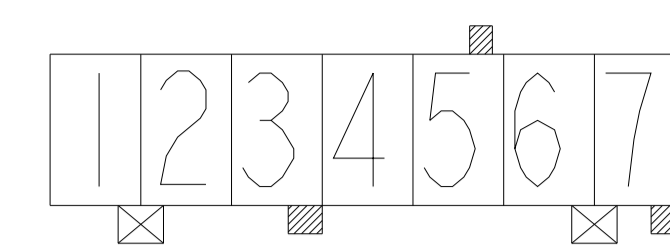

1-1971845-7
1-1971846-7

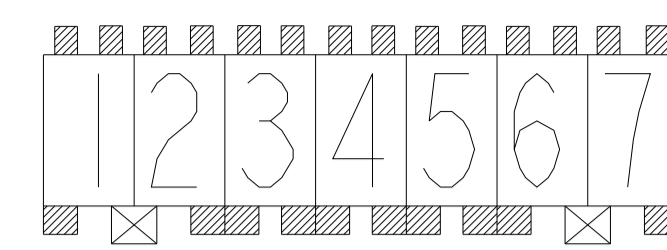

1-1971895-7
1-1971896-7

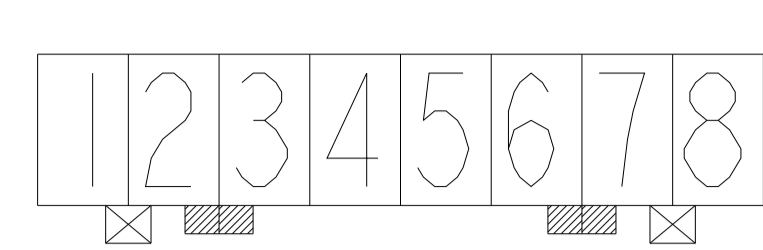

1-1971845-8
1-1971846-8

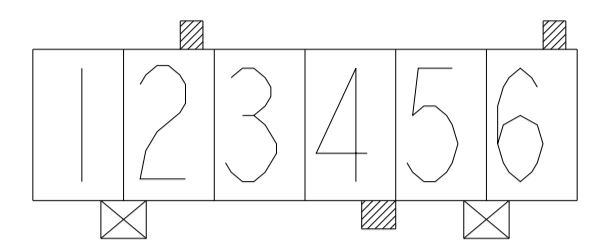

1-1971845-6
1-1971846-6

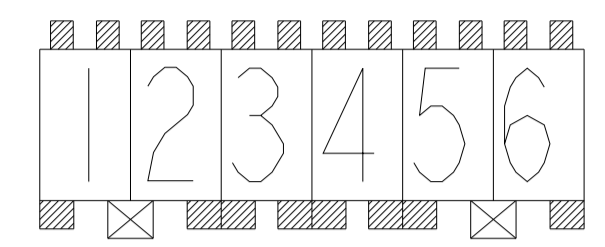

1-1971895-6
1-1971896-6

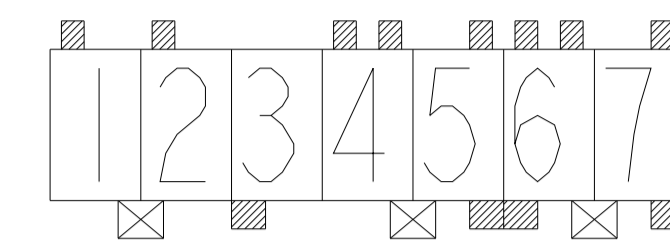

1-1971845-7
1-1971846-7

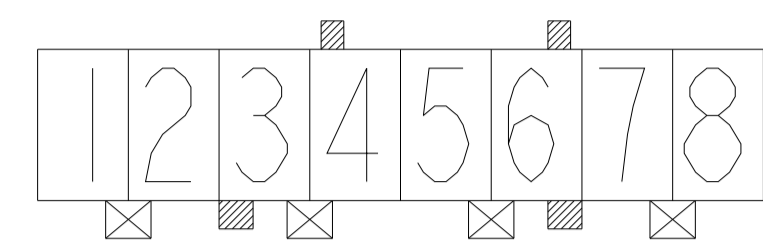

1-1971845-8
1-1971846-8

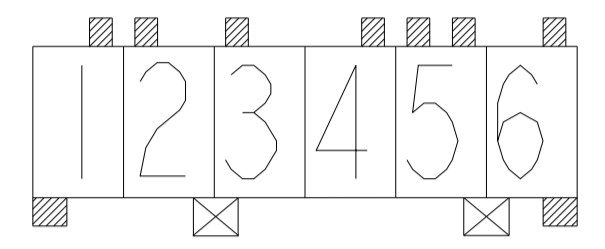

2-1971845-6
2-1971846-6

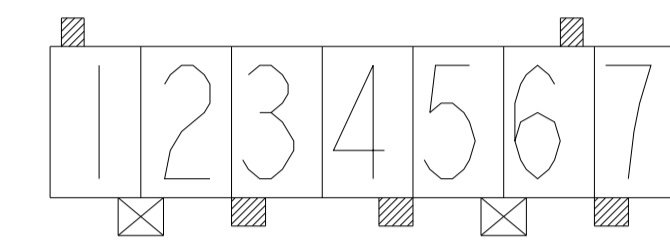

2-1971845-7
2-1971846-7

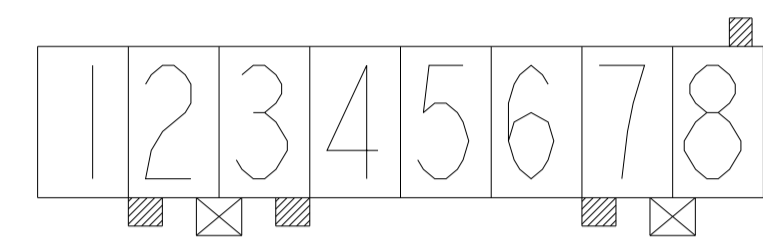

2-1971845-8
2-1971846-8

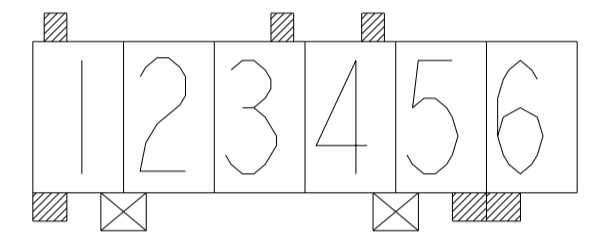

3-1971845-6
3-1971846-6

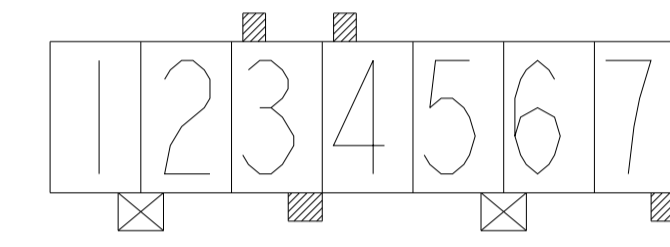

3-1971845-7
3-1971846-7

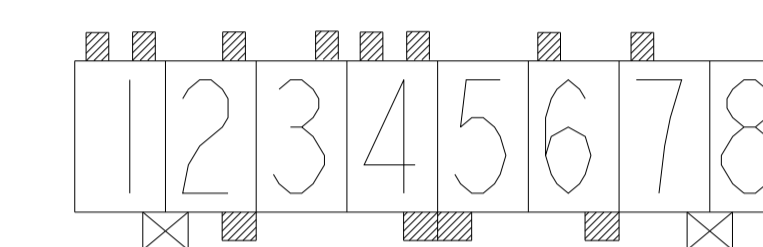

3-1971845-8
3-1971846-8

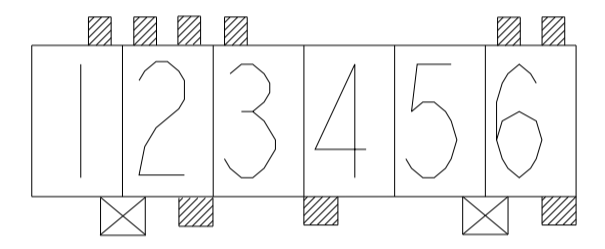

4-1971845-6
4-1971846-6

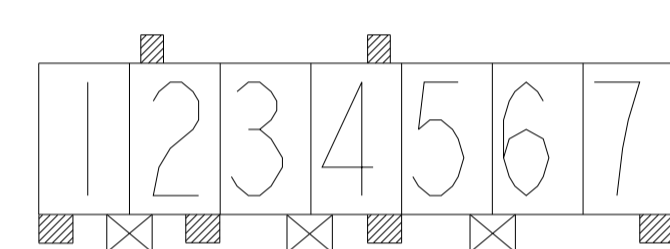

4-1971845-7
4-1971846-7

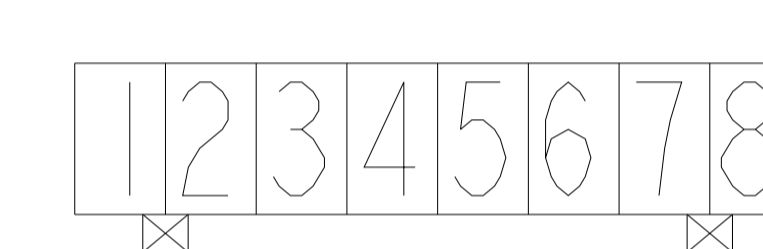

4-1971845-8
4-1971846-8

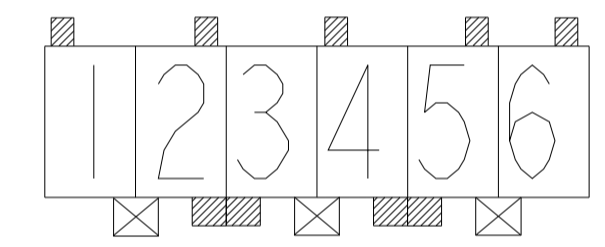

5-1971845-6
5-1971846-6

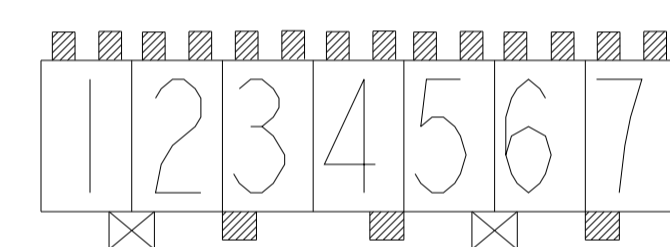

5-1971845-7
5-1971846-7

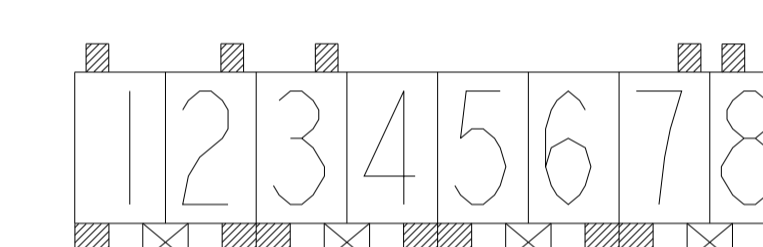

5-1971845-8
5-1971846-8

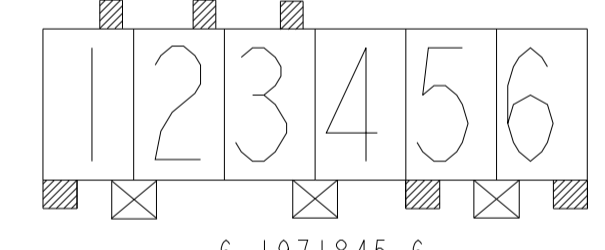

6-1971845-6
6-1971846-6

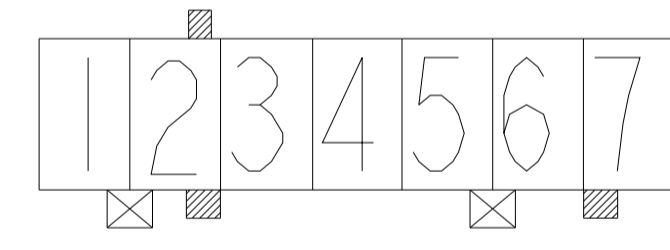

6-1971845-7
1971946-7
6-1971846-7

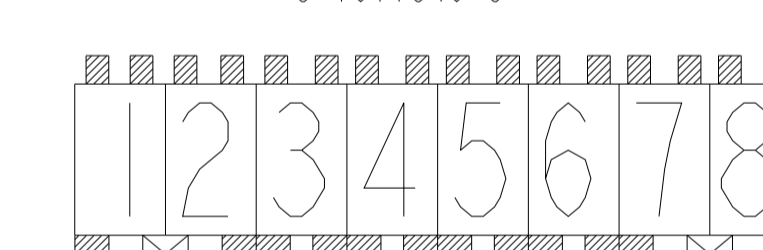

6-1971845-8
6-1971846-8

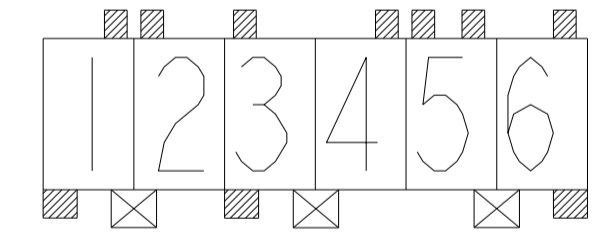

7-1971845-6
7-1971846-6

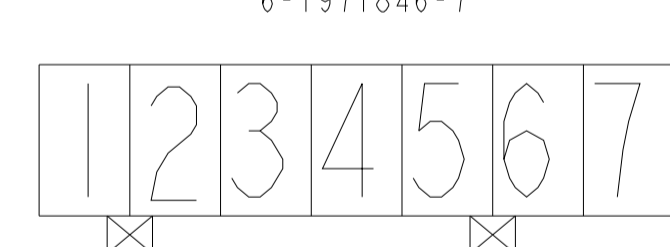

7-1971845-7
7-1971846-7

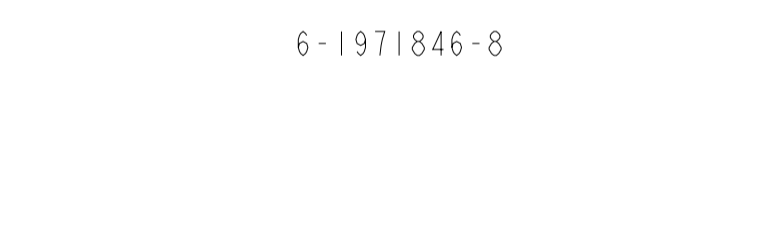

6-1971845-8
6-1971846-8

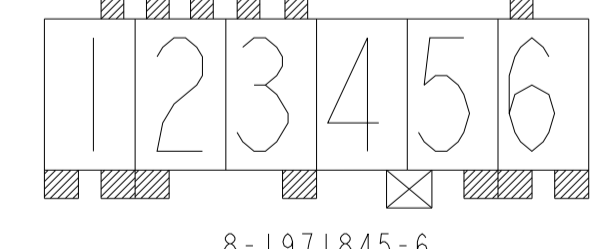

8-1971845-6
8-1971846-6

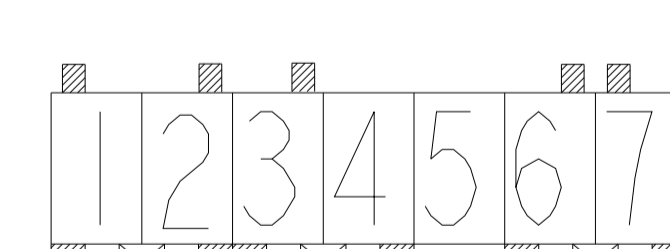

8-1971845-7
8-1971846-7



6-1971845-8
6-1971846-8

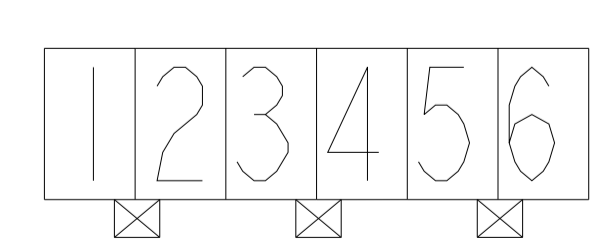

9-1971845-6
9-1971846-6

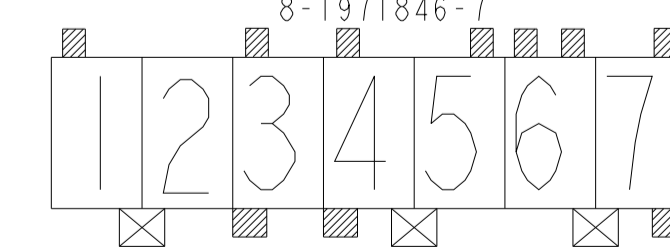

9-1971845-7
9-1971846-7

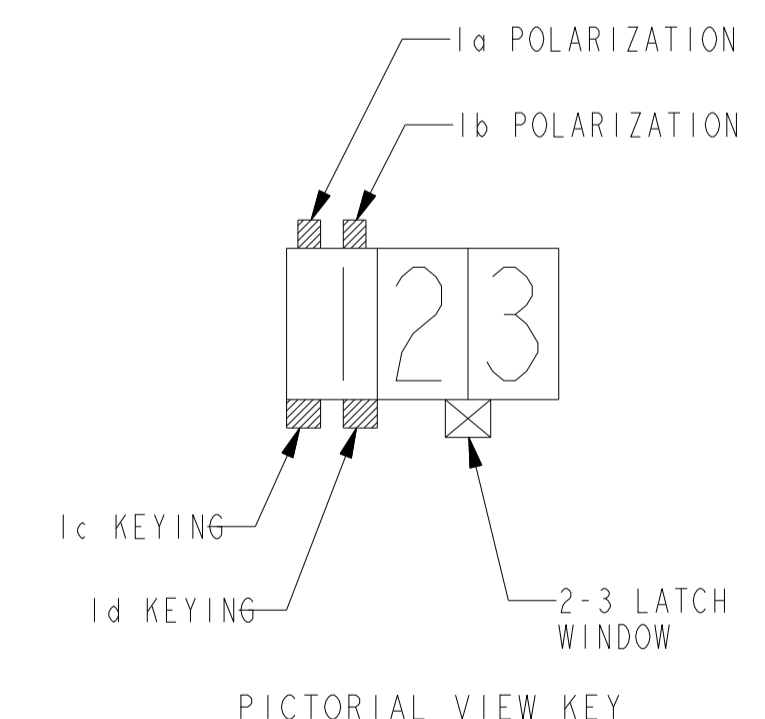

THIS DRAWING IS A CONTROLLED DOCUMENT.		OWN: WRP 21Jan2013	TE Connectivity
		CHK: HAPYE 21Jan2013	
DIMENSIONS:		APVD: YHM 21Jan2013	NAME: RAST 5 TAB HEADER ASSY DIN STYLE, TH, VERTICAL
TOLERANCES UNLESS OTHERWISE SPECIFIED: mm: 0 PLC ±, 1 PLC ±, 2 PLC ±0.25, 3 PLC ±, 4 PLC ±, ANGLES ±2° FINISH: -		PRODUCT SPEC: 108-106080 APPLICATION SPEC: -	
MATERIAL: -		WEIGHT: -	RESTRICTED TO: -
Customer Drawing		SCALE: 8:1	SHEET 5 OF 6 REV: B9

LOC		DIST		REVISIONS			
P	LTN	DESCRIPTION	DATE	OWN	APVD		
		SEE SHEET 1					

FOR ANY KEYING CONFIGURATION, THERE ARE EIGHT COLORS AVAILABLE, BESIDES THE NATURAL COLOR. THERE ARE OTHER SEVEN COLORS, INCLUDE: YELLOW, BLUE, GREY, PURPLE, RED, GREEN, BLACK. THE WHITE VERSION IS PRELIMINARY. THE P/N OF THE COLOR CONNECTOR ARE BASED ON THE NATURAL CONNECTOR. THE PREFIX AND POSTFIX ARE THE SAME FOR THE SAME KEYING CONFIGURATION, BUT THE BASE NUMBERS ARE DIFFERENT ACCORDING TO DIFFERENT COLOR. THE FOLLOWING SHOWS WHAT'S THE P/N FOR COLOR CONNECTOR

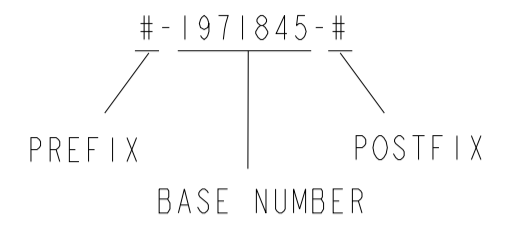

COLOR	PART NUMBER OF THE CONNECTOR					COMMENTS
	WITH MATT TIN PLATING CONTACT (SPECIAL P/N: 2-1971895-4, 2-1971845-6, 6-1971845-5, 5-1971845-8 AND 2-1971895-5 ARE WITH BRIGHT TIN)		WITH AG PLATING CONTACT			
NATURAL	#-1971845-#	#-1971895-#	#-1971846-#	#-1971896-#	#-2461804-#	THE DETAIL P/N FOR DIFFERENT KEYING SEE SHEET 2-5
RED	#-1971946-#	#-1971948-#	#-1971947-#	#-1971949-#	/	THE PREFIX AND POSTFIX ARE THE SAME WITH THE P/N OF THE NATURAL CONNECTOR FOR THE SAME KEYING, POLARIZATION, LATCH WINDOW CONFIGURATION. JUST THE BASE NUMBERS ARE DIFFERENT BASED ON DIFFERENT COLOR. # CAN BE THE NUMBER FROM 0 TO 9. BUT THERE ARE TWO EXEMPTION PART NUMBERS. 1971954-5 (BLUE) AND 1971946-7 (RED)
BLUE	#-1971954-#	#-1971956-#	#-1971955-#	#-1971957-#	/	
YELLOW	#-2232008-#	#-2232010-#	#-2232009-#	#-2232011-#	/	
BALCK	#-2232000-#	#-2232002-#	#-2232001-#	#-2232003-#	/	
GREY	#-2232016-#	#-2232018-#	#-2232017-#	#-2232019-#	/	
GREEN	#-1971962-#	#-1971964-#	#-1971963-#	#-1971965-#	/	
PURPLE	#-2232024-#	#-2232026-#	#-2232025-#	#-2232027-#	/	
WHITE	#-2232289-#	#-2232291-#	#-2232290-#	#-2232292-#	/	

THERE ARE TWO EXEMPTION FOR COLOR PART NUMBERS

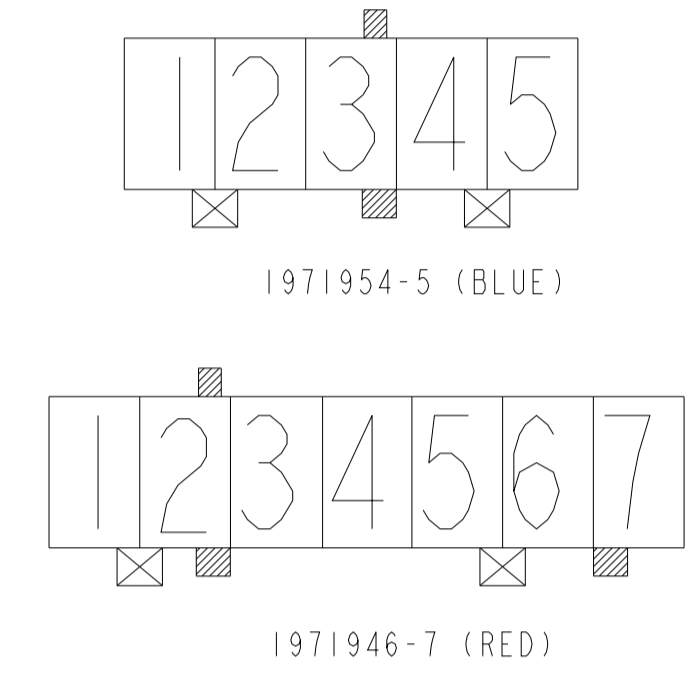

FOR EXAMPLE, IF A CONNECTOR WITH THE CONFIGURATION AS BELOW, AND WITH MATT TIN PLATING CONTACT, IN THE SHEET 4, WE CAN FIND THE RELATED CONNECTOR P/N WITH NATURAL COLOR IS 1-1971845-4, THEN WE CAN LOOK IN THE ABOVE TABLE TO FIND THE CONNECTOR P/N WITH RED COLOR IS 1-1971946-3

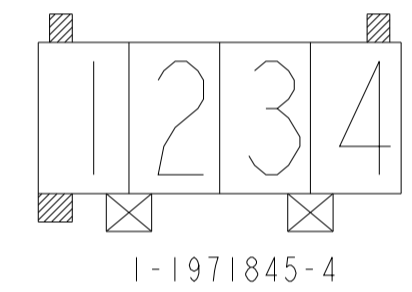

COLOR	PART NUMBER OF THE CONNECTOR		COMMENTS
	WITH BRIGHT TIN PLATING CONTACT		
NATURAL	#-2232906-#	#-2232907-#	THE KEYING, POLARIZATION AND LATCH WINDOW CONFIGURATION ARE SAME AS THE MATT TIN CONNECTOR WITH THE SAME PREFIX AND POSTFIX FOR EACH COLOR. FOR EXAMPLE: 2232906-4 AND 1971845-4 HAVE SAME KEYING, POLARIZATION AND LATCH WINDOW CONFIGURATION. 2232907-4 AND 1971895-4 HAVE SAME KEYING, POLARIZATION AND LATCH WINDOW CONFIGURATION. THE DETAIL KEYING, POLARIZATION AND LATCH WINDOW CONFIGURATION FOR EACH P/N, PLEASE SEE SHEET 2-5
RED	#-2232908-#	#-2232909-#	
BLUE	#-2232910-#	#-2232911-#	
YELLOW	#-2232912-#	#-2232913-#	
BALCK	#-2232914-#	#-2232915-#	
GREY	#-2232916-#	#-2232917-#	
GREEN	#-2232918-#	#-2232919-#	
PURPLE	#-2232920-#	#-2232921-#	
WHITE	#-2232922-#	#-2232923-#	

THIS DRAWING IS A CONTROLLED DOCUMENT.		OWN: HRP 21Jan2013	TE Connectivity
DIMENSIONS: mm		CHK: HAPYE 21Jan2013	
		APVD: YHM 21Jan2013	
TOLERANCES UNLESS OTHERWISE SPECIFIED:		NAME: RAST 5 TAB HEADER ASSY	PRODUCT SPEC: 108-106080 APPLICATION SPEC:
0 PLC ± 1 PLC ±0.25 2 PLC ± 3 PLC ± 4 PLC ± ANGLES ±2° FINISH		SIZE: A1	
MATERIAL: -		WEIGHT: -	RESTRICTED TO: -
Customer Drawing		SCALE: 8:1	SHEET: 6 OF 6