

PL71 Series

Push-on Lock Coaxial Connectors

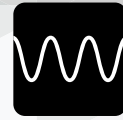

RF



75Ω

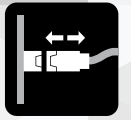

Push On



May. 1. 2026 Copyright 2026 HIROSE ELECTRIC CO., LTD. All Rights Reserved.



Features

1. 20% Smaller than Conventional 75Ω Coaxial Connectors (based on our measurements)

2. Unique Locking System with High Contact Reliability

The connection uses our unique locking system designed to keep the electrical reference surface in constant contact. (Top Touch)

The design includes an outer cylinder that protects and ensures high stability and reliability.

3. Stable, Stationary Center Contact Design

To protect the extremely thin center conductor of 75Ω series coaxial cables, all center contacts are fixed. This ensures that the cable is not damaged when the connector is inserted, removed, or subjected to rotational load.

4. Impedance Matching

The high frequency characteristics are V.S.W.R. 1.3 Max. and impedance matching from 0 to 3GHz, suitable for 3G-SDI broadcasting equipment.

Applications

The PL71 Series is ideal for use in the digital cable television broadcasting industry. This 75Ω coaxial series is compatible with BNC(75) Series and PO82M Series, enabling a wide range of functions, including interface connections, plug-in mounting, and wiring within devices.

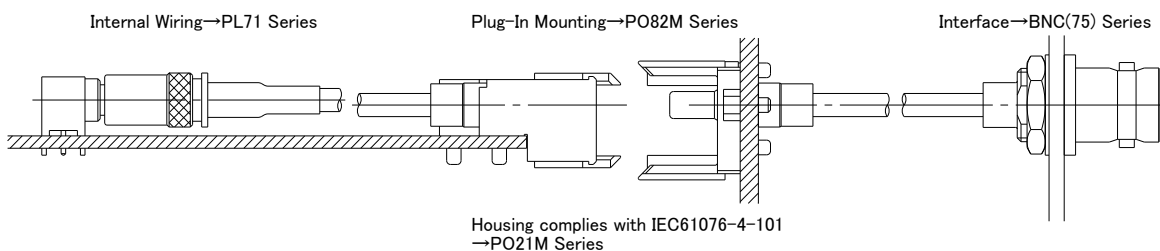

Product Specifications

Characteristic Impedance	75 Ω	Operating Temperature	-30 to +85°C
Rated Frequency	0 to 3GHz	Operating Relative Humidity	95% Max.

Item	Standards	Condition
Contact Resistance	6m Ω Max.	Measured at 100mA Max.
Insulation Resistance	1,000M Ω Min.	Measured at 500V DC
Withstanding Voltage	No dielectric breakdown	500V AC for 1 min.
V.S.W.R.	1.3 Max.	Up to 3GHz
Insertion and Withdrawal Forces	9.8N Min.	Measured with a Compatible Connector
Mating Durability	Contact Resistance : 11m Ω Max.	500 times
Vibration Resistance	No electrical discontinuity of 1 μ s or more No damage, cracks or part dislocation.	Frequency 10 to 500Hz, Half Amplitude 0.75mm, Acceleration 98m/s ² , 10 cycles in 3 directions
Shock Resistance	No electrical discontinuity of 1 μ s or more No damage, cracks or part dislocation.	Acceleration 490m/s ² , Duration 11 ms, Sine halfwave : 3 times each in 3 axial both directions
Humidity Resistance	Insulation Resistance : 100M Ω Min. (in a high humidity environment) Insulation Resistance : 1,000M Ω Min. (in a dry environment) No damage, cracks or part dislocation.	Temperature -10 to +65°C , Humidity 90 to 96%, 10 cycles (Leave for 240 hours)
Thermal Shock	No damage, cracks or part dislocation.	(-30°C : 30 min. → +5 to +35°C : 5 min. → +85°C : 30 min. → +5 to +35°C : within 5 min) 5 cycles
Corrosion Resistance	No corrosion that impairs function.	5% salt water solution for 48 consecutive hours

Note 1 : Information contained in this catalog represents general requirements for this Series.

Contact us for the drawings and specifications for a specific part number shown.

Note 2 : Ratings and standards may vary by products.

Materials / Finish

Component	Material	Finish	Remarks
Shell	Brass	Nickel Plating	-
Male Center Contact	Brass	Gold Plating	-
Female Center Contact	Beryllium Copper	Gold Plating	-
Insulator	PTFE	-	Noncombustible

Product Number Structure





Refer to the chart below when determining the product specifications from the product number.
Please select from the product numbers listed in this catalog when placing orders.

PL71 - [] - []

① ② ③

① Series Name	PL71	③ Compatible Cable or PCB Mounting Method	1.5C / 1.5CV : 1.5C-QEV·CW 1.5CW : 1.5C-QEW.CW PC : PCB DIP Mounting Type
② Connector Type	P : Straight Plug LP: Right Angle Plug R : Straight Receptacle LR: Right Angle Receptacle		

Functional Diagram

Plug	Receptacle
<p>■ Straight Plug PL71-P-###</p> 	<p>■ Straight Receptacle PL71-R-PC</p> 
<p>■ Right Angle Plug PL71-LP-###</p> 	<p>■ Right Angle Receptacle PL71-LR-PC</p> 

Plug

●Straight

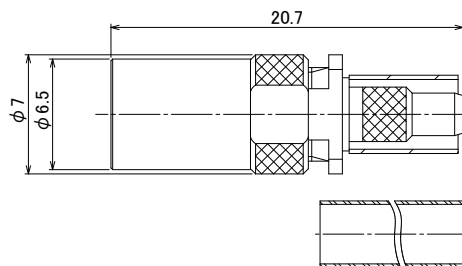

Part No.	HRS No.	Compatible Cable	Purchase Unit
PL71-P-1.5CW(40)	CL0334-0001-5-40	1.5C-QEW.CW	20pcs per bag
PL71-P-1.5CV-1(40)	CL0334-0069-9-40	1.5C-QEV.CW	

●Right Angle

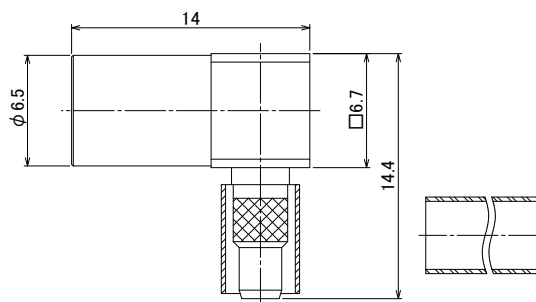

Part No.	HRS No.	Compatible Cable	Purchase Unit
PL71-LP-1.5CW(40)	CL0334-0006-9-40	1.5C-QEW.CW	20pcs per bag
PL71-LP-1.5C(40)	CL0334-0007-1-40	1.5C-QEV.CW 1.5CCA-EXBV(LF)	

Receptacle

● Straight

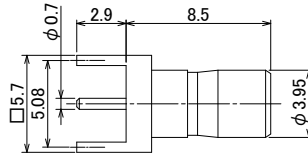

Part No.	HRS No.	Purchase Unit
PL71-R-PC(40)	CL0334-0011-9-40	10pcs per bag

■ PCB Mounting Pattern

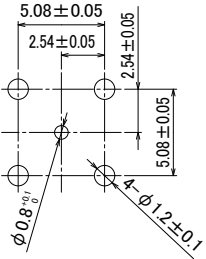

● Right Angle

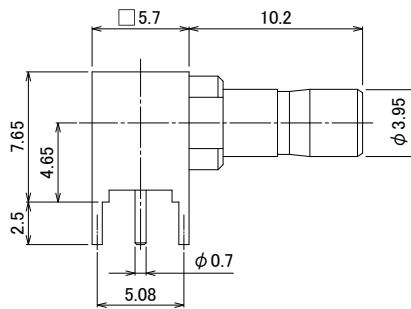

Part No.	HRS No.	Purchase Unit
PL71-LR-PC(40)	CL0334-0016-2-40	20pcs per bag

■ PCB Mounting Pattern

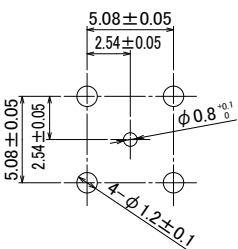

High Frequency Characteristics of 75Ω Hirose Product Series

●BNC75 Series

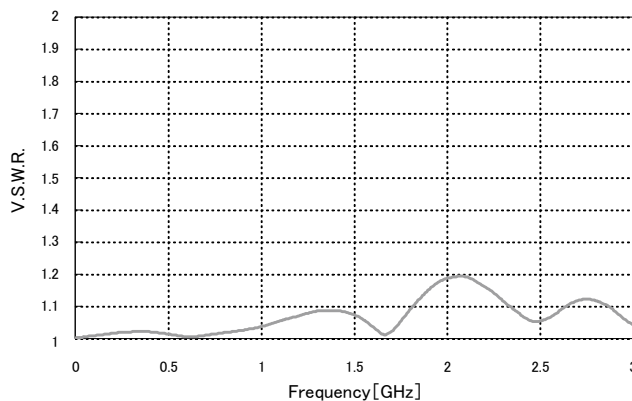
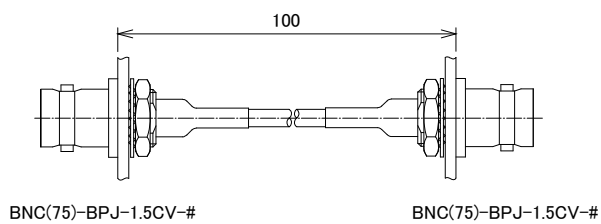

●PL71 Series

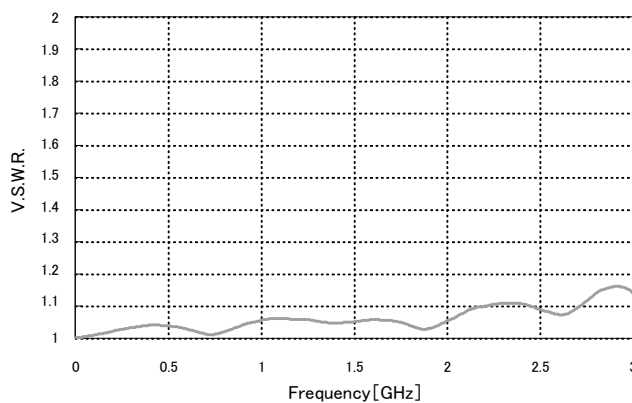
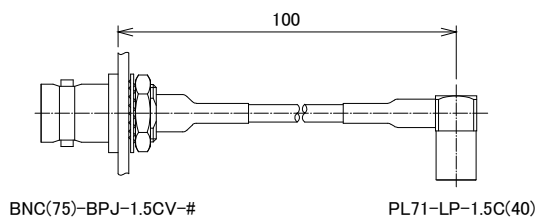

●PL75 Series

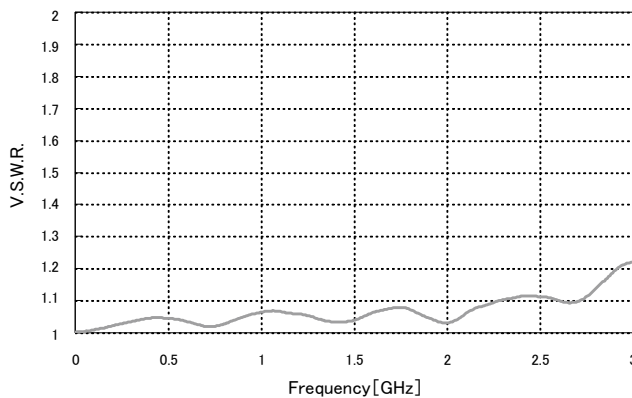
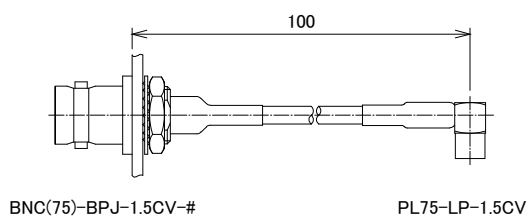

●H.FL75 Series

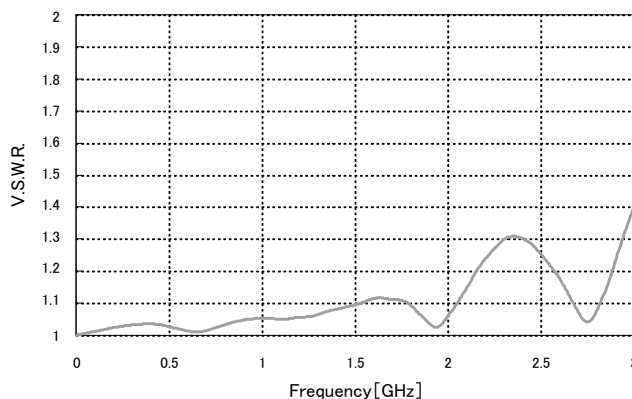
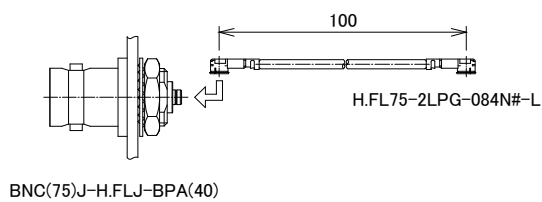

While Taking into Consideration

Specifications mentioned in this catalog are reference values.

When considering to order or use this product, please review the Drawing and Product Specifications sheets.

Use an appropriate cable when using the connector in combination with cables.

If considering usage of a non-specified cable, please contact your sales representative.

If assembly process is done by jigs & tools which are not identified by Hirose, the warranty of the product may be affected.

If considering usage for below mentioned applications, please contact your sales representative.

In cases where the application will demand a high level of reliability, such as automotive, medical instruments, public infrastructure, aerospace/defense etc. Hirose must review before assurance of reliability can be given.