

1-776261-1 ✓ ACTIVE

AMP | AMPSEAL

TE Internal #: 1-776261-1

PCB Mount Header, Vertical, Wire-to-Board, 14 Position, 4 mm [.157 in] Centerline, Fully Shrouded, Gold, Through Hole - Solder, Sealable, AMPSEAL

[View on TE.com >](#)



Connectors > PCB Connectors > PCB Headers & Receptacles > AMPSEAL PCB Vertical Headers

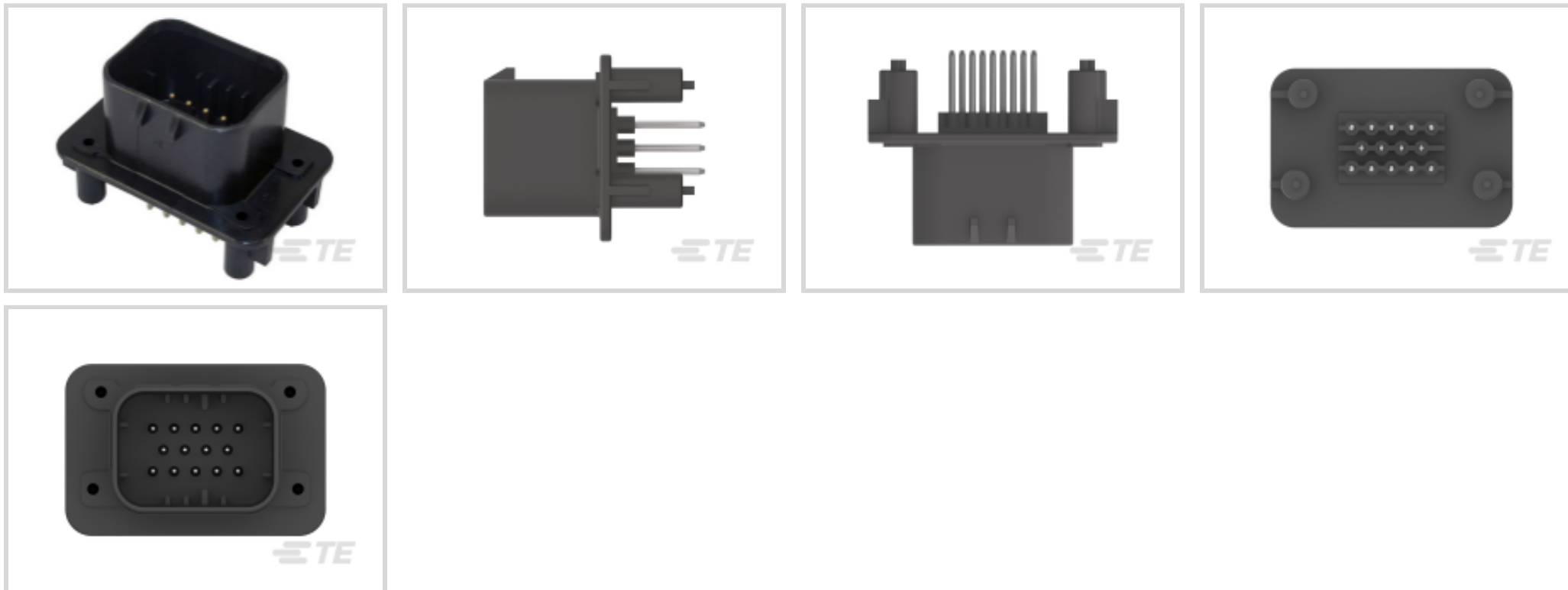

EU RoHS Compliance: **Compliant**

EU ELV Compliance: **Compliant**

PCB Connector Assembly Type: **PCB Mount Header**

PCB Mount Orientation: **Vertical**

Connector System: **Wire-to-Board**

[All AMPSEAL PCB Vertical Headers \(56\)](#)

Features

Other

EU RoHS Compliance	Compliant
EU ELV Compliance	Compliant

Product Type Features

PCB Connector Assembly Type	PCB Mount Header
Connector System	Wire-to-Board
Header Type	Fully Shrouded
Sealable	Yes
Connector & Contact Terminates To	Printed Circuit Board

Configuration Features

PCB Mount Orientation	Vertical
Number of Positions	14
Number of Rows	3



Body Features

Connector & Keying Code	1
Primary Product Color	Black

Contact Features

Contact Mating Area Plating Material	Gold
Contact Type	Pin
Contact Current Rating (Max)	17 A

Termination Features

Termination Method to PCB	Through Hole - Solder
---------------------------	-----------------------

Mechanical Attachment

PCB Mount Retention	Without
PCB Mount Alignment	With
Connector Mounting Type	Board Mount
Mating Alignment	With

Housing Features

Centerline (Pitch)	4 mm [.157 in]
--------------------	----------------

Usage Conditions

Operating Temperature Range	-40 – 125 °C [-40 – 257 °F]
-----------------------------	-----------------------------

Operation/Application

Circuit Application	Power & Signal
---------------------	----------------

Industry Standards

UL Flammability Rating	UL 94V-0
------------------------	----------

Packaging Features

Packaging Method	Tray
------------------	------

Product Compliance

[For compliance documentation, visit the product page on TE.com>](#)

EU RoHS Directive 2011/65/EU	Compliant
EU ELV Directive 2000/53/EC	Compliant
China RoHS 2 Directive MIIT Order No 32, 2016	No Restricted Materials Above Threshold
EU REACH Regulation (EC) No. 1907/2006	Current ECHA Candidate List: JUNE 2024 (241)



Candidate List Declared Against: JUNE 2024 (241)
Does not contain REACH SVHC

Halogen Content	Not Low Halogen - contains Br or Cl > 900 ppm.
Solder Process Capability	Wave solder capable to 265°C

Product Compliance Disclaimer

This information is provided based on reasonable inquiry of our suppliers and represents our current actual knowledge based on the information they provided. This information is subject to change. The part numbers that TE has identified as EU RoHS compliant have a maximum concentration of 0.1% by weight in homogenous materials for lead, hexavalent chromium, mercury, PBB, PBDE, DBP, BBP, DEHP, DIBP, and 0.01% for cadmium, or qualify for an exemption to these limits as defined in the Annexes of Directive 2011/65/EU (RoHS2). Finished electrical and electronic equipment products will be CE marked as required by Directive 2011/65/EU. Components may not be CE marked. Additionally, the part numbers that TE has identified as EU ELV compliant have a maximum concentration of 0.1% by weight in homogenous materials for lead, hexavalent chromium, and mercury, and 0.01% for cadmium, or qualify for an exemption to these limits as defined in the Annexes of Directive 2000/53/EC (ELV). Regarding the REACH Regulation, the information TE provides on SVHC in articles for this part number is based on the latest European Chemicals Agency (ECHA) 'Guidance on requirements for substances in articles' posted at this URL: <https://echa.europa.eu/guidance-documents/guidance-on-reach>

Compatible Parts



Also in the Series | AMPSEAL

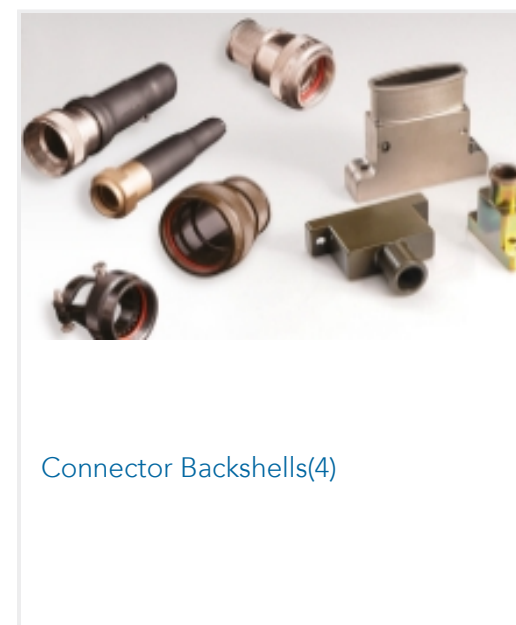
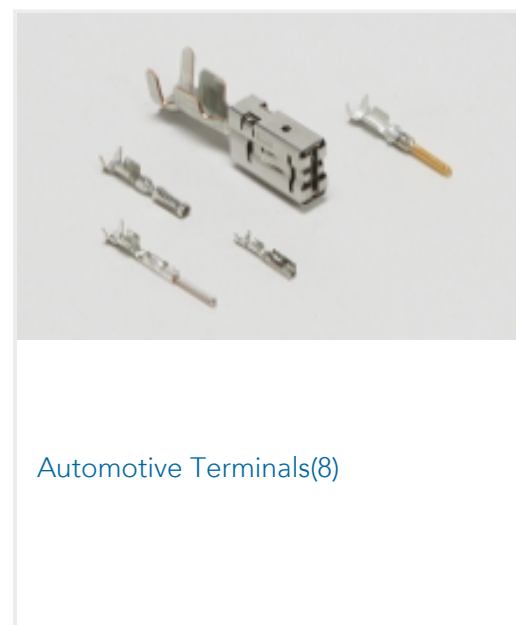
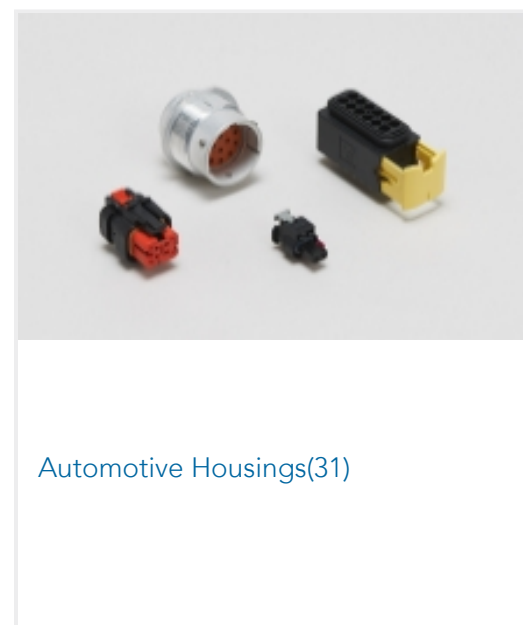
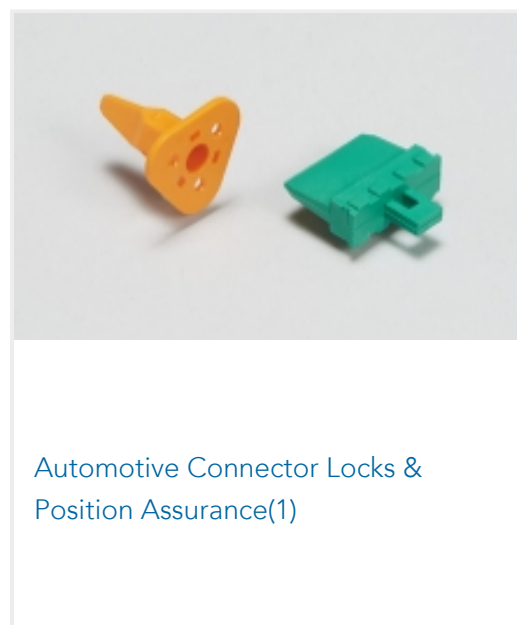

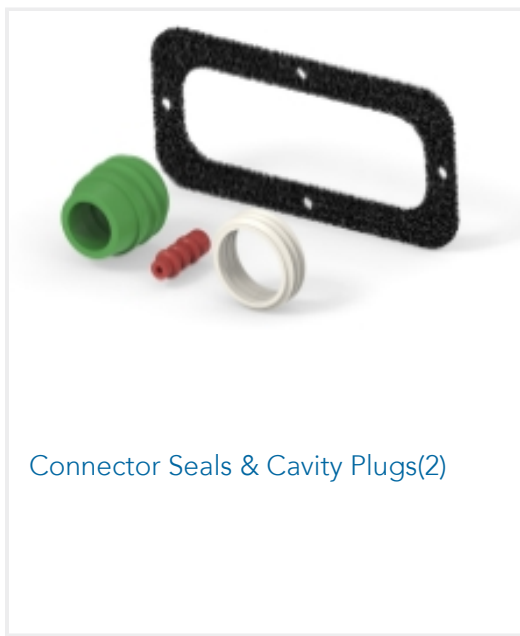

Connector Seals & Cavity Plugs(2)



PCB Headers & Receptacles(120)

Customers Also Bought

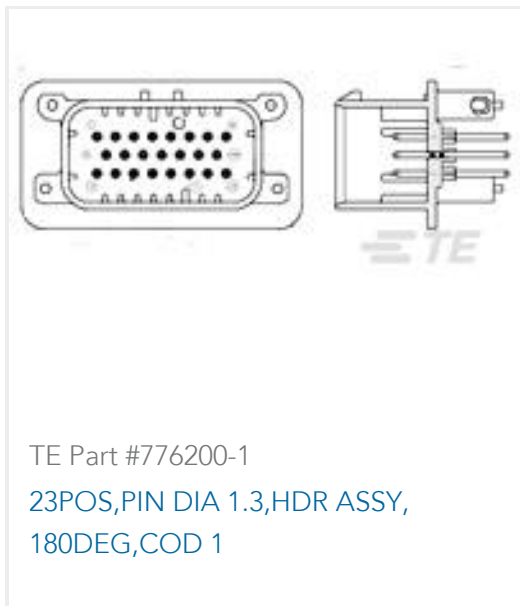

TE Part #776200-1
23POS, PIN DIA 1.3, HDR ASSY,
180DEG, COD 1



TE Part #8-338069-4
MICRO-MATCH SMD FTE



TE Part #172320-2
POSITIVE LOCK 250 (6.3 MM)
HOUSING



TE Part #1-1734795-1
RJ45, 8P8C, SHD, W/ LED, DIP 6u"



TE Part #1658607-1
50 POS HDF PLUG, MS, LEAD FREE



TE Part #2311586-4
AMPL REC, HD22, R/A, 15P,
THREADED, BLUE

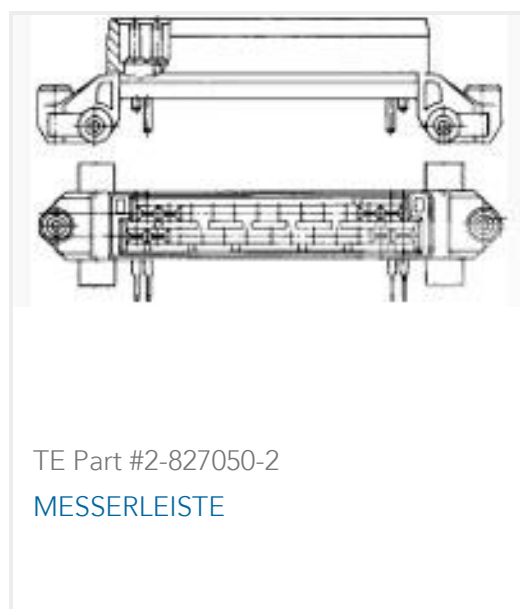

TE Part #2-827050-2
MESSERLEISTE

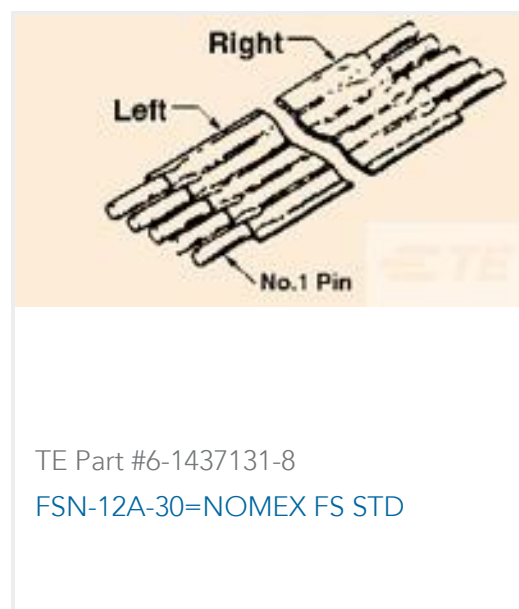

TE Part #6-1437131-8
FSN-12A-30=NOMEX FS STD

Documents

Product Drawings

14POS, PIN DIA 1.3, HDR ASSY, 180DEG, COD 1

English

CAD Files

3D PDF

English

Customer View Model

[ENG_CVM_1-776261-1_A.2d_dxf.zip](#)

English

Customer View Model

[ENG_CVM_1-776261-1_A.3d_igs.zip](#)

English

Customer View Model

[ENG_CVM_1-776261-1_A.3d_stp.zip](#)

English

By downloading the CAD file I accept and agree to the [Terms and Conditions](#) of use.



Datasheets & Catalog Pages

AMPSEAL Connector Series

English

AMPSEAL Connector Catalog

English

ICT Terminals and Connectors Catalogue

English

CONNECTOR SELECTOR

English

Product Specifications

Application Specification

English

Agency Approvals

UL Report

English