

1-66107-0 ✓ ACTIVE

AMP | AMP Type III+

TE Internal #: 1-66107-0

Pin Contact, Precious Metal, Size 16 Contact Size, 26 – 24 AWG

Wire Size, .12 – .2 mm² Wire Size, Crimp, Brass, Power & Signal,

AMP Type III+

[View on TE.com >](#)



Connectors > Contacts > Connector Contacts

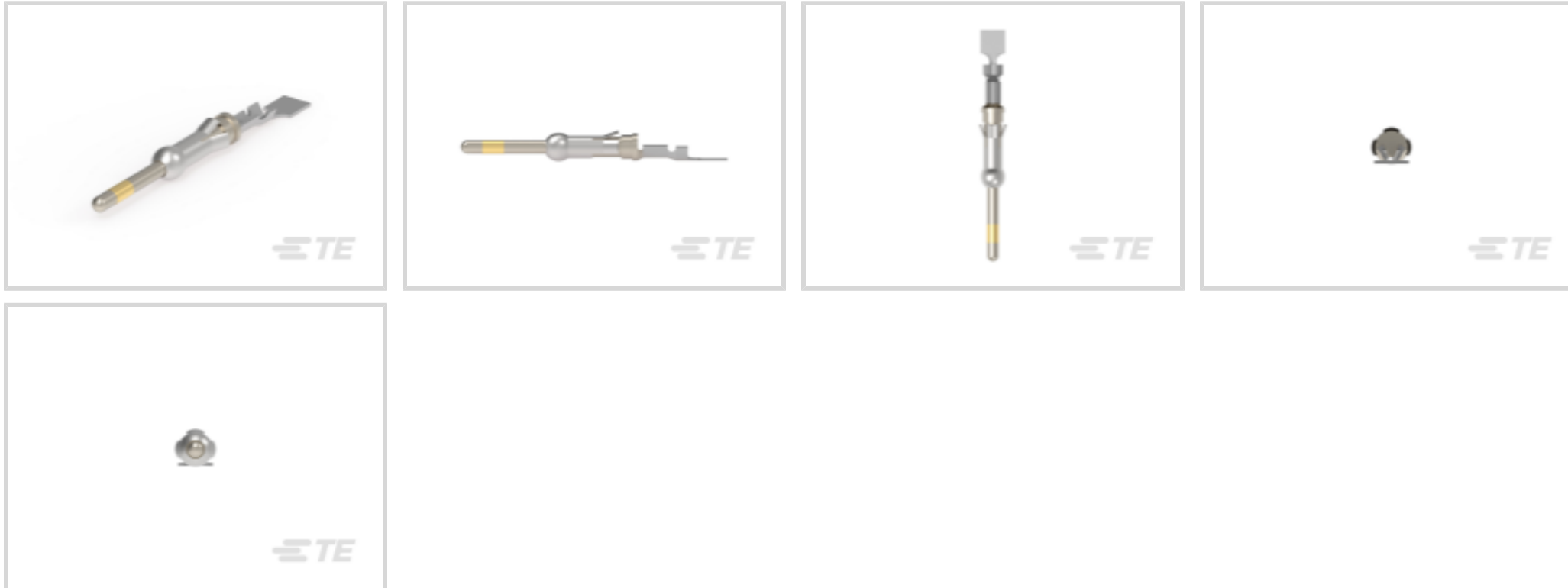

Contact Type: **Pin**

Contact Mating Area Plating Material: **Precious Metal**

Wire Contact Termination Area Plating Material: **Tin**

Contact Size: **Size 16**

Wire Size: **26 – 24 AWG**

Features

Industry Standards

Compatible With Agency/Standards Products	UL, CSA
---	---------

Mechanical Attachment

Wire Insulation Support	With
-------------------------	------

Packaging Features

Packaging Quantity	100
Packaging Method	Box, Loose Piece

Dimensions

Compatible Insulation Diameter Range	.89 – 1.4 mm [.035 – .055 in]
Wire Size	.12 – .2 mm ²

Contact Features

Contact Underplating Material	Nickel
Contact Orientation	Straight
Mating Pin Diameter	1.57 mm [.062 in]



Contact Underplating Material Thickness	1.27 µm[50 µin]
Contact Mating Area Plating Material Thickness	.76 µm[30 µin]
Wire Contact Termination Area Plating Material Finish	Bright
Wire Contact Termination Area Plating Thickness	1.27 µm[50 µin]
Contact Type	Pin
Contact Mating Area Plating Material	Precious Metal
Wire Contact Termination Area Plating Material	Tin
Contact Size	Size 16
Contact Base Material	Brass
Contact Current Rating (Max)	13 A

Termination Features

Termination Method to Wire & Cable	Crimp
Product Terminates To	Wire & Cable

Usage Conditions

Operating Temperature Range	-55 – 90 °C[-67 – 194 °F]
-----------------------------	---------------------------

Operation/Application

Circuit Application	Power & Signal
---------------------	----------------

Other

EU RoHS Compliance	Compliant
EU ELV Compliance	Compliant

Product Compliance

[For compliance documentation, visit the product page on TE.com>](#)

EU RoHS Directive 2011/65/EU	Compliant
EU ELV Directive 2000/53/EC	Compliant
China RoHS 2 Directive MIIT Order No 32, 2016	No Restricted Materials Above Threshold
EU REACH Regulation (EC) No. 1907/2006	Current ECHA Candidate List: JUNE 2024 (241) Candidate List Declared Against: JUNE 2024 (241) Does not contain REACH SVHC
Halogen Content	Low Halogen - Br, Cl, F, I < 900 ppm per homogenous material. Also BFR/CFR/PVC Free
Solder Process Capability	Not applicable for solder process capability

Product Compliance Disclaimer

This information is provided based on reasonable inquiry of our suppliers and represents our current actual knowledge based on the information they provided. This information is subject to change. The part numbers that TE has identified as EU RoHS compliant have a maximum concentration of 0.1% by weight in homogenous materials for lead, hexavalent chromium, mercury, PBB, PBDE, DBP, BBP, DEHP, DIBP, and 0.01% for cadmium, or qualify for an exemption to these limits as defined in the Annexes of Directive 2011/65/EU (RoHS2). Finished electrical and electronic equipment products will be CE marked as required by Directive 2011/65/EU. Components may not be CE marked. Additionally, the part numbers that TE has identified as EU ELV compliant have a maximum concentration of 0.1% by weight in homogenous materials for lead, hexavalent chromium, and mercury, and 0.01% for cadmium, or qualify for an exemption to these limits as defined in the Annexes of Directive 2000/53/EC (ELV). Regarding the REACH Regulation, the information TE provides on SVHC in articles for this part number is based on the latest European Chemicals Agency (ECHA) 'Guidance on requirements for substances in articles' posted at this URL: <https://echa.europa.eu/guidance-documents/guidance-on-reach>

Compatible Parts

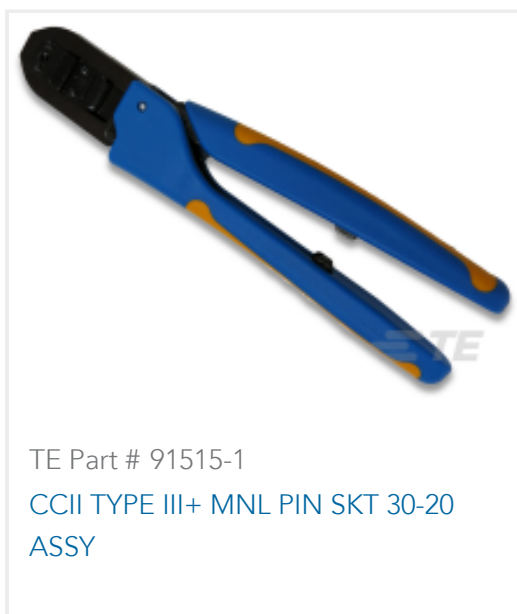

Also in the Series | AMP Type III+

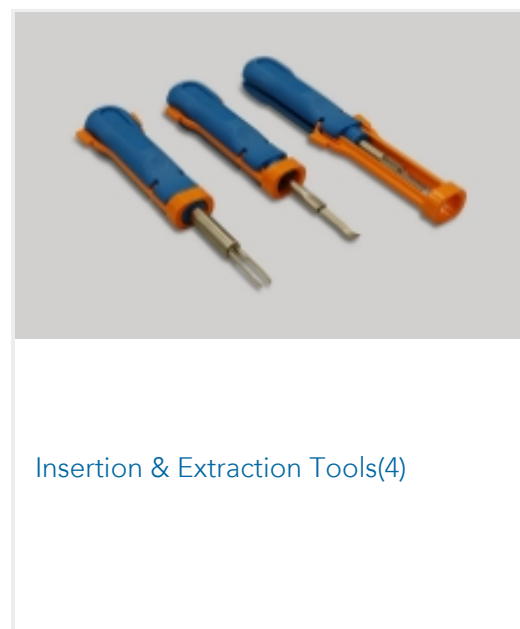
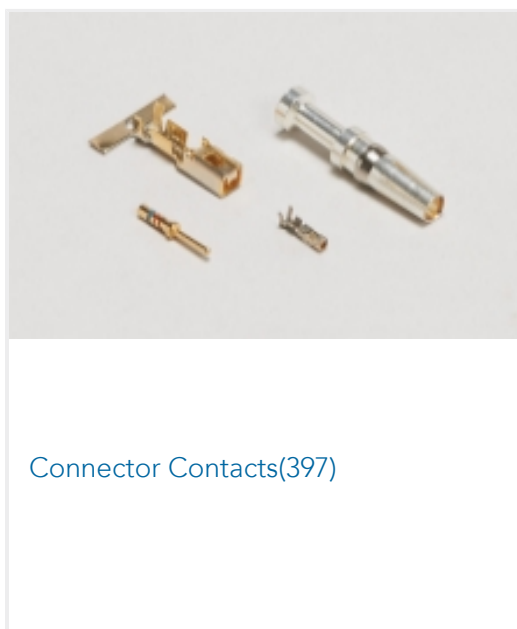

Customers Also Bought



TE Part #640923-1
RECEPT,PIDG FASTON 22-18 110



TE Part #206433-2
CPC RECPT ASSEMBLY SIZE 11-8



TE Part #1-87499-7
10 MODIV HSG SR MRKD .100CL

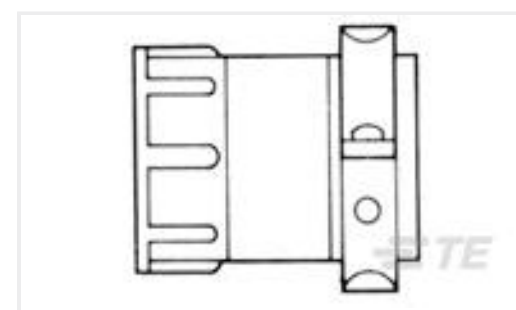

TE Part #206358-5
CABLE CLAMP ASY, SIZE 11



TE Part #66103-3
III+ PIN,24-20,15AU/FL,LP



TE Part #3-1393250-7
W28-XQ1A-4=W28-

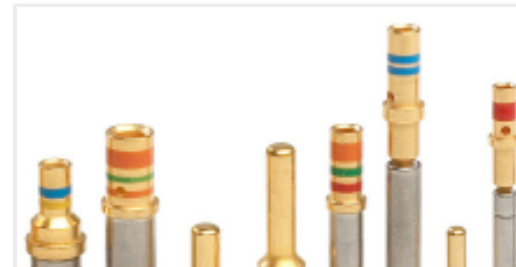

TE Part #4160-203-1631L
CONT PIN

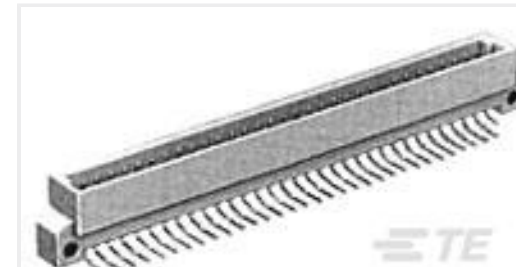

TE Part #5148103-1
ASSY,PIN,EUROCARD,TYPE B,LEAD-

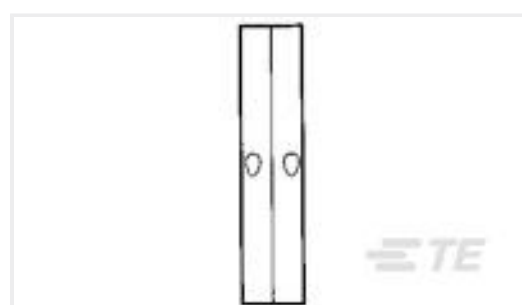

TE Part #34321
SPLICE,SOLIS BUTT 8

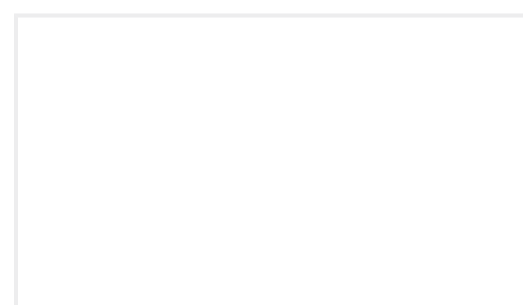

TE Part #YCTL-20C0150000000
JUNCTION ASSY

Documents

Product Drawings

III+ PIN,26-24,30AU/FL,SMPACK

English

CAD Files

Customer View Model

[ENG_CVM_CVM_1-66107-0_AC.2d_dxf.zip](#)

English

3D PDF

3D

Customer View Model

[ENG_CVM_CVM_1-66107-0_AC.3d_igs.zip](#)

English

Customer View Model

[ENG_CVM_CVM_1-66107-0_AC.3d_stp.zip](#)

English

By downloading the CAD file I accept and agree to the [Terms and Conditions](#) of use.

Product Specifications



Application Specification

English

Instruction Sheets

[Instruction Sheet \(U.S.\)](#)

Japanese

[Instruction Sheet \(U.S.\)](#)

English