

52042-1 ✓ ACTIVE

PLASTI-GRIP

TE Internal #: 52042-1

Closed Ring Tongue Terminal, 6 AWG, 1/4 / M6 Stud Size, 6.73 mm [.265 in] Stud Diameter, Closed Barrel, Straight, Tin, PLASTI-GRIP

[View on TE.com >](#)



Terminals & Splices > Ring Terminals

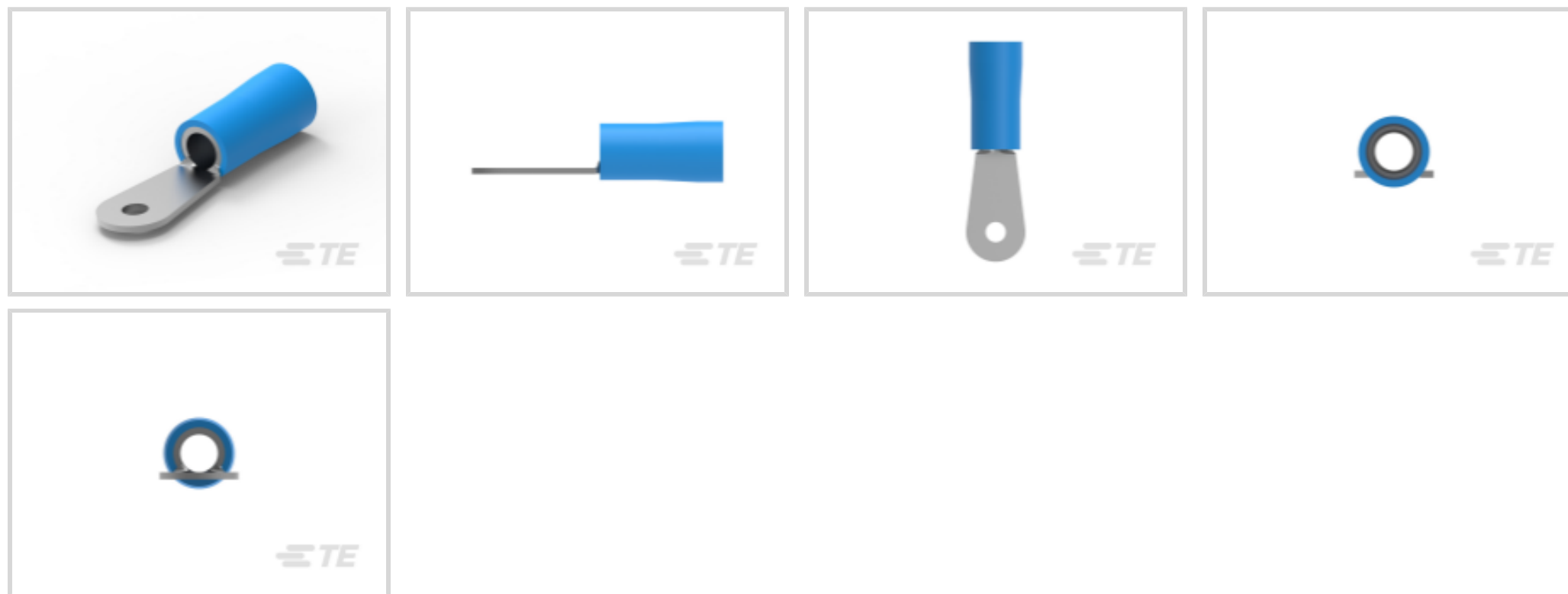

Ring Terminal Product Type: Closed Ring Tongue Terminal

Wire Size: 20800 – 33100 CMA

Stud Size: 1/4, M6

### Features

#### Product Type Features

Ring Terminal Product Type	Closed Ring Tongue Terminal
Stud Size	1/4, M6
Sealable	No
Wire Insulation Support Retention Type	Insulation Support

#### Dimensions

Wire Size	20800 – 33100 CMA
Stud Diameter	6.73 mm [.265 in]
Tongue Thickness	.79 mm [.031 in]
Product Length	46.84 mm [1.844 in]
Compatible Insulation Diameter (Max)	11.07 mm [.436 in]
Compatible Insulation Diameter Range	11.07 mm [.436 in]

#### Contact Features

Barrel Type	Closed
Terminal Orientation	Straight
Terminal Plating Material	Tin

#### Usage Conditions



Insulation Option	Partially Insulated
-------------------	---------------------

Operating Temperature Range	105 °C[221 °F]
-----------------------------	----------------

### Operation/Application

Compatible With Wire Base Material	Copper
------------------------------------	--------

Compatible With Wire Plating Material	Tin
---------------------------------------	-----

### Packaging Features

Packaging Method	Loose Piece
------------------	-------------

Packaging Quantity	100
--------------------	-----

### Other

EU RoHS Compliance	Compliant
--------------------	-----------

EU ELV Compliance	Compliant
-------------------	-----------

### Configuration Features

Number of Holes	1
-----------------	---

### Electrical Characteristics

Voltage Rating	600 V
----------------	-------

### Body Features

Insulation Sleeve Color	Blue
-------------------------	------

Stripe Color	Blue
--------------	------

### Mechanical Attachment

Wire Insulation Support	With
-------------------------	------

### Industry Standards

Government Qualified Terminal	No
-------------------------------	----

## Product Compliance

[For compliance documentation, visit the product page on TE.com>](#)

EU RoHS Directive 2011/65/EU	Compliant
------------------------------	-----------

EU ELV Directive 2000/53/EC	Compliant
-----------------------------	-----------

China RoHS 2 Directive MIIT Order No 32, 2016	No Restricted Materials Above Threshold
---	---

EU REACH Regulation (EC) No. 1907/2006	Current ECHA Candidate List: JUNE 2024 (241) Candidate List Declared Against: JUNE 2024 (241) Does not contain REACH SVHC
--	---



Halogen Content	Not Low Halogen - contains Br or Cl > 900 ppm.
-----------------	--

Solder Process Capability	Not applicable for solder process capability
---------------------------	--

**Product Compliance Disclaimer**

This information is provided based on reasonable inquiry of our suppliers and represents our current actual knowledge based on the information they provided. This information is subject to change. The part numbers that TE has identified as EU RoHS compliant have a maximum concentration of 0.1% by weight in homogenous materials for lead, hexavalent chromium, mercury, PBB, PBDE, DBP, BBP, DEHP, DIBP, and 0.01% for cadmium, or qualify for an exemption to these limits as defined in the Annexes of Directive 2011/65/EU (RoHS2). Finished electrical and electronic equipment products will be CE marked as required by Directive 2011/65/EU. Components may not be CE marked. Additionally, the part numbers that TE has identified as EU ELV compliant have a maximum concentration of 0.1% by weight in homogenous materials for lead, hexavalent chromium, and mercury, and 0.01% for cadmium, or qualify for an exemption to these limits as defined in the Annexes of Directive 2000/53/EC (ELV). Regarding the REACH Regulation, the information TE provides on SVHC in articles for this part number is based on the latest European Chemicals Agency (ECHA) 'Guidance on requirements for substances in articles' posted at this URL: <https://echa.europa.eu/guidance-documents/guidance-on-reach>

## Compatible Parts



TE Part # 52042  
TERMINAL,R PG 6 8

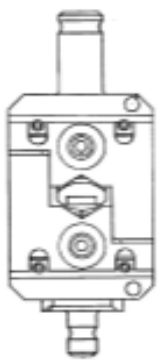

TE Part # 48753-1  
HYP8 PLASTI-GRIP 6AWG 69051 DIE SET



TE Part # 47821  
HYP8 TERMINYL 6AWG DIE SET



TE Part # 1490535-1  
HYP10 PLASTI-GRIP 6AWG DIE SET



TE Part # 1490598-1  
HYP10 TERMINYL 6AWG DIE SET



TE Part # 601129-2  
HAND TOOL (A.S.I.)

## Also in the Series | PLASTI-GRIP



Compression Connectors(3)



Crimp Wire Pins, Tabs & Ferrules(18)



Ring Terminals(297)

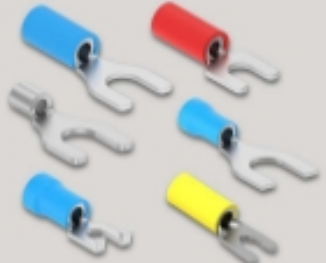

Spade Terminals(157)



Splices(44)

## Customers Also Bought

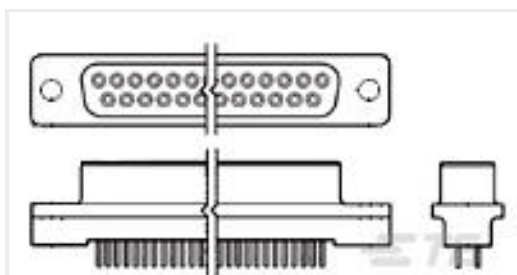

TE Part #5745080-4  
HD-20 RCPT 50P VERT FFSCRLK



TE Part #770262-3  
06P UMNL SOK HDR ASSY 94VO LF

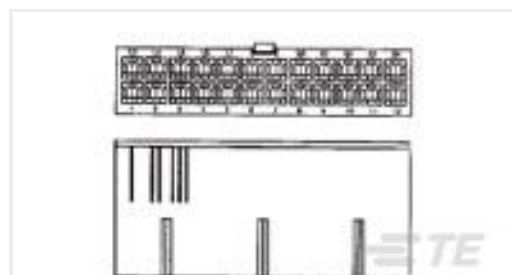

TE Part #1586017-2  
2P FH PLUG VAL-U-LOK V0



TE Part #3-1618239-2  
K41B234=RELAY, VACUUM, SPST-NC



TE Part #3-1393118-9  
KUP-14D55-36=KU



TE Part #2-1579008-3  
EXTRACTION TOOL

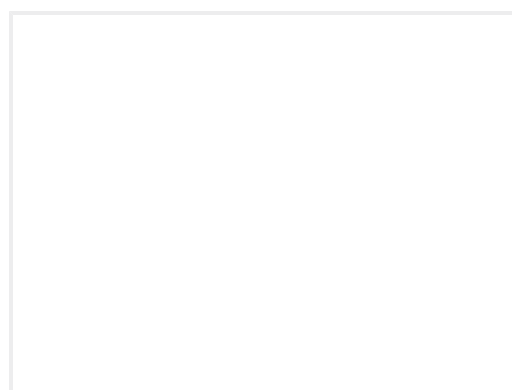

TE Part #2337127-1  
RAYMOND 1298664/001

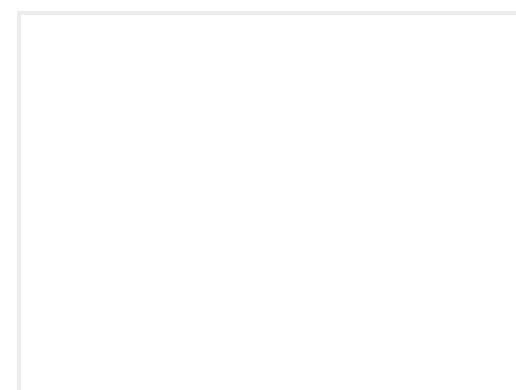

TE Part #2340984-1  
RAYMOND 1301631-001

## Documents

### Product Drawings

[TERMINAL,R PG 6 1/4](#)

English

### CAD Files

[3D PDF](#)

3D

Customer View Model

[ENG\\_CVM\\_CVM\\_52042-1\\_AD.2d\\_dxf.zip](#)

English

Customer View Model

[ENG\\_CVM\\_CVM\\_52042-1\\_AD.3d\\_igs.zip](#)

English

Customer View Model

[ENG\\_CVM\\_CVM\\_52042-1\\_AD.3d\\_stp.zip](#)

English

By downloading the CAD file I accept and agree to the [Terms and Conditions](#) of use.



---

**Product Specifications**

**Application Specification**

English

---

**Instruction Sheets**

**Instruction Sheet (U.S.)**

English

---

**Agency Approvals**

**UL Report**

English

**UL Report**

English