

1241406-1 ✓ ACTIVE

AMP MCP | AMP MCP 6.3/4.8K

TE Internal #: 1241406-1

Receptacle, Mating Tab Width 4.8 mm / 5.8 mm / 6.3 mm [.189 in / .228 in / .248 in], AMP MCP 6.3/4.8K, Automotive Terminals

[View on TE.com >](#)



Terminals & Splices > Automotive Terminals > AMP MCP, RECEPTACLE AND TAB

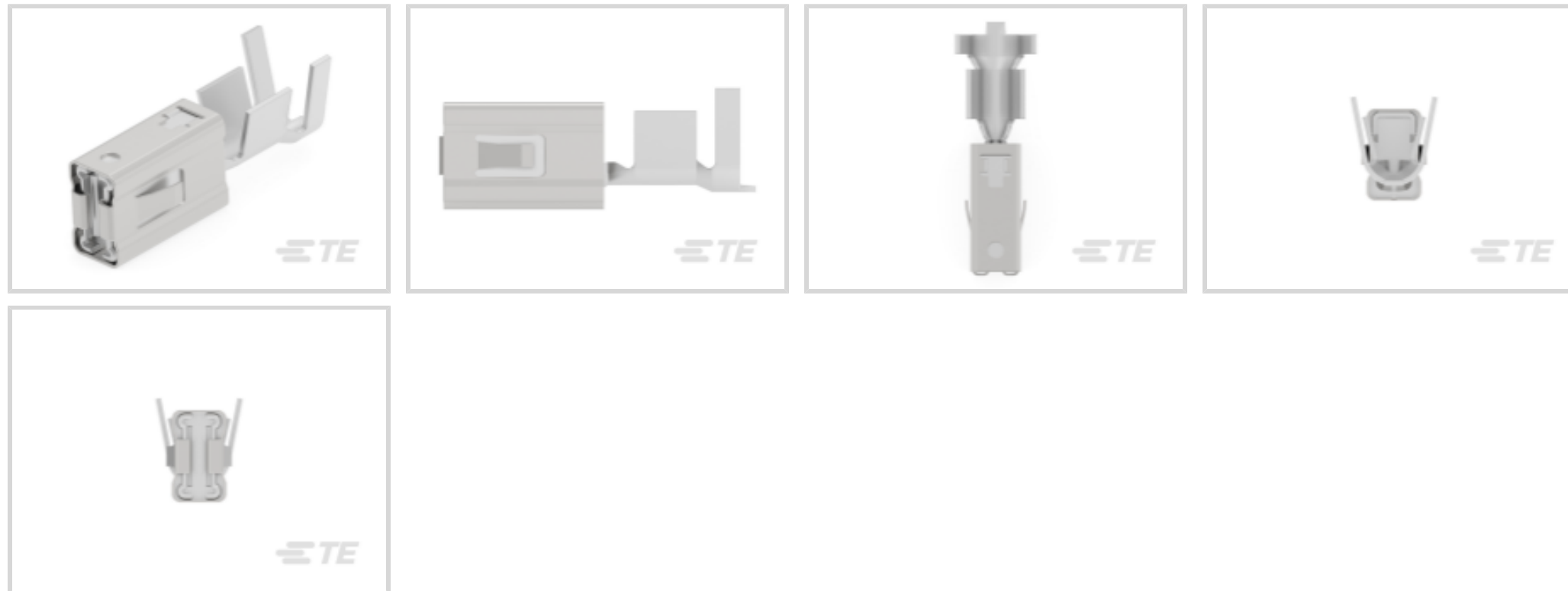

Terminal Type: **Receptacle**

Mating Tab Width: 6.3 mm, 4.8 mm, 5.8 mm [.189 in, .228 in, .248 in]

Mating Tab Thickness: .8 mm [.031 in]

Terminal Transmits: 25 – 40 A (Power)

Wire Size: 13 – 11 AWG

[All AMP MCP, RECEPTACLE AND TAB \(109\)](#)

Features

Industry Standards

Compatible With Agency/Standards Products	LV214
---	-------

Operation/Application

Compatible With Wire Base Material	Copper
Conforms to Automation Guideline	Yes, KOMAX Automatic Component Insertion per Version 5.0 (March 2018)

Packaging Features

Packaging Method	Reel
Packaging Quantity	2000

Usage Conditions

Insulation Option	Uninsulated
Operating Temperature (Max)	130 °C, 125 °C, 80 °C, 105 °C, 90 °C, 100 °C, 85 °C, 110 °C, 120 °C[248 °F][221 °F][230 °F][176 °F][194 °F][185 °F][266 °F][212 °F][257 °F]

Operating Temperature Range	-40 – 130 °C[-40 – 266 °F]
-----------------------------	----------------------------

Termination Features

Termination Method to Wire & Cable	Crimp
Product Terminates To	Wire

Product Type Features

Receptacle Style	180°
Sealable	No
Primary Locking Feature	Locking Lance

Dimensions

Compatible Insulation Diameter Range	3.4 – 4.4 mm[.132 – .172 in]
Wire Size	2.5 – 4 mm ²
Wire Size Search	2.5 mm ² , 3 mm ² , 4 mm ²

Contact Features

Typical Current Rating	30 A
Crimp Type	F-Crimp
Contact Size	4.8mm, 6.3mm
Contact Fabrication	Stamped & Formed
Wire Contact Termination Area Plating Material	Tin
Terminal Type	Receptacle
Mating Tab Width	6.3 mm, 4.8 mm, 5.8 mm[.189 in][.228 in][.248 in]
Mating Tab Thickness	.8 mm[.031 in]
Interface Plating	Tin (Sn)

Other

Terminal Transmits	25 – 40 A (Power)
EU RoHS Compliance	Compliant
EU ELV Compliance	Compliant

Product Compliance

[For compliance documentation, visit the product page on TE.com>](#)

EU RoHS Directive 2011/65/EU	Compliant
EU ELV Directive 2000/53/EC	Compliant
China RoHS 2 Directive MIIT Order No 32, 2016	No Restricted Materials Above Threshold



EU REACH Regulation (EC) No. 1907/2006

Current ECHA Candidate List: JUNE 2024 (241)

Candidate List Declared Against: JUNE 2024 (241)

Does not contain REACH SVHC

Halogen Content

Low Halogen - Br, Cl, F, I < 900 ppm per homogenous material. Also BFR/CFR/PVC Free

Solder Process Capability

Not applicable for solder process capability

Product Compliance Disclaimer

This information is provided based on reasonable inquiry of our suppliers and represents our current actual knowledge based on the information they provided. This information is subject to change. The part numbers that TE has identified as EU RoHS compliant have a maximum concentration of 0.1% by weight in homogenous materials for lead, hexavalent chromium, mercury, PBB, PBDE, DBP, BBP, DEHP, DIBP, and 0.01% for cadmium, or qualify for an exemption to these limits as defined in the Annexes of Directive 2011/65/EU (RoHS2). Finished electrical and electronic equipment products will be CE marked as required by Directive 2011/65/EU. Components may not be CE marked. Additionally, the part numbers that TE has identified as EU ELV compliant have a maximum concentration of 0.1% by weight in homogenous materials for lead, hexavalent chromium, and mercury, and 0.01% for cadmium, or qualify for an exemption to these limits as defined in the Annexes of Directive 2000/53/EC (ELV). Regarding the REACH Regulation, the information TE provides on SVHC in articles for this part number is based on the latest European Chemicals Agency (ECHA) 'Guidance on requirements for substances in articles' posted at this URL: <https://echa.europa.eu/guidance-documents/guidance-on-reach>

Compatible Parts



TE Part # 1719043-1
SINGLE WIRE SEAL, GREEN



TE Part # CAT-L489-CH8172
LEAVYSEAL Connector Housings



TE Part # CAT-M8793-CH8172
MQS, CONNECTOR HOUSING



TE Part # CAT-M9194-CH8172
MULTILOCK, CONNECTOR HOUSING



TE Part # 2109193-1
025/060/250 HYB LIF 41P PLUG A



TE Part # 1-1579007-3
EXTRACTION TOOL



TE Part # 1534404-2
MCP6.3 RECEP HSG4P



TE Part # 1534404-1
MCP6.3 RECEP HSG4P



Also in the Series | **AMP MCP 6.3/4.8K**

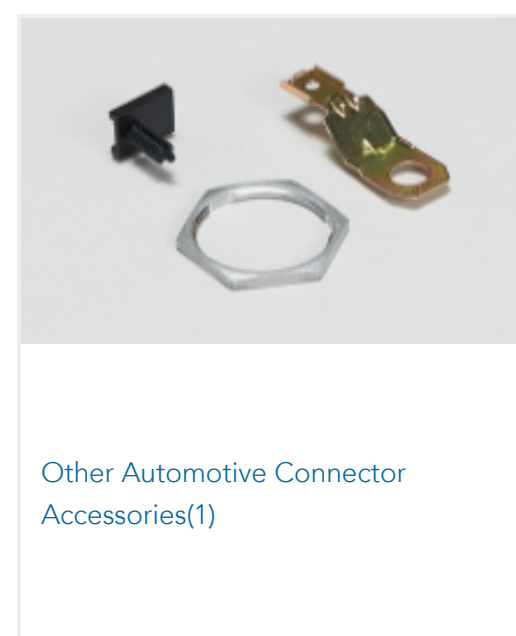
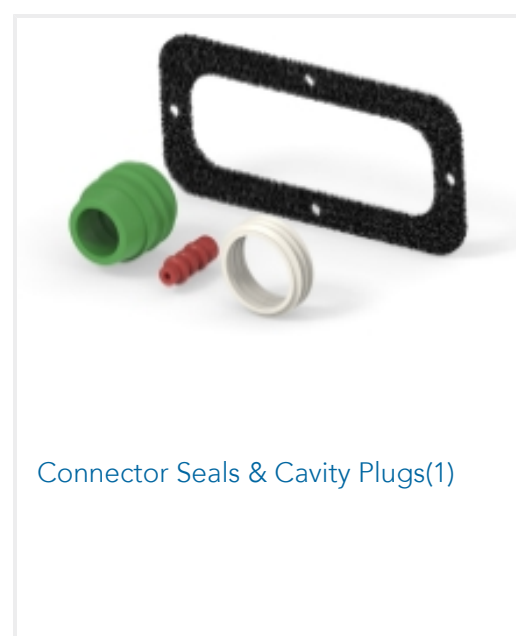
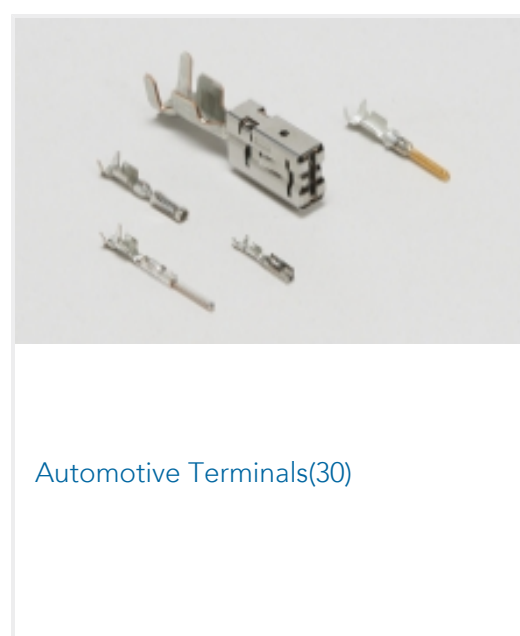
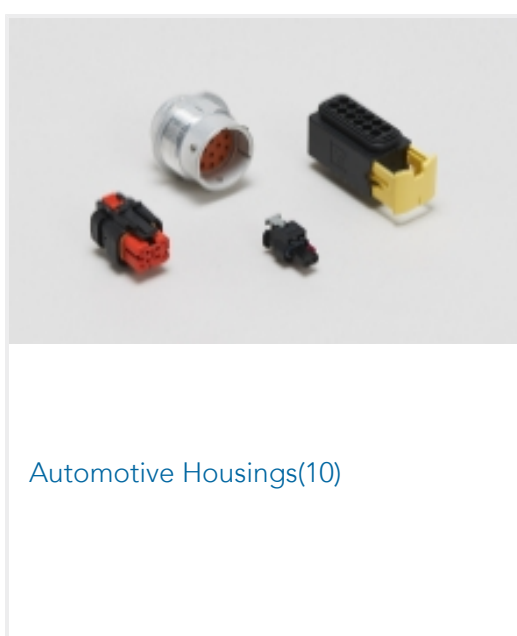

Customers Also Bought

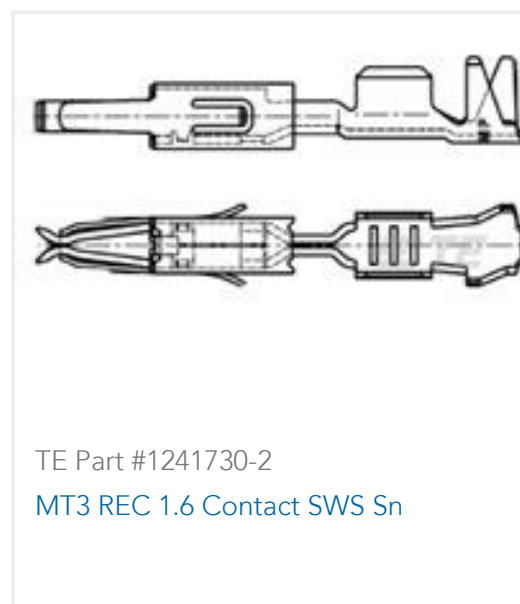

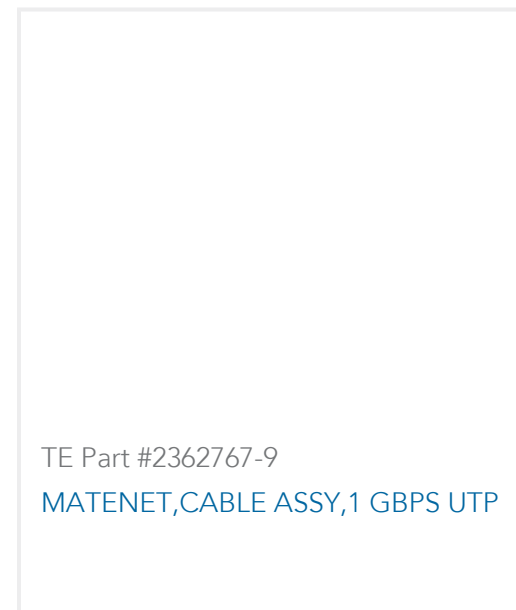

Documents

Product Drawings

AMP MCP 6.3/4.8K, CONTACT

English

CAD Files

3D PDF

3D

Customer View Model

[ENG_CVM_CVM_1241406-1_A.2d_dxf.zip](#)

English

Customer View Model

[ENG_CVM_CVM_1241406-1_A.3d_igs.zip](#)

English

Customer View Model

[ENG_CVM_CVM_1241406-1_A.3d_stp.zip](#)

English

By downloading the CAD file I accept and agree to the [Terms and Conditions](#) of use.

Product Specifications

Application Specification

German

Application Specification

English