

1544218-1 ✓ ACTIVE

AMP | NG1, NG Power Terminals and Connectors

TE Internal #: 1544218-1

Tab, Mating Tab Width 6.35 mm [.25 in], Tab Thickness .8 mm [.031 in], 13 – 9 AWG Wire Size, NG Power Terminals and Connectors, Automotive Terminals

[View on TE.com >](#)



Terminals & Splices > Automotive Terminals

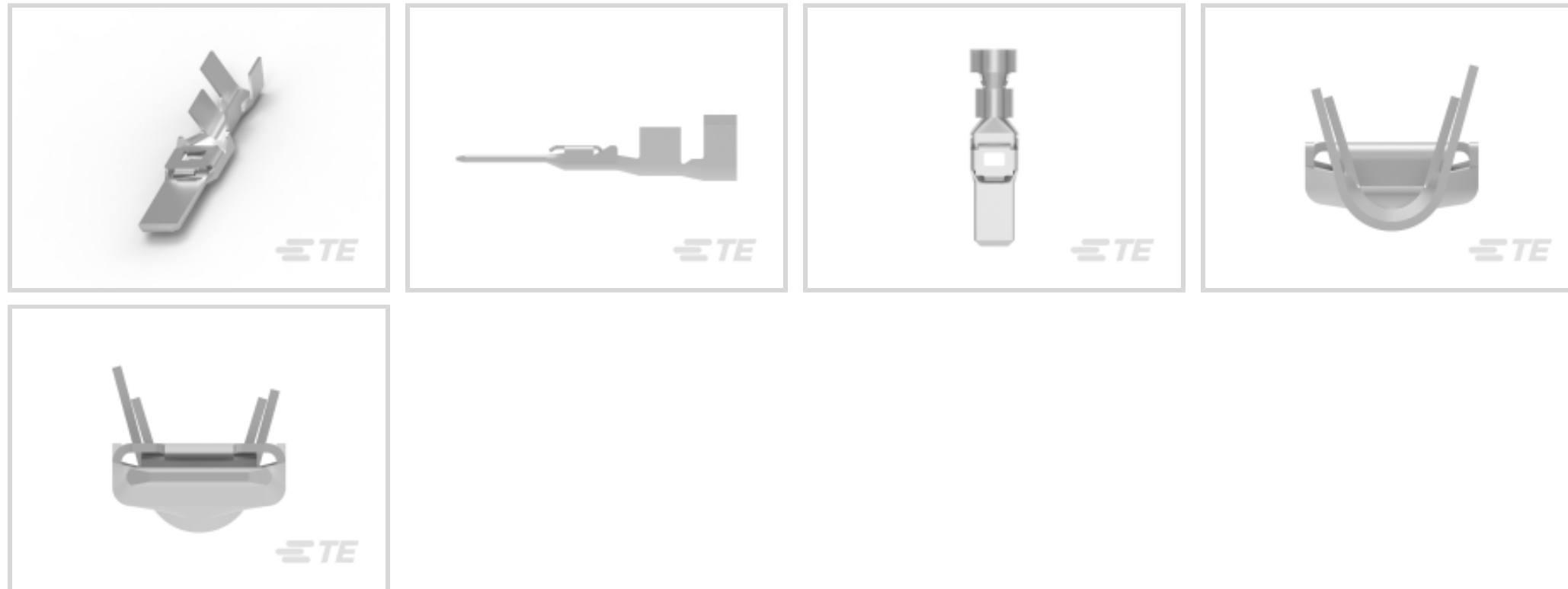

Terminal Type: **Tab**

Mating Tab Width: **6.35 mm [.25 in]**

Mating Tab Thickness: **.8 mm [.031 in]**

Terminal Transmits: **41 – 100 A (High Power)**

Wire Size: **13 – 9 AWG**

Features

Packaging Features

Packaging Method	Reel
Packaging Quantity	1700

Usage Conditions

Insulation Option	Uninsulated
Operating Temperature (Max)	125 °C, 80 °C, 105 °C, 100 °C, 90 °C, 85 °C, 110 °C, 120 °C [248 °F][221 °F][230 °F][176 °F] [194 °F][185 °F][212 °F][257 °F]
Operating Temperature Range	-40 – 125 °C [-40 – 257 °F]

Termination Features

Termination Method to Wire & Cable	Crimp
Product Terminates To	Wire

Dimensions

Compatible Insulation Diameter Range	2.8 – 4.2 mm
Wire Size	2.5 – 6 mm ²



Wire Size Search	2.5 mm ² , 3 mm ² , 4 mm ² , 5 mm ² , 6 mm ²
------------------	---

Contact Features

Typical Current Rating	46 A
Crimp Type	F-Crimp
Contact Size	6.3mm
Contact Fabrication	Stamped & Formed
Terminal Type	Tab
Mating Tab Width	6.35 mm [.25 in]
Mating Tab Thickness	.8 mm [.031 in]
Interface Plating	Tin (Sn)

Product Type Features

Sealable	No
Primary Locking Feature	Clean Body

Other

Terminal Transmits	41 – 100 A (High Power)
EU RoHS Compliance	Compliant
EU ELV Compliance	Compliant

Product Compliance

[For compliance documentation, visit the product page on TE.com>](#)

EU RoHS Directive 2011/65/EU	Compliant
EU ELV Directive 2000/53/EC	Compliant
China RoHS 2 Directive MIIT Order No 32, 2016	No Restricted Materials Above Threshold
EU REACH Regulation (EC) No. 1907/2006	Current ECHA Candidate List: JUNE 2024 (241) Candidate List Declared Against: JUNE 2024 (241) Does not contain REACH SVHC
Halogen Content	Low Halogen - Br, Cl, F, I < 900 ppm per homogenous material. Also BFR/CFR/PVC Free
Solder Process Capability	Not applicable for solder process capability

Product Compliance Disclaimer

This information is provided based on reasonable inquiry of our suppliers and represents our current actual knowledge based on the information they provided. This information is subject to change. The part numbers that TE has identified as



EU RoHS compliant have a maximum concentration of 0.1% by weight in homogenous materials for lead, hexavalent chromium, mercury, PBB, PBDE, DBP, BBP, DEHP, DIBP, and 0.01% for cadmium, or qualify for an exemption to these limits as defined in the Annexes of Directive 2011/65/EU (RoHS2). Finished electrical and electronic equipment products will be CE marked as required by Directive 2011/65/EU. Components may not be CE marked. Additionally, the part numbers that TE has identified as EU ELV compliant have a maximum concentration of 0.1% by weight in homogenous materials for lead, hexavalent chromium, and mercury, and 0.01% for cadmium, or qualify for an exemption to these limits as defined in the Annexes of Directive 2000/53/EC (ELV). Regarding the REACH Regulation, the information TE provides on SVHC in articles for this part number is based on the latest European Chemicals Agency (ECHA) 'Guidance on requirements for substances in articles' posted at this URL: <https://echa.europa.eu/guidance-documents/guidance-on-reach>

Compatible Parts



TE Part # 1544226-1
PL 3V 6,35 MM NG1

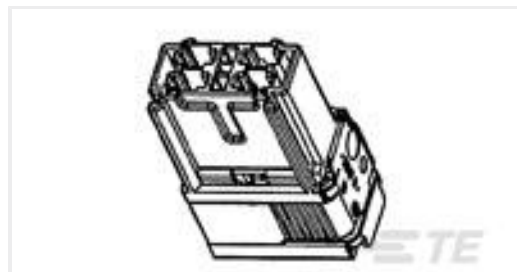

TE Part # 1544148-1
PORTE LANGUETTE ET

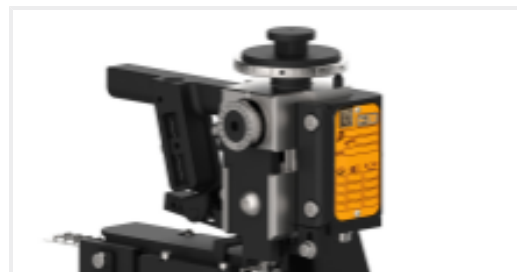

TE Part # 2266158-1
OCEAN_2.0_Applicator-S-140F185OV-RSM



TE Part # 2266158-2
OCEAN_2.0_Applicator-S-140F185OV-RSA



TE Part # 2305570-1
Strip Terminal Cutter-Side Feed-No Crimp



TE Part # 7-1579018-0
EXTRACTION TOOL



TE Part # 7-2266158-7
OCEAN_2.0_SPARE_PART_KIT-140F185OV



TE Part # 1544226-2
PL 3V 6,35 MM NG1



TE Part # 1544226-3
PL 3V 6,35 MM NG1

Also in the Series | NG1



Automotive Connector Caps & Covers
(1)



Automotive Housings(33)



Automotive Terminals(26)



Connector Seals & Cavity Plugs(10)



Insertion & Extraction Tools(12)

Also in the Series | **NG Power Terminals and Connectors**

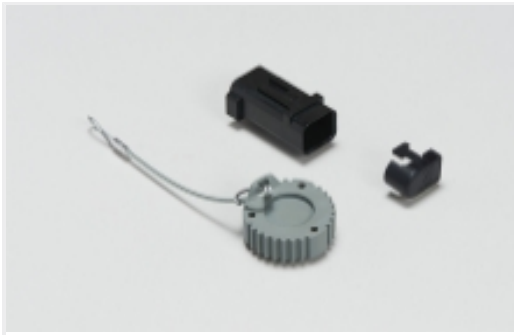

Automotive Connector Caps & Covers (1)

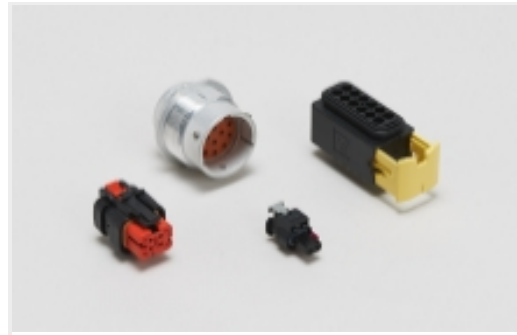

Automotive Housings(48)

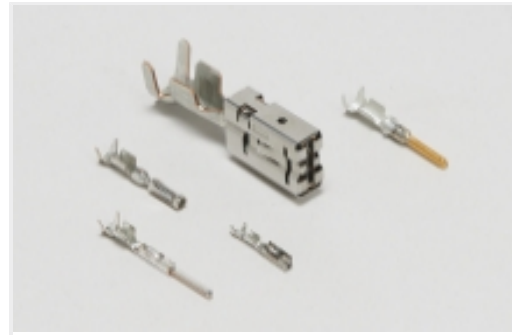

Automotive Terminals(25)



Connector Seals & Cavity Plugs(9)

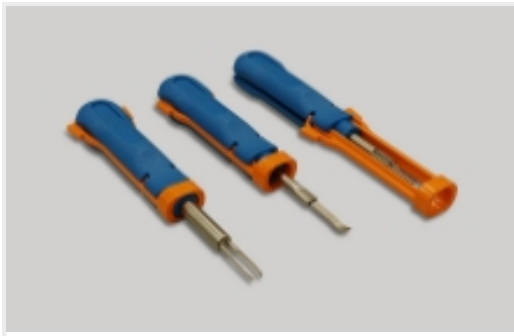

Insertion & Extraction Tools(13)



Other Automotive Connector Accessories(1)

Customers Also Bought

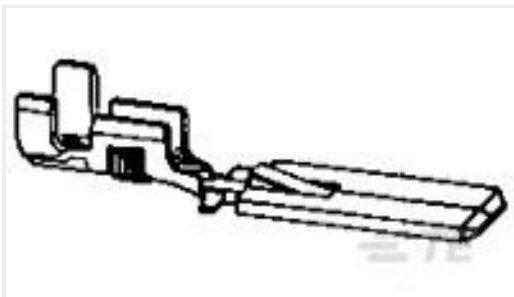

TE Part #280075-2
FF 375 TAB 3-6MM2 PTBR



TE Part #1379914-1
20POS MQS REC

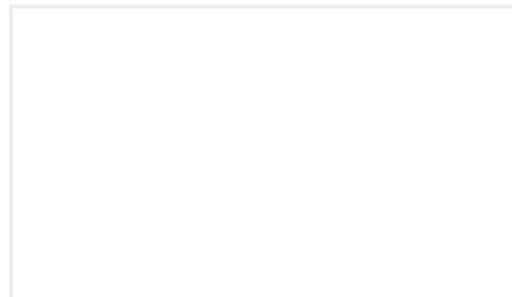

TE Part #1544346-1
BOITIER PC 8 MM 1



TE Part #1801422-1
RECEPT HOUSING ASSY, 8MM, 2 W



TE Part #926525-1
PL 250 REC HSG 3P NYLON BLACK

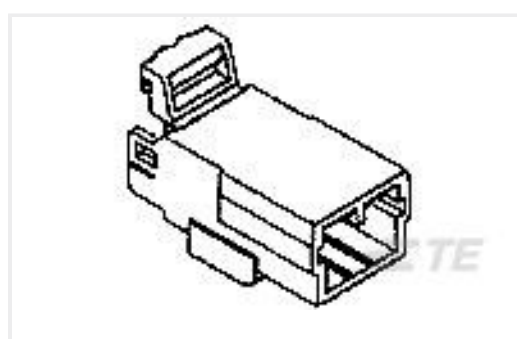

TE Part #174928-1
070 MLC W-W CAP HSG 3P NATURAL

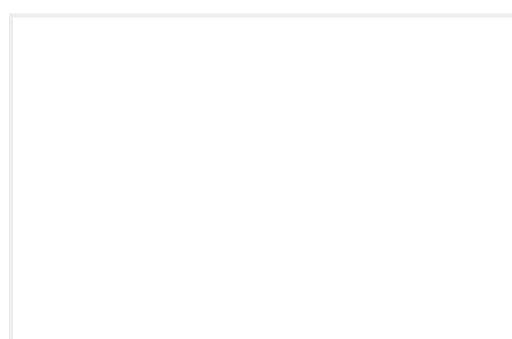

TE Part #1-872575-5
ZAHNRIEMEN

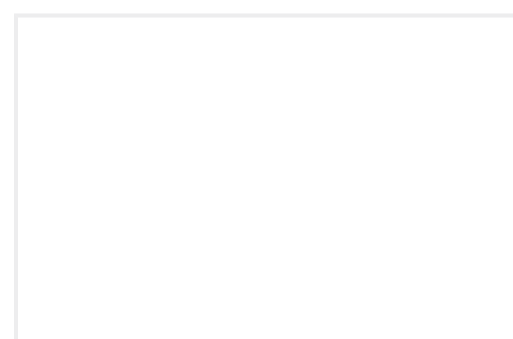

TE Part #539229-1
SCHNITTMESSER

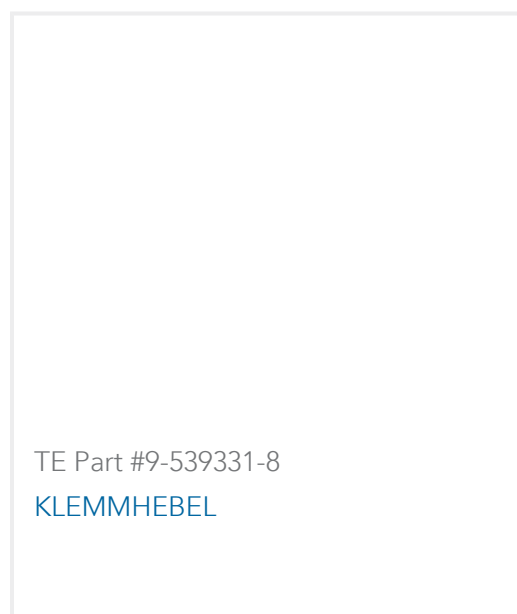

Documents

Product Drawings

LANGUETTE 6,3 NG1

English

CAD Files

Customer View Model

[ENG_CVM_1544218-1_D.3d_igs.zip](#)

English

Customer View Model

[ENG_CVM_1544218-1_D.3d_stp.zip](#)

English

Customer View Model

[ENG_CVM_1544218-1_D.2d_dxf.zip](#)

English

3D PDF

English

By downloading the CAD file I accept and agree to the [Terms and Conditions](#) of use.

Product Specifications

Application Specification

German

Instruction Sheets

Instruction Sheet (non U.S.)

English