

1-1718491-1 ✓ ACTIVE

AMP | AMP MCP Connector System

TE Internal #: 1-1718491-1

Housing for Male Terminals, Wire-to-Wire, 25 Position, 4 mm / 5 mm [.157 in / .197 in] Centerline, Black, Wire & Cable, AMP MCP Connector System

[View on TE.com >](#)



Connectors > Automotive Connectors > Automotive Housings > AMP Unsealed Connector Housing

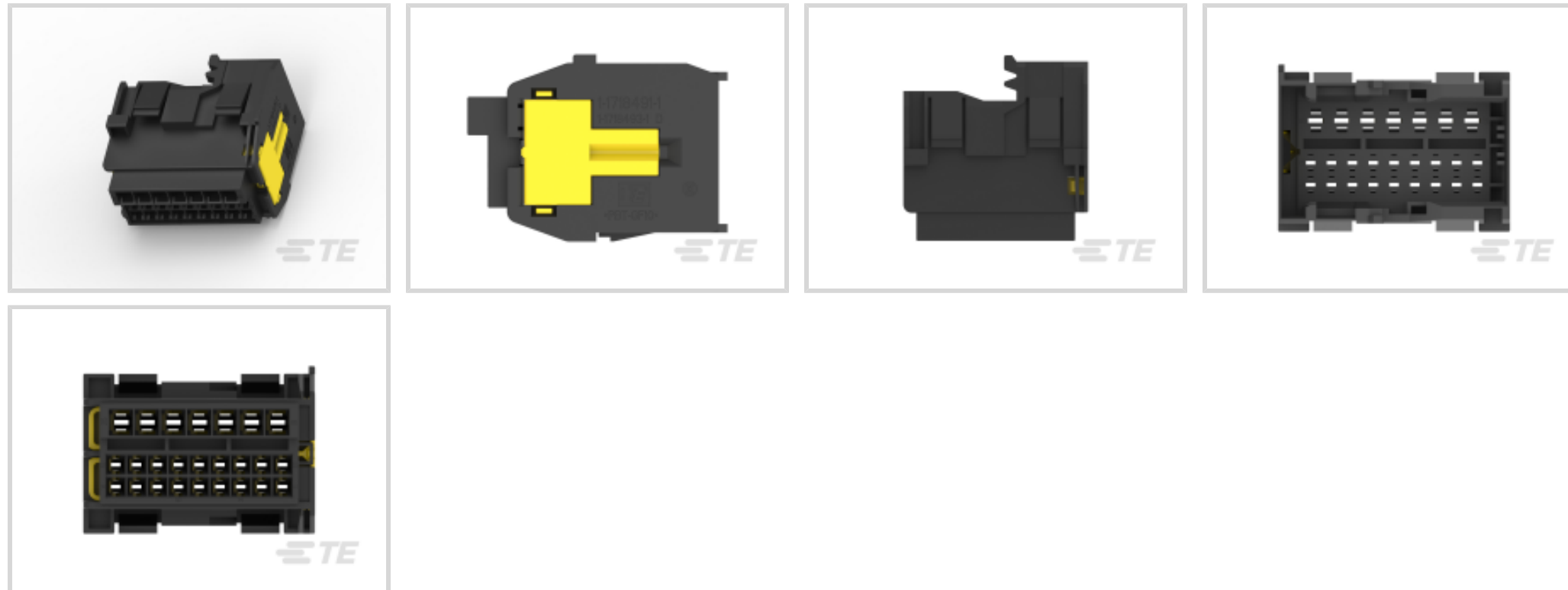

Connector System: **Wire-to-Wire**

Number of Positions: **25**

Connector & Housing Type: **Housing for Male Terminals**

Centerline (Pitch): **4 mm, 5 mm [.157 in, .197 in]**

Sealable: **No**

[All AMP Unsealed Connector Housing \(110\)](#)

## Features

### Product Type Features

Connector System	Wire-to-Wire
Connector & Housing Type	Housing for Male Terminals
Sealable	No
Connector & Contact Terminates To	Wire & Cable
Primary Locking Feature	On the Terminal
Mixed & Hybrid Connector	Yes
Connector Shape	Rectangular

### Configuration Features

Number of Positions	25
Number of Rows	2, 1

### Housing Features

Centerline (Pitch)	4 mm, 5 mm [.157 in][.197 in]
--------------------	-------------------------------



Housing Material	PBT GF10
------------------	----------

### Contact Features

Mating Tab Width	1.6 mm, 2.8 mm [.063 in][.11 in]
Contact Current Rating (Max)	10 A, 30 A
Contact Size	2.8mm, 1.6mm
Contact Type	Tab

### Body Features

Primary Product Color	Black
Connector & Keying Code	A
Cable Exit Angle	180°

### Operation/Application

Circuit Application	Power
---------------------	-------

### Mechanical Attachment

Connector Mounting Type	Cable Mount (Free-Hanging)
Strain Relief	Without
Terminal Position Assurance	No
Mating Alignment Type	Keyed
Mating Alignment	With

### Usage Conditions

Operating Temperature (Max)	120 °C[248 °F]
Operating Temperature Range	-40 – 120 °C[-40 – 248 °F]

### Other

Connector Position Assurance Capable	No
EU RoHS Compliance	Compliant
EU ELV Compliance	Compliant
Serviceable	Yes

### Electrical Characteristics

Operating Voltage	36 VDC
-------------------	--------

### Dimensions

Product Width	30.6 mm[1.2 in]
Product Length	44.5 mm[1.75 in]
Connector Height	43.1 mm[1.69 in]

### Industry Standards

UL Flammability Rating	UL 94HB
------------------------	---------

### Packaging Features

Packaging Method	Box
------------------	-----

### Product Compliance

[For compliance documentation, visit the product page on TE.com>](#)

EU RoHS Directive 2011/65/EU	Compliant
EU ELV Directive 2000/53/EC	Compliant
China RoHS 2 Directive MIIT Order No 32, 2016	No Restricted Materials Above Threshold
EU REACH Regulation (EC) No. 1907/2006	Current ECHA Candidate List: JUNE 2024 (241) Candidate List Declared Against: JUNE 2024 (241) Does not contain REACH SVHC
Halogen Content	Low Halogen - Br, Cl, F, I < 900 ppm per homogenous material. Also BFR/CFR/PVC Free
Solder Process Capability	Not applicable for solder process capability

#### Product Compliance Disclaimer

This information is provided based on reasonable inquiry of our suppliers and represents our current actual knowledge based on the information they provided. This information is subject to change. The part numbers that TE has identified as EU RoHS compliant have a maximum concentration of 0.1% by weight in homogenous materials for lead, hexavalent chromium, mercury, PBB, PBDE, DBP, BBP, DEHP, DIBP, and 0.01% for cadmium, or qualify for an exemption to these limits as defined in the Annexes of Directive 2011/65/EU (RoHS2). Finished electrical and electronic equipment products will be CE marked as required by Directive 2011/65/EU. Components may not be CE marked. Additionally, the part numbers that TE has identified as EU ELV compliant have a maximum concentration of 0.1% by weight in homogenous materials for lead, hexavalent chromium, and mercury, and 0.01% for cadmium, or qualify for an exemption to these limits as defined in the Annexes of Directive 2000/53/EC (ELV). Regarding the REACH Regulation, the information TE provides on SVHC in articles for this part number is based on the latest European Chemicals Agency (ECHA) 'Guidance on requirements for substances in articles' posted at this URL: <https://echa.europa.eu/guidance-documents/guidance-on-reach>

### Compatible Parts



TE Part # CAT-T4827-T273  
TIMER, RECEPTACLE AND TAB



TE Part # 1-2141846-1  
CARRIER, RECEPTACLE HSG, 25 POS, ASSY



TE Part # 2-962842-2  
TAB 2.8x0.8 CONTACT CF SRC Ag



TE Part # 2-962843-2  
TAB 2.8x0.8 CONTACT CF SRC Ag

## Also in the Series | AMP MCP Connector System

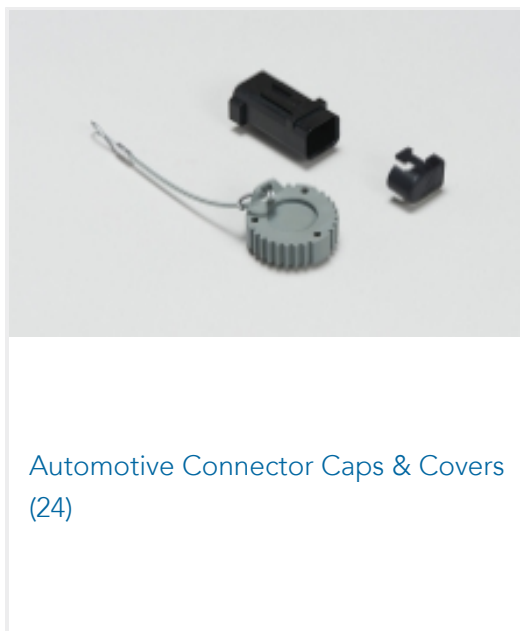

Automotive Connector Caps & Covers (24)

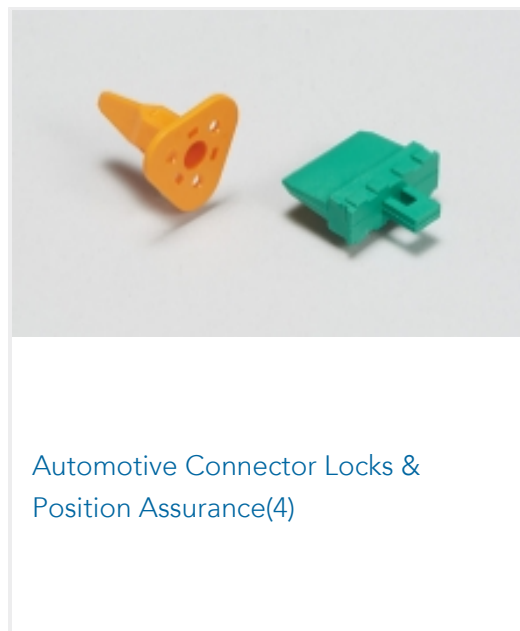

Automotive Connector Locks & Position Assurance (4)

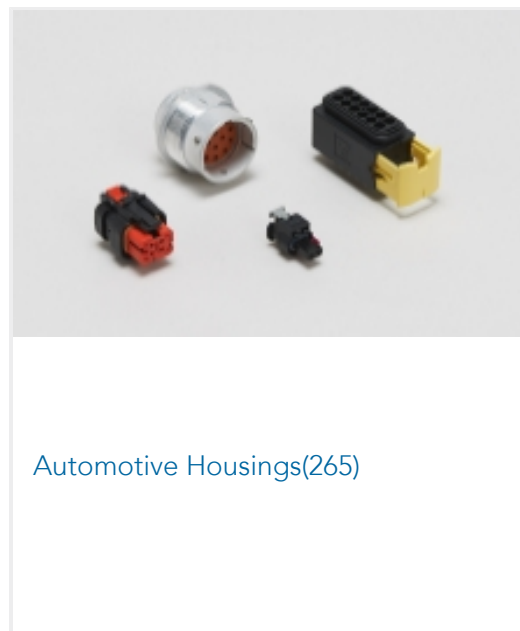

Automotive Housings (265)

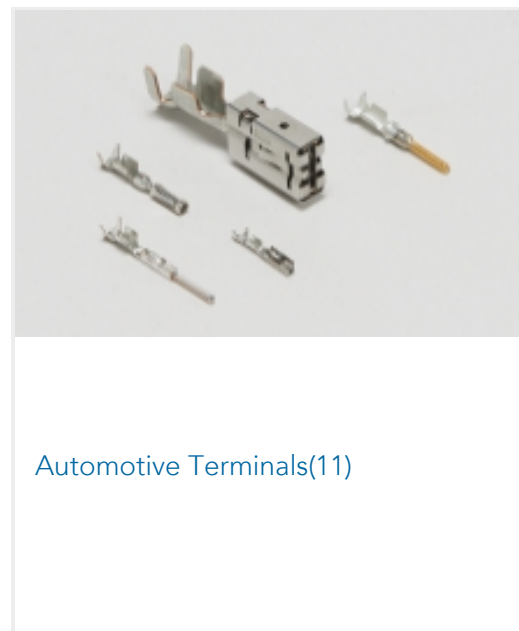

Automotive Terminals (11)

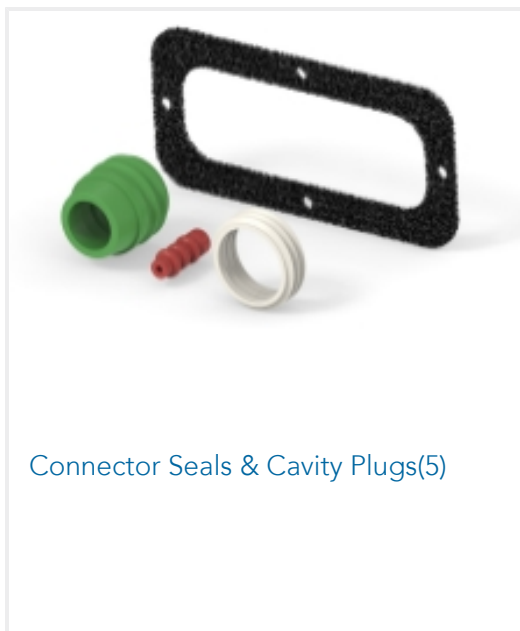

Connector Seals & Cavity Plugs (5)

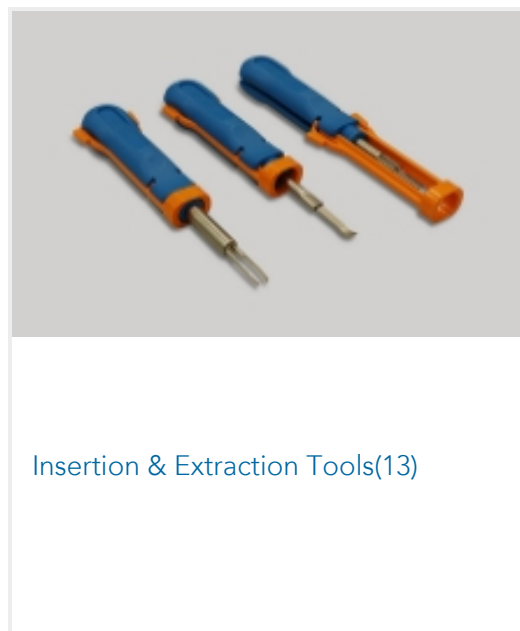

Insertion & Extraction Tools (13)

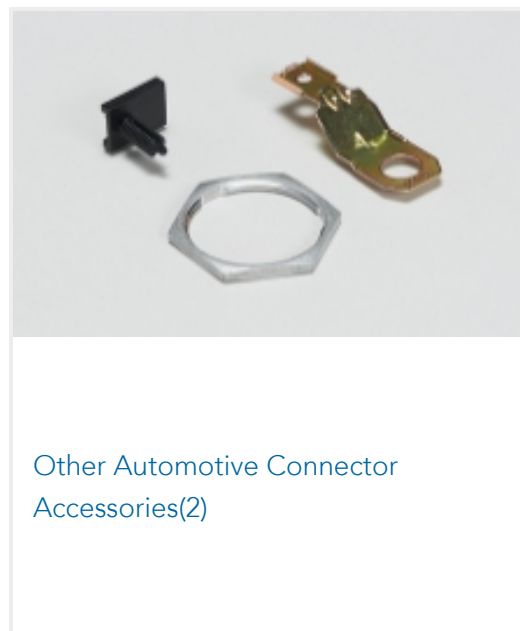

Other Automotive Connector Accessories (2)



PCB Headers & Receptacles (32)

## Customers Also Bought



TE Part #1-1718484-2  
CARRIER FOR RECEPTACLE INSERTS



TE Part #1-1718484-1  
AMP Unsealed Connector Housing



TE Part #965999-1  
JPT A REC 2.8 Contact SRC Sn



TE Part #1-1718492-4  
1.5MM TAB HSG 36 POS ASSY



TE Part #280073  
FF 375 REC HSG 4P NYLON NAT



TE Part #282956-1  
SPLASH PROOF FEM CONN ASSY



TE Part #1-926522-2  
PL 250 REC HSG 2P NYLON NAT

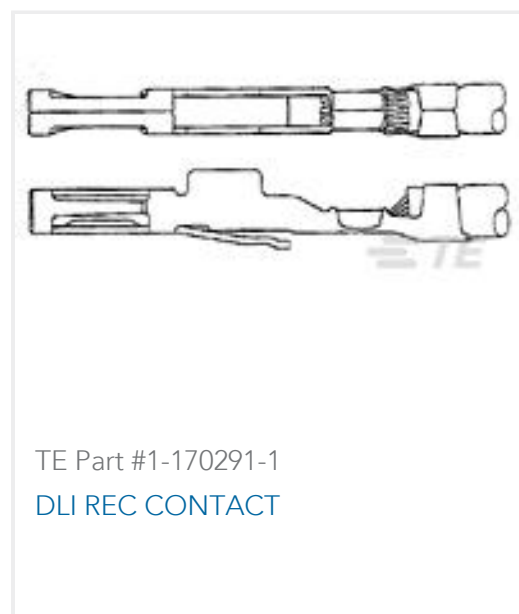

TE Part #1-170291-1  
DLI REC CONTACT



## Documents

### Product Drawings

[1.5/2.8MMTAB HSG 25POS ASSY](#)

English

### CAD Files

Customer View Model

[ENG\\_CVM\\_CVM\\_1-1718491-1\\_D.2d\\_dxf.zip](#)

English

3D PDF

3D

Customer View Model

[ENG\\_CVM\\_CVM\\_1-1718491-1\\_D.3d\\_igs.zip](#)

English

Customer View Model

[ENG\\_CVM\\_CVM\\_1-1718491-1\\_D.3d\\_stp.zip](#)

English

By downloading the CAD file I accept and agree to the [Terms and Conditions](#) of use.

### Product Specifications

[Application Specification](#)

German