

1670789-1 ✓ ACTIVE

AMP | AMP MCP Connector System

TE Internal #: 1670789-1

TPA (Terminal Position Assurance), Red, PBT GF, -40 – 120 °C [-40 – 248 °F], AMP MCP Connector System, Automotive Connector Locks & Position Assurance

[View on TE.com >](#)



Connectors > Automotive Connectors > Automotive Connector Accessories > Automotive Connector Locks & Position Assurance



Connector & Contact Retention Accessory Type: **TPA (Terminal Position Assurance)**

Primary Product Color: **Red**

Primary Product Material: **PBT GF**

Operating Temperature Range: **-40 – 120 °C [-40 – 248 °F]**

EU RoHS Compliance: **Compliant**

## Features

### Product Type Features

Connector & Contact Retention Accessory Type	TPA (Terminal Position Assurance)
--	-----------------------------------

### Body Features

Primary Product Color	Red
Primary Product Material	PBT GF

### Usage Conditions

Operating Temperature Range	-40 – 120 °C[-40 – 248 °F]
-----------------------------	----------------------------

### Other

EU RoHS Compliance	Compliant
EU ELV Compliance	Compliant
Serviceable	Yes

### Industry Standards

UL Flammability Rating	UL 94V-0
------------------------	----------

### Packaging Features

--	--



Packaging Method	Box & Carton
Packaging Quantity	1200

### Product Compliance

[For compliance documentation, visit the product page on TE.com>](#)

EU RoHS Directive 2011/65/EU	Compliant
EU ELV Directive 2000/53/EC	Compliant
China RoHS 2 Directive MIIT Order No 32, 2016	No Restricted Materials Above Threshold
EU REACH Regulation (EC) No. 1907/2006	Current ECHA Candidate List: JUNE 2024 (241) Candidate List Declared Against: JUNE 2024 (241) Does not contain REACH SVHC
Halogen Content	Not Low Halogen - contains Br or Cl > 900 ppm.
Solder Process Capability	Not applicable for solder process capability

#### Product Compliance Disclaimer

This information is provided based on reasonable inquiry of our suppliers and represents our current actual knowledge based on the information they provided. This information is subject to change. The part numbers that TE has identified as EU RoHS compliant have a maximum concentration of 0.1% by weight in homogenous materials for lead, hexavalent chromium, mercury, PBB, PBDE, DBP, BBP, DEHP, DIBP, and 0.01% for cadmium, or qualify for an exemption to these limits as defined in the Annexes of Directive 2011/65/EU (RoHS2). Finished electrical and electronic equipment products will be CE marked as required by Directive 2011/65/EU. Components may not be CE marked. Additionally, the part numbers that TE has identified as EU ELV compliant have a maximum concentration of 0.1% by weight in homogenous materials for lead, hexavalent chromium, and mercury, and 0.01% for cadmium, or qualify for an exemption to these limits as defined in the Annexes of Directive 2000/53/EC (ELV). Regarding the REACH Regulation, the information TE provides on SVHC in articles for this part number is based on the latest European Chemicals Agency (ECHA) 'Guidance on requirements for substances in articles' posted at this URL: <https://echa.europa.eu/guidance-documents/guidance-on-reach>

### Compatible Parts



Also in the Series | [AMP MCP Connector System](#)

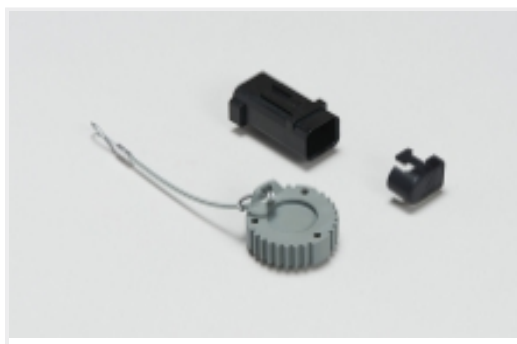

Automotive Connector Caps & Covers (24)

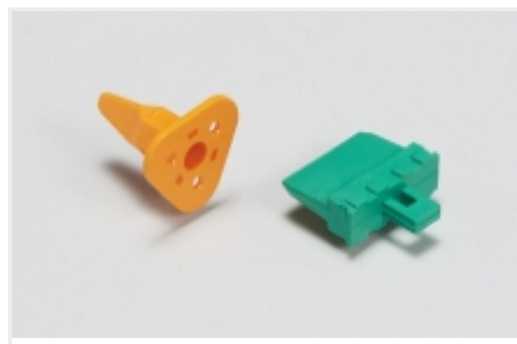

Automotive Connector Locks & Position Assurance(4)

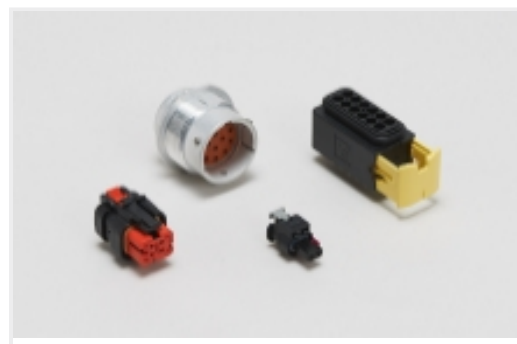

Automotive Housings(265)

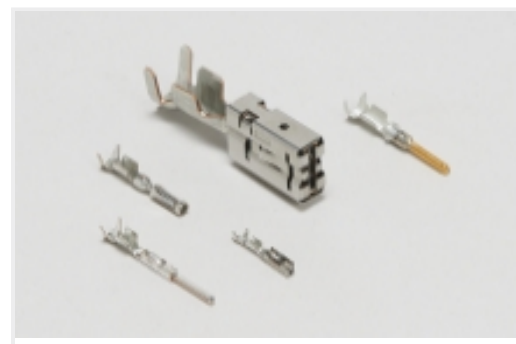

Automotive Terminals(11)



Connector Seals & Cavity Plugs(5)

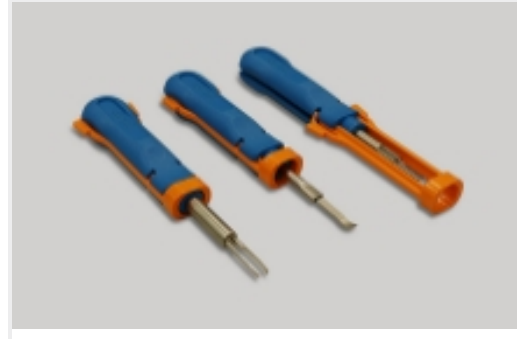

Insertion & Extraction Tools(13)



Other Automotive Connector Accessories(2)

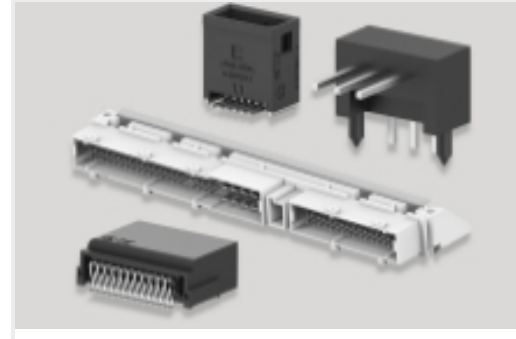

PCB Headers & Receptacles(32)

## Customers Also Bought



TE Part #178125-1  
U/POWER PLUG HSG 2P 7.92M/M



TE Part #350557-1  
MNL SOK SPECIAL .0126PTPBR



TE Part #1-2112780-9  
AMP MCP, SEALED CONNECTOR HOUSING

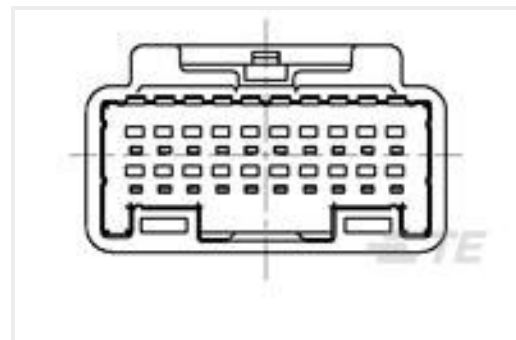

TE Part #1473750-1  
025 20POS CAP ASSY W TO W

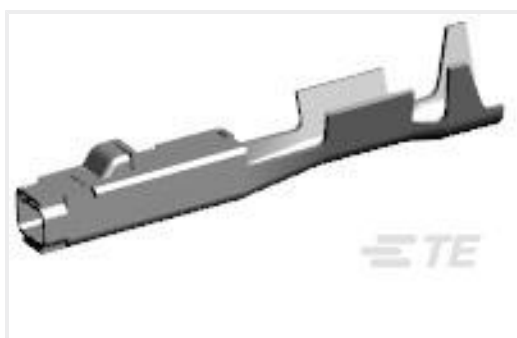

TE Part #1670144-1  
MCON 1.2 CB REC SRC SN



TE Part #2373835-1  
2POS,MQS,REC HSG ASSY,SLD,COD A

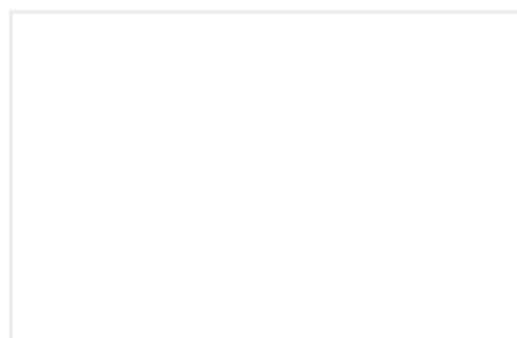

TE Part #2112758-1  
COVER

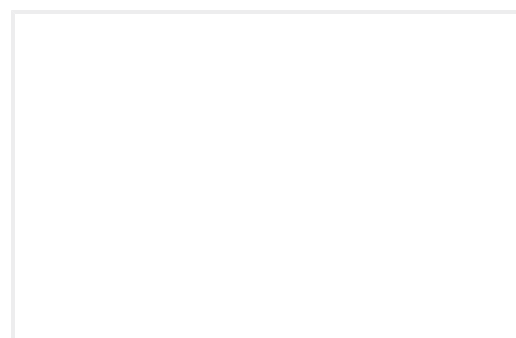

TE Part #1-2066502-1  
COVER, 2POS MINI FUSE BOX HOUSING, MAT-2

## Documents

### Product Drawings

2. LOCK

English

2. LOCK

English

### CAD Files

3D PDF



3D

**Customer View Model**

[ENG\\_CVM\\_CVM\\_1670789-1\\_A.2d\\_dxf.zip](#)

English

**Customer View Model**

[ENG\\_CVM\\_CVM\\_1670789-1\\_A.3d\\_igs.zip](#)

English

**Customer View Model**

[ENG\\_CVM\\_CVM\\_1670789-1\\_A.3d\\_stp.zip](#)

English

By downloading the CAD file I accept and agree to the [Terms and Conditions](#) of use.

**Product Specifications**

[Application Specification](#)

English