

3-520133-2 ✓ ACTIVE

Ultra-Fast | Ultra-Fast 250

TE Internal #: 3-520133-2

Receptacle, 16 – 14 AWG Wire Size, 1.31 – 2.08 mm<sup>2</sup> Wire Size,  
Mating Tab Width 6.35 mm [.25 in], Flag, Brass, Ultra-Fast 250,  
Quick Disconnects

[View on TE.com >](#)



Terminals & Splices > Quick Disconnects

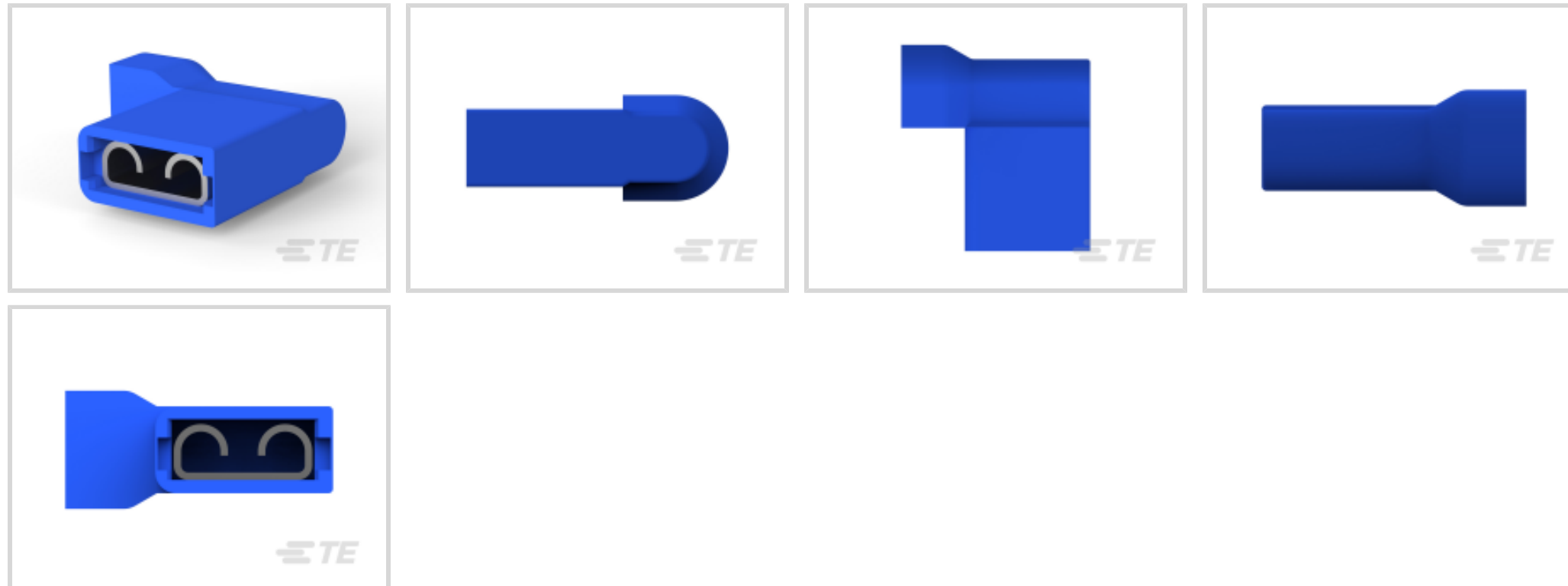

Quick Disconnect Terminal Type: **Receptacle**

Wire Size: 1.31 – 2.08 mm<sup>2</sup>

Mating Tab Width: 6.35 mm [.25 in]

Mating Tab Thickness: .81 mm [.032 in]

## Features

### Contact Features

Quick Disconnect Terminal Type	Receptacle
Mating Tab Width	6.35 mm [.25 in]
Mating Tab Thickness	.81 mm [.032 in]
Terminal Orientation	Flag
Contact Base Material	Brass
Terminal Plating Material	Tin
Crimp Type	F-Crimp
Barrel Type	Closed

### Dimensions

Wire Size	1.31 – 2.08 mm <sup>2</sup>
Product Length	14.73 mm [.58 in]
Compatible Insulation Diameter Range	4.7 mm [.185 in]
Terminal Material Thickness	.41 mm [.016 in]

### Packaging Features

Packaging Method	Loose Piece/Carton
------------------	--------------------



Packaging Quantity	1000
--------------------	------

### Product Type Features

Insertion Force	Low
-----------------	-----

### Usage Conditions

Insulation Option	Fully Insulated
-------------------	-----------------

Operating Temperature Range	-40 – 110 °C[-40 – 230 °F]
-----------------------------	----------------------------

### Other

EU RoHS Compliance	Compliant
--------------------	-----------

EU ELV Compliance	Compliant
-------------------	-----------

Barrel Color	Blue
--------------	------

### Configuration Features

Compatible With Wire & Cable Type	Discrete Wire
-----------------------------------	---------------

Connection Capacity	Single
---------------------	--------

### Electrical Characteristics

Voltage Rating	600 V
----------------	-------

### Body Features

Insulation Material	Nylon
---------------------	-------

### Termination Features

Product Terminates To	Wire & Cable
-----------------------	--------------

### Mechanical Attachment

Wire Insulation Support	With
-------------------------	------

Mating Retention Type	Dimple
-----------------------	--------

### Industry Standards

Compatible With Agency/Standards Products	UL
---	----

UL Flammability Rating	UL 94V-2
------------------------	----------

Compatible With Approved Standards Products	CSA LR7189, UL E66717
---	-----------------------

### Product Compliance

[For compliance documentation, visit the product page on TE.com>](#)

EU RoHS Directive 2011/65/EU	Compliant
------------------------------	-----------

EU ELV Directive 2000/53/EC	Compliant
-----------------------------	-----------



China RoHS 2 Directive MIIT Order No 32, 2016	No Restricted Materials Above Threshold
EU REACH Regulation (EC) No. 1907/2006	Current ECHA Candidate List: JUNE 2024 (241) Candidate List Declared Against: JUNE 2024 (241) Does not contain REACH SVHC
Halogen Content	Low Halogen - Br, Cl, F, I < 900 ppm per homogenous material. Also BFR/CFR/PVC Free
Solder Process Capability	Not applicable for solder process capability

Product Compliance Disclaimer

This information is provided based on reasonable inquiry of our suppliers and represents our current actual knowledge based on the information they provided. This information is subject to change. The part numbers that TE has identified as EU RoHS compliant have a maximum concentration of 0.1% by weight in homogenous materials for lead, hexavalent chromium, mercury, PBB, PBDE, DBP, BBP, DEHP, DIBP, and 0.01% for cadmium, or qualify for an exemption to these limits as defined in the Annexes of Directive 2011/65/EU (RoHS2). Finished electrical and electronic equipment products will be CE marked as required by Directive 2011/65/EU. Components may not be CE marked. Additionally, the part numbers that TE has identified as EU ELV compliant have a maximum concentration of 0.1% by weight in homogenous materials for lead, hexavalent chromium, and mercury, and 0.01% for cadmium, or qualify for an exemption to these limits as defined in the Annexes of Directive 2000/53/EC (ELV). Regarding the REACH Regulation, the information TE provides on SVHC in articles for this part number is based on the latest European Chemicals Agency (ECHA) 'Guidance on requirements for substances in articles' posted at this URL: <https://echa.europa.eu/guidance-documents/guidance-on-reach>

### Compatible Parts



### Also in the Series | Ultra-Fast 250

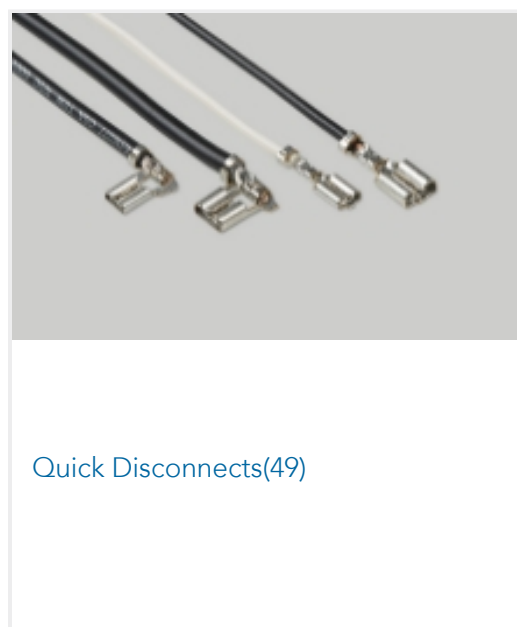
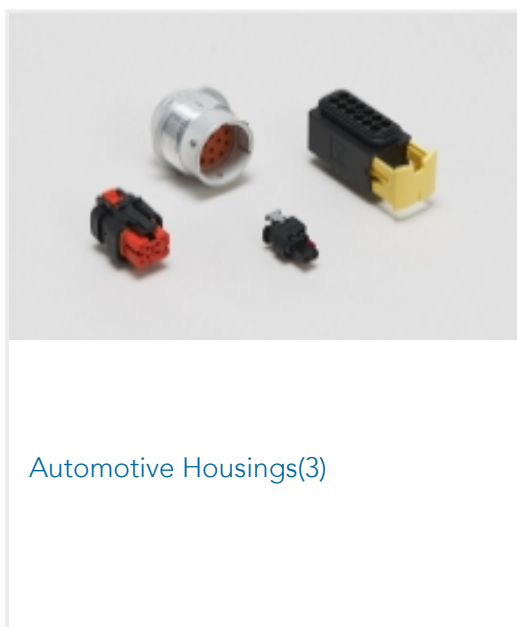

### Customers Also Bought

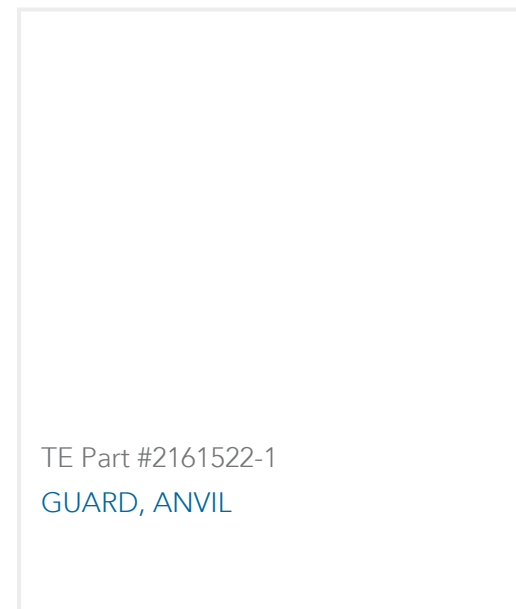
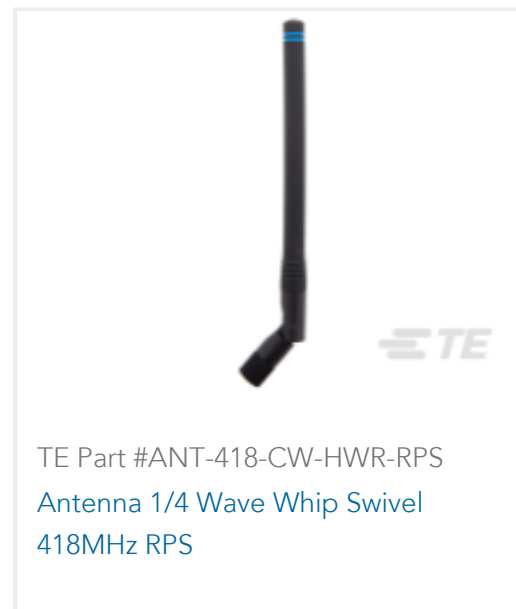
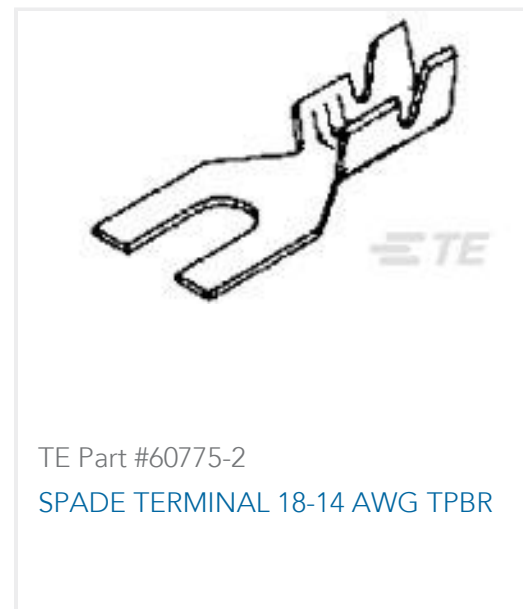
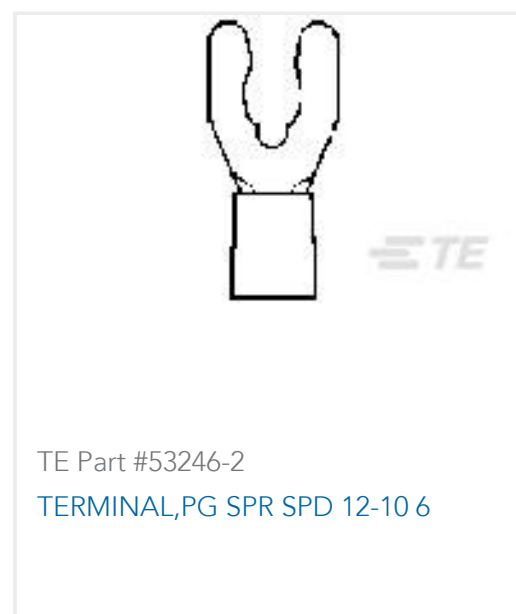

## Documents

### Product Drawings

[ULTRA-FAST 250 ASY REC 16-14 AWG TPBR](#)

English

### CAD Files

[3D PDF](#)

3D

Customer View Model

[ENG\\_CVM\\_CVM\\_3-520133-2\\_P.2d\\_dxf.zip](#)

English

Customer View Model

[ENG\\_CVM\\_CVM\\_3-520133-2\\_P.3d\\_igs.zip](#)

English

Customer View Model

[ENG\\_CVM\\_CVM\\_3-520133-2\\_P.3d\\_stp.zip](#)

English

By downloading the CAD file I accept and agree to the [Terms and Conditions](#) of use.

### Datasheets & Catalog Pages



## Ultra-Fast and Ultra Fast Plus

English

---

## Product Specifications

### Application Specification

English

---

## Agency Approvals

### UL

English