

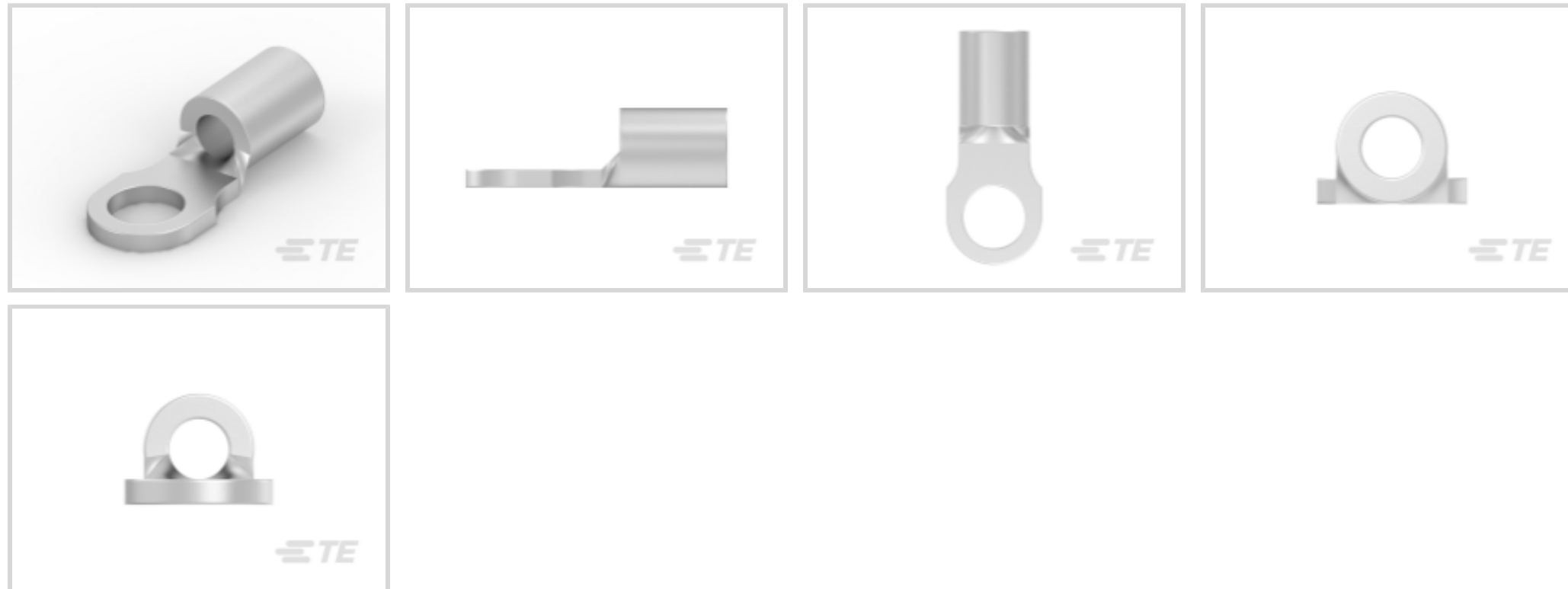

Terminals & Splices > Ring Terminals



Ring Terminal Product Type: **Closed Ring Tongue Terminal**

Wire Size: **509 – 3260 CMA**

Stud Size: **#4**

### Features

#### Product Type Features

Ring Terminal Product Type	Closed Ring Tongue Terminal
Stud Size	#4
Sealable	No
Wire Insulation Support Retention Type	Non-Insulation Support

#### Dimensions

Wire Size	509 – 3260 CMA
Stud Diameter	3.02 mm [.119 in]
Tongue Thickness	.79 mm [.031 in]
Product Length	11.33 mm [.446 in]
Barrel Inside Diameter	1.65 mm [.065 in]

#### Contact Features

Barrel Type	Closed
Terminal Orientation	Straight
Terminal Plating Material	Tin

#### Usage Conditions

--	--



Insulation Option	Uninsulated
-------------------	-------------

Operating Temperature Range	170 °C[338 °F]
-----------------------------	----------------

### Operation/Application

Compatible With Wire Base Material	Copper
------------------------------------	--------

Compatible With Wire Plating Material	Tin
---------------------------------------	-----

### Packaging Features

Packaging Method	Loose Piece
------------------	-------------

Packaging Quantity	1000
--------------------	------

### Other

EU RoHS Compliance	Compliant
--------------------	-----------

EU ELV Compliance	Compliant
-------------------	-----------

Line	Budget
------	--------

### Configuration Features

Number of Holes	1
-----------------	---

### Body Features

Product Weight	.347 g
----------------	--------

### Mechanical Attachment

Wire Insulation Support	Without
-------------------------	---------

### Industry Standards

Government Qualified Terminal	No
-------------------------------	----

## Product Compliance

[For compliance documentation, visit the product page on TE.com>](#)

EU RoHS Directive 2011/65/EU	Compliant
------------------------------	-----------

EU ELV Directive 2000/53/EC	Compliant
-----------------------------	-----------

China RoHS 2 Directive MIIT Order No 32, 2016	No Restricted Materials Above Threshold
---	---

EU REACH Regulation (EC) No. 1907/2006	Current ECHA Candidate List: JUNE 2024 (241) Candidate List Declared Against: JUNE 2024 (241) Does not contain REACH SVHC
--	---

Halogen Content	Low Halogen - Br, Cl, F, I < 900 ppm per homogenous material. Also BFR/CFR/PVC Free
-----------------	---



Solder Process Capability

Not applicable for solder process capability

Product Compliance Disclaimer

This information is provided based on reasonable inquiry of our suppliers and represents our current actual knowledge based on the information they provided. This information is subject to change. The part numbers that TE has identified as EU RoHS compliant have a maximum concentration of 0.1% by weight in homogenous materials for lead, hexavalent chromium, mercury, PBB, PBDE, DBP, BBP, DEHP, DIBP, and 0.01% for cadmium, or qualify for an exemption to these limits as defined in the Annexes of Directive 2011/65/EU (RoHS2). Finished electrical and electronic equipment products will be CE marked as required by Directive 2011/65/EU. Components may not be CE marked. Additionally, the part numbers that TE has identified as EU ELV compliant have a maximum concentration of 0.1% by weight in homogenous materials for lead, hexavalent chromium, and mercury, and 0.01% for cadmium, or qualify for an exemption to these limits as defined in the Annexes of Directive 2000/53/EC (ELV). Regarding the REACH Regulation, the information TE provides on SVHC in articles for this part number is based on the latest European Chemicals Agency (ECHA) 'Guidance on requirements for substances in articles' posted at this URL: <https://echa.europa.eu/guidance-documents/guidance-on-reach>

### Compatible Parts

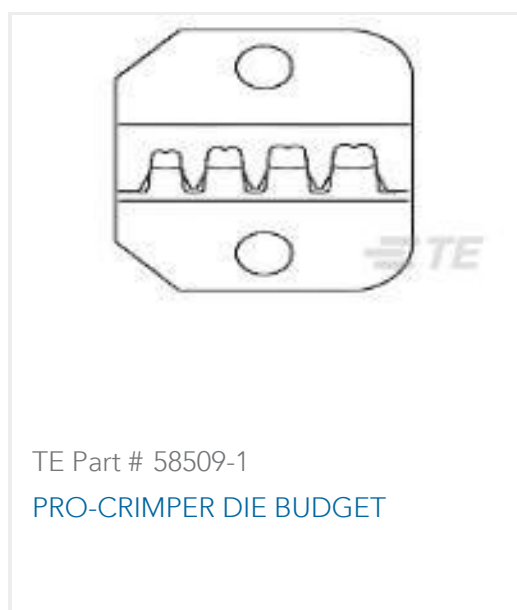

### Also in the Series | SOLISTRAND Budget

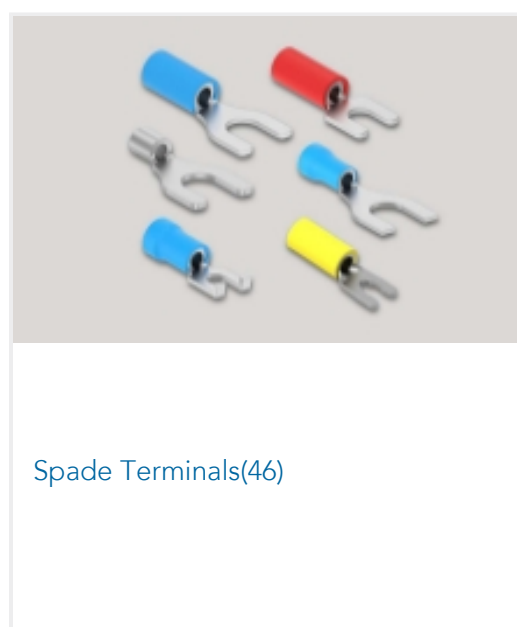
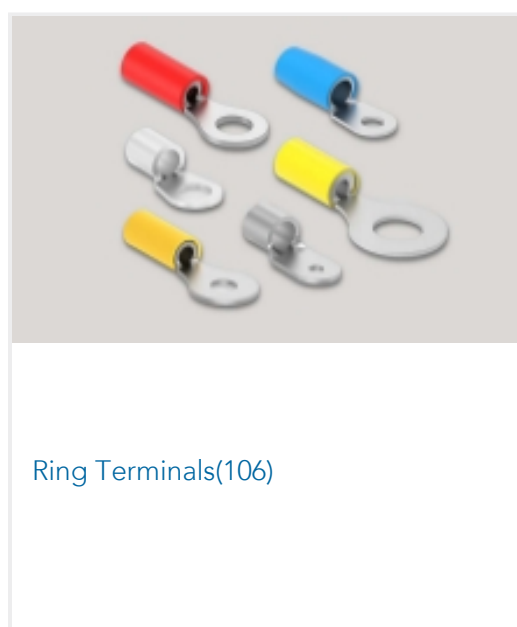

### Customers Also Bought

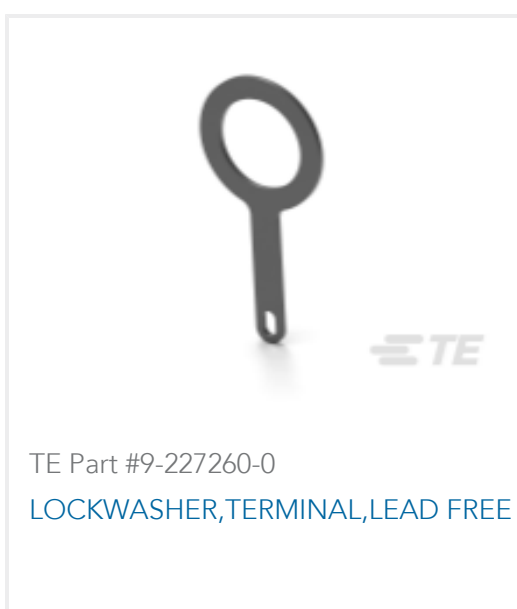

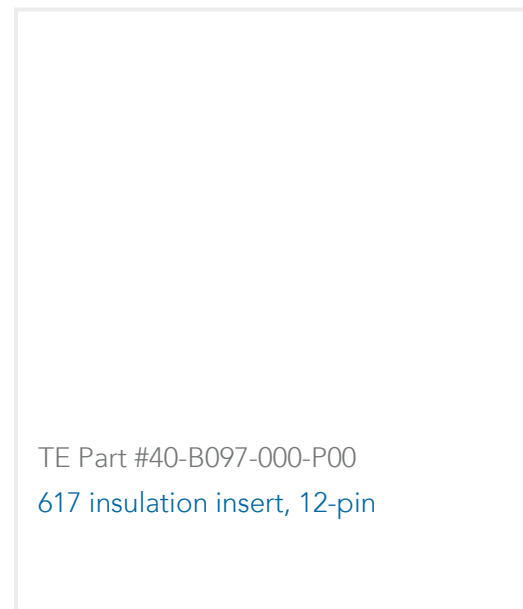
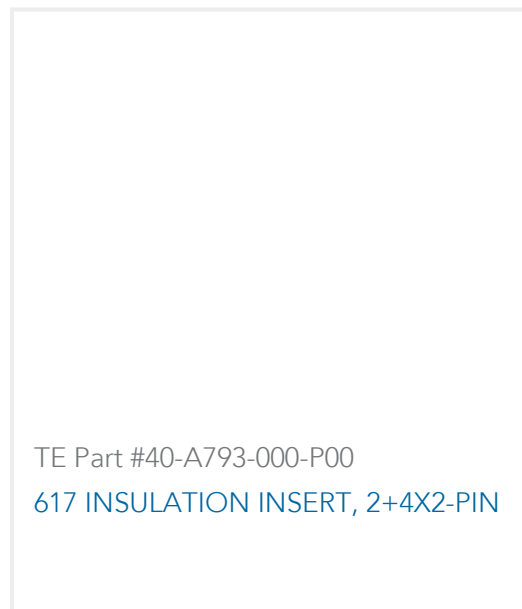
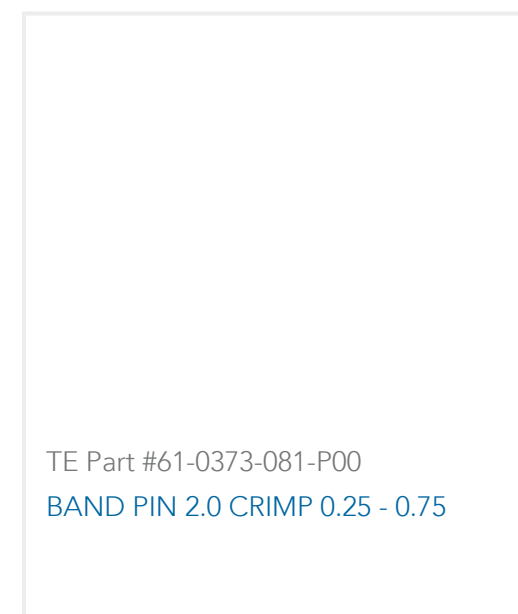
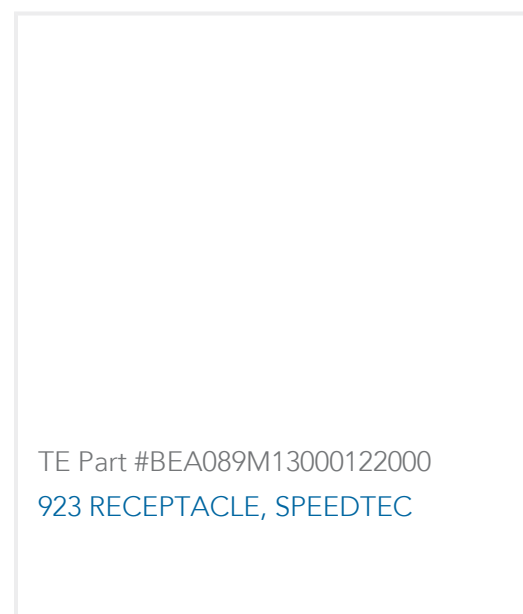

## Documents

### Product Drawings

[BUDG R 22-16 COMM 22-18 MIL 4](#)

English

### CAD Files

Customer View Model

[ENG\\_CVM\\_CVM\\_36189\\_P.2d\\_dxf.zip](#)

English

[3D PDF](#)

3D

Customer View Model

[ENG\\_CVM\\_CVM\\_36189\\_P.3d\\_igs.zip](#)

English

Customer View Model

[ENG\\_CVM\\_CVM\\_36189\\_P.3d\\_stp.zip](#)

English

By downloading the CAD file I accept and agree to the [Terms and Conditions](#) of use.

### Agency Approvals

[UL Report](#)

English