

1971895-2 ✓ ACTIVE

RAST | RAST 5 IDC Connectors

TE Internal #: 1971895-2

PCB Mount Header, Vertical, Wire-to-Board, 2 Position, 5 mm [.197 in] Centerline, Fully Shrouded, Tin, Through Hole - Solder, RAST 5 IDC Connectors

[View on TE.com >](#)



Connectors > PCB Connectors > PCB Headers & Receptacles

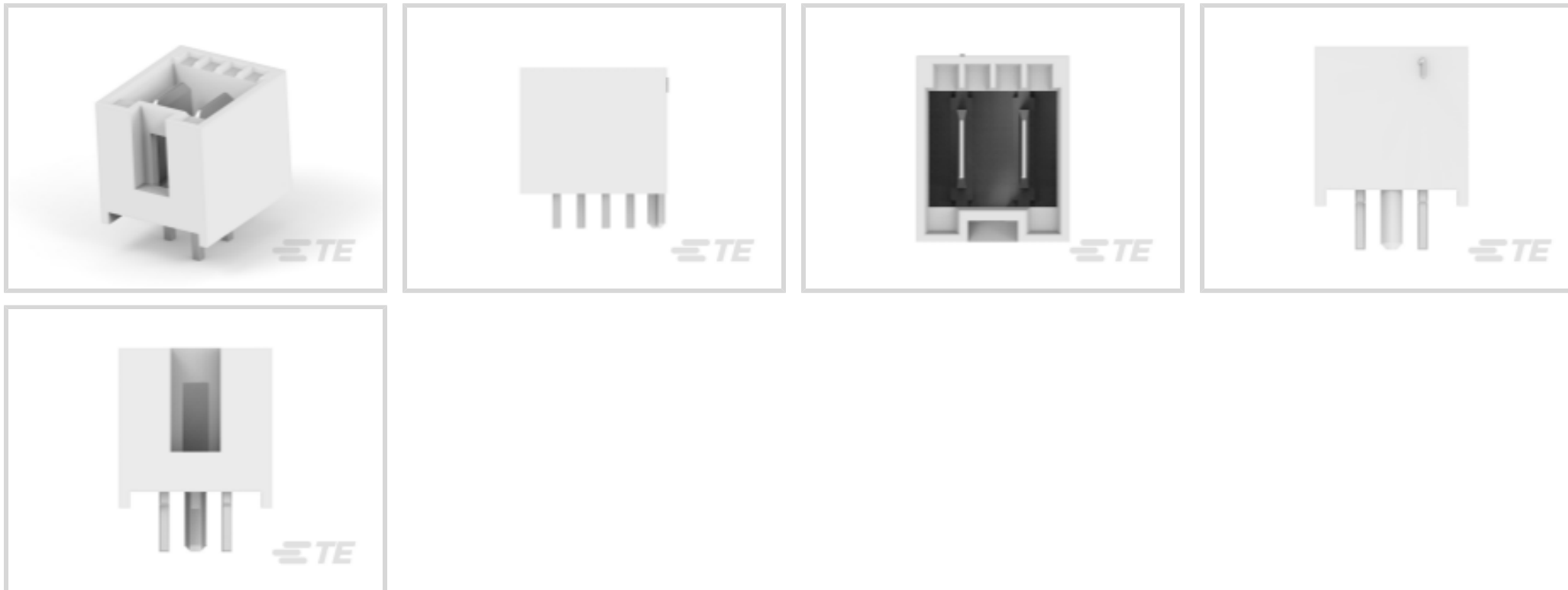

EU RoHS Compliance: **Compliant**

EU ELV Compliance: **Compliant**

PCB Connector Assembly Type: **PCB Mount Header**

PCB Mount Orientation: **Vertical**

Connector System: **Wire-to-Board**

Features

Other

EU RoHS Compliance	Compliant
EU ELV Compliance	Compliant

Product Type Features

PCB Connector Assembly Type	PCB Mount Header
Connector System	Wire-to-Board
Header Type	Fully Shrouded
Connector & Contact Terminates To	Printed Circuit Board

Configuration Features

Keying & Polarized Position Locations	1C, 2D
PCB Mount Orientation	Vertical
Number of Positions	2
Number of Rows	1

Electrical Characteristics

Operating Voltage	250 VAC
-------------------	---------



Body Features

Primary Product Color	Natural
-----------------------	---------

Contact Features

PCB Contact Termination Area Plating Material Finish	Matte
Contact Mating Area Plating Material Thickness	3.8 µm[149.6 µin]
Mating Tab Width	6.3 mm[.248 in]
PCB Contact Termination Area Plating Material Thickness	3.8 µm[149.6 µin]
Contact Shape & Form	Square
Contact Base Material	Copper Alloy
Mating Tab Thickness	.8 mm[.032 in]
PCB Contact Termination Area Plating Material	Tin
Contact Mating Area Plating Material Finish	Matte
Contact Mating Area Plating Material	Tin
Contact Type	Tab
Contact Current Rating (Max)	10 A

Termination Features

Termination Post & Tail Length	3.5 mm[.13 in]
Square Termination Post & Tail Dimension	.8 mm[.032 in]
Termination Method to PCB	Through Hole - Solder

Mechanical Attachment

Mating Retention Type	Latch
Mating Retention	With
Mating Alignment Type	Keyed
PCB Mount Alignment Type	Locating Posts
PCB Mount Retention	Without
PCB Mount Alignment	With
Connector Mounting Type	Board Mount
Mating Alignment	With

Housing Features

Housing Material	Nylon
Centerline (Pitch)	5 mm[.197 in]

Dimensions



Row-to-Row Spacing	2.5 mm
Connector Height	12.8 mm[.5 in]
Connector Length	15.3 mm[.6 in]

Usage Conditions

Operating Temperature Range	-40 – 120 °C[-40 – 248 °F]
-----------------------------	----------------------------

Operation/Application

Circuit Application	Power
---------------------	-------

Industry Standards

UL Flammability Rating	UL 94V-0
------------------------	----------

Packaging Features

Packaging Quantity	153
Packaging Method	Tube, Box

Product Compliance

[For compliance documentation, visit the product page on TE.com>](#)

EU RoHS Directive 2011/65/EU	Compliant
EU ELV Directive 2000/53/EC	Compliant
China RoHS 2 Directive MIIT Order No 32, 2016	No Restricted Materials Above Threshold
EU REACH Regulation (EC) No. 1907/2006	Current ECHA Candidate List: JUNE 2024 (241) Candidate List Declared Against: JUNE 2024 (241) Does not contain REACH SVHC
Halogen Content	Not Low Halogen - contains Br or Cl > 900 ppm.
Solder Process Capability	Not reviewed for solder process capability

Product Compliance Disclaimer

This information is provided based on reasonable inquiry of our suppliers and represents our current actual knowledge based on the information they provided. This information is subject to change. The part numbers that TE has identified as EU RoHS compliant have a maximum concentration of 0.1% by weight in homogenous materials for lead, hexavalent chromium, mercury, PBB, PBDE, DBP, BBP, DEHP, DIBP, and 0.01% for cadmium, or qualify for an exemption to these limits as defined in the Annexes of Directive 2011/65/EU (RoHS2). Finished electrical and electronic equipment products will be CE marked as required by Directive 2011/65/EU. Components may not be CE marked. Additionally, the part numbers that TE has identified as EU ELV compliant have a maximum concentration of 0.1% by weight in homogenous materials for lead, hexavalent chromium, and mercury, and 0.01% for cadmium, or qualify for an exemption to these limits as defined in the Annexes of Directive 2000/53/EC (ELV). Regarding the REACH Regulation, the information TE provides on SVHC in articles for this part number is based on the latest European Chemicals Agency (ECHA) 'Guidance on requirements for substances in articles' posted at this URL: <https://echa.europa.eu/guidance-documents/guidance-on-reach>

Compatible Parts

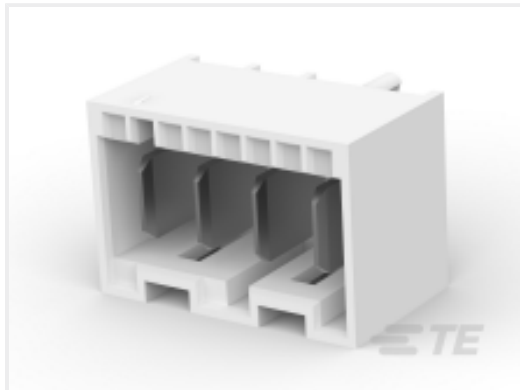

TE Part # 1971845-4
4P, RAST 5 Tab Header, THV



TE Part # 1971845-3
3P, RAST 5 Tab Header, THV

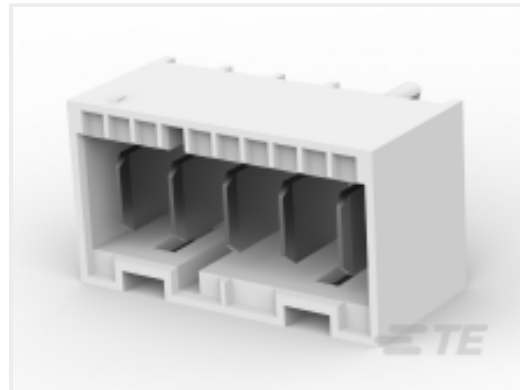

TE Part # 1971845-5
5P, RAST 5 Tab Header, THV



TE Part # 1971845-2
2P, RAST 5 Tab Header, THV

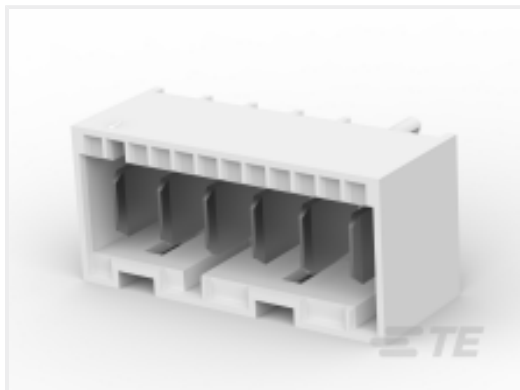

TE Part # 1971845-6
6P, RAST 5 Tab Header, THV

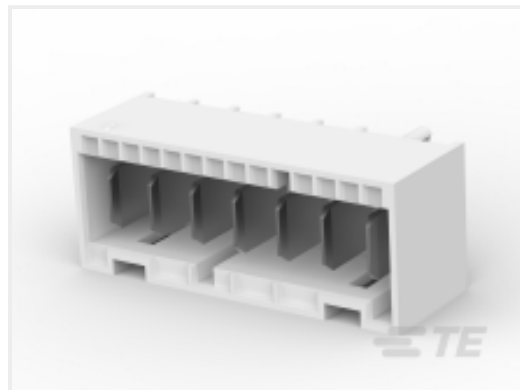

TE Part # 1971845-7
7P, RAST 5 Tab Header, THV



TE Part # 1971895-3
3P, RAST 5 Tab Header, THV



TE Part # 1971895-4
4P, RAST 5 Tab Header, THV



TE Part # 1971895-5
5P, RAST 5 Tab Header, THV

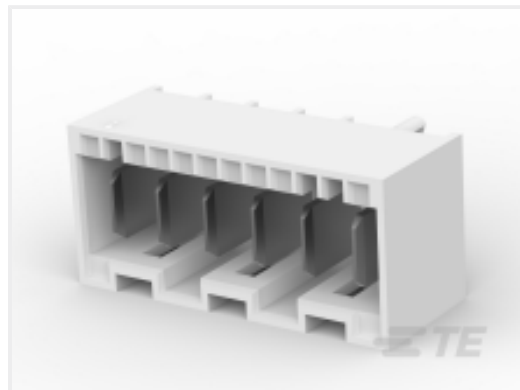

TE Part # 1971895-6
6P, RAST 5 Tab Header, THV



TE Part # 1971895-7
7P, RAST 5 Tab Header, THV

Also in the Series | RAST 5 IDC Connectors

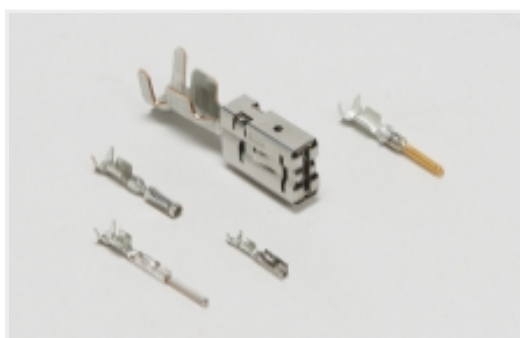

Automotive Terminals(8)



Connector Contacts(14)

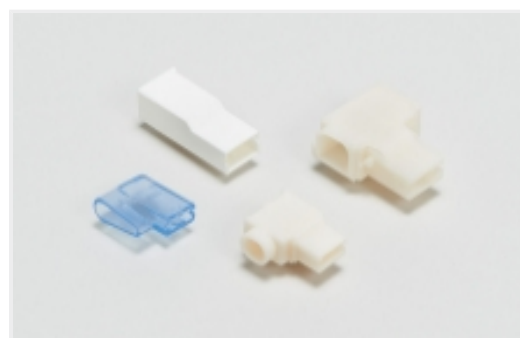

Crimp Terminal Housings(39)



Insertion & Extraction Tools(1)



PCB Headers & Receptacles(417)

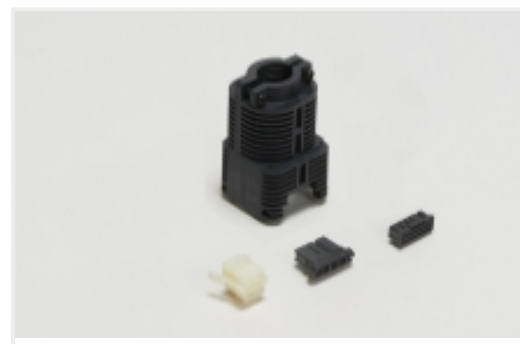

Rectangular Connector Housings(1)

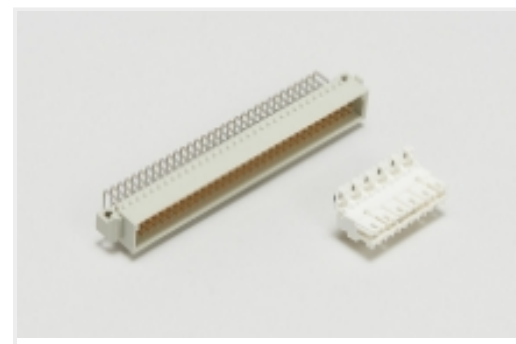

Standard Edge Connectors(32)

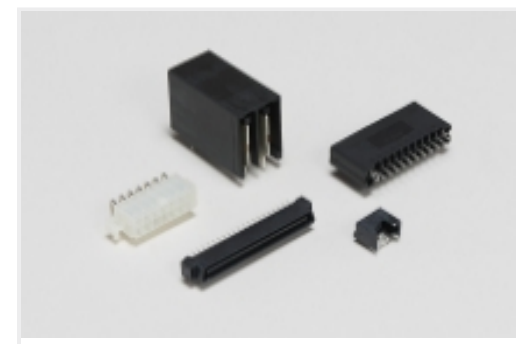

Standard Rectangular Connectors(63)

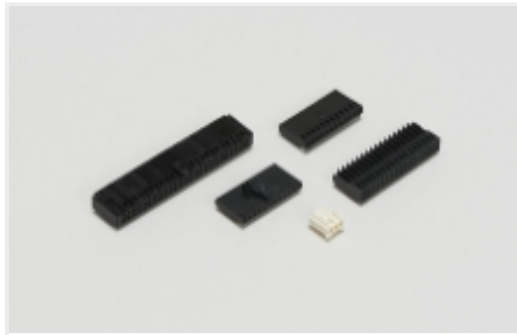
Wire-to-Board Connector Assemblies
& Housings(203)

Customers Also Bought

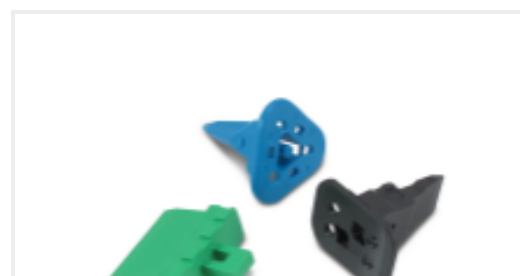
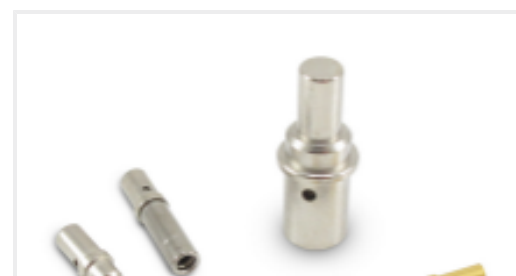
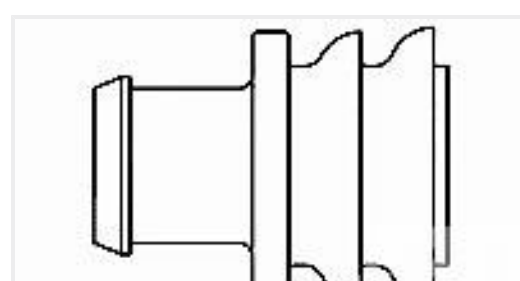
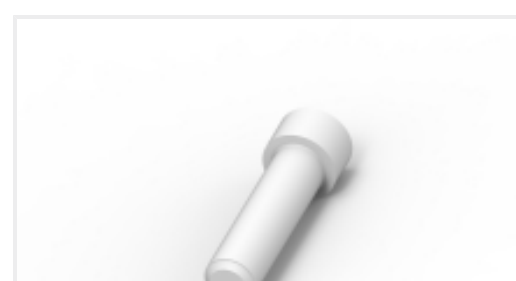
TE Part #DT04-2P
REC, 2P, GRY, NTE Part #W2S
Wedgelocks: DEUTSCH DTTE Part #0460-202-16141
DEUTSCH Solid ContactsTE Part #282104-1
AMP SUPERSEAL 1.5MM,
CONNECTOR HOUSINGTE Part #DT06-2S
PLG, 2P, GRY, NTE Part #281934-2
SINGLE WIRE SEALTE Part #114017-ZZ
SEALING PLUG, SIZE 12/16, WHT

Documents

Product Drawings

2P, RAST 5 Tab Header, THV

English

CAD Files

3D PDF

3D

Customer View Model

ENG_CVM_CVM_1971895-2_B.2d_dxf.zip



English

Customer View Model

[ENG_CVM_CVM_1971895-2_B.3d_igs.zip](#)

English

Customer View Model

[ENG_CVM_CVM_1971895-2_B.3d_stp.zip](#)

English

By downloading the CAD file I accept and agree to the [Terms and Conditions](#) of use.

Datasheets & Catalog Pages

[RAST Connector System Catalog](#)

English

[7-1773465-5 RAST5.0 Flyer](#)

English

Product Specifications

[Product Specification](#)

English

Agency Approvals

[VDE Certificate](#)

English

[VDE Certificate](#)

English