

2132415-9 ✓ ACTIVE

Economy Power 2.5

TE Internal #: 2132415-9

PCB Mount Header, Vertical, Wire-to-Board, 9 Position, 2.5 mm [.098 in] Centerline, Fully Shrouded, Tin, Through Hole - Solder, Economy Power 2.5

[View on TE.com >](#)



Connectors > PCB Connectors > PCB Headers & Receptacles

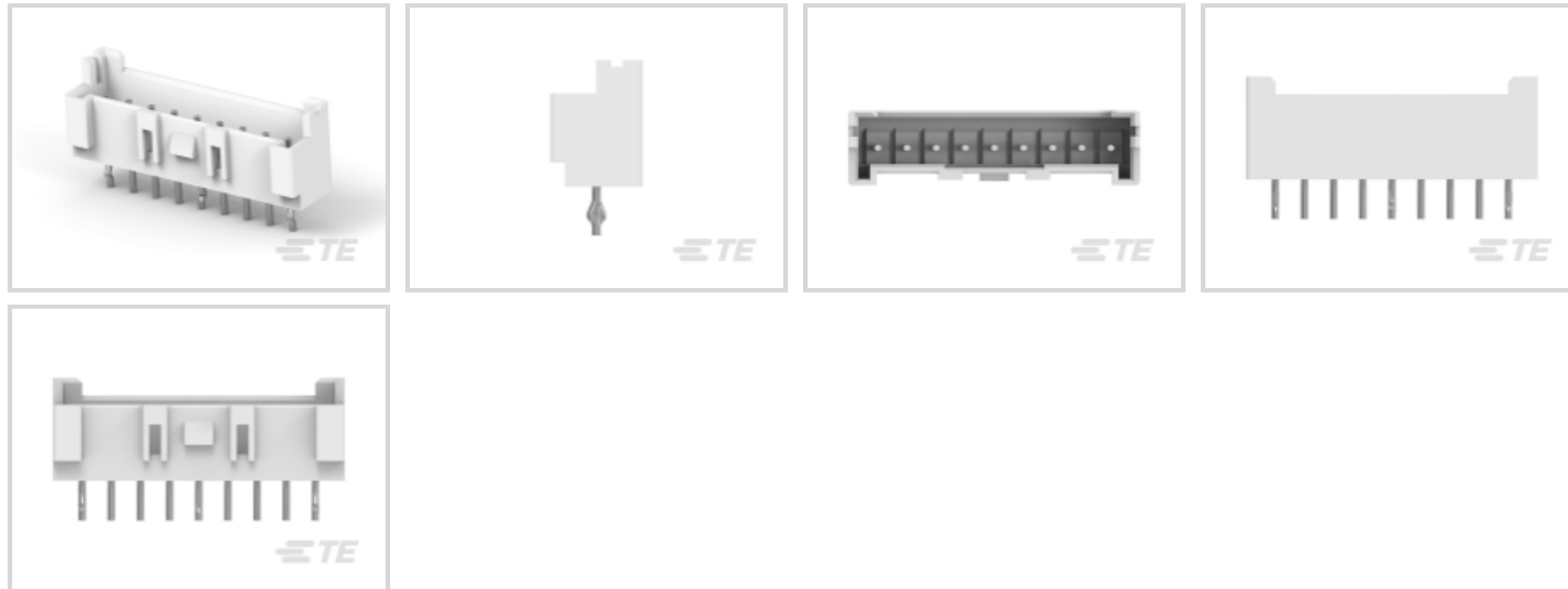

EU RoHS Compliance: **Compliant**

EU ELV Compliance: **Compliant**

PCB Connector Assembly Type: **PCB Mount Header**

PCB Mount Orientation: **Vertical**

Connector System: **Wire-to-Board**

Features

Other

EU RoHS Compliance	Compliant
EU ELV Compliance	Compliant

Product Type Features

PCB Connector Assembly Type	PCB Mount Header
Connector System	Wire-to-Board
Header Type	Fully Shrouded
Sealable	No
Connector & Contact Terminates To	Printed Circuit Board

Configuration Features

Connector Contact Load Condition	Fully Loaded
PCB Mount Orientation	Vertical
Number of Positions	9
Number of Rows	1

Electrical Characteristics



Operating Voltage	250 VAC
-------------------	---------

Body Features

Primary Product Color	Natural
-----------------------	---------

Contact Features

Mating Pin Diameter	.6 mm [.024 in]
---------------------	-----------------

Contact Mating Area Plating Material Thickness	2 – 5 μ m [80 – 200 μ in]
--	-----------------------------------

PCB Contact Termination Area Plating Material Thickness	2.032 μ m [80 μ in]
---	-----------------------------

Contact Shape & Form	Round
----------------------	-------

Contact Layout	Inline
----------------	--------

Contact Mating Area Length	3.6 mm [.142 in]
----------------------------	------------------

Contact Base Material	Brass
-----------------------	-------

PCB Contact Termination Area Plating Material	Tin
---	-----

Contact Mating Area Plating Material Finish	Bright
---	--------

Contact Mating Area Plating Material	Tin
--------------------------------------	-----

Contact Type	Pin
--------------	-----

Contact Current Rating (Max)	4.2 A
------------------------------	-------

Termination Features

Termination Post & Tail Diameter	.6 mm [.024 in]
----------------------------------	-----------------

Termination Post & Tail Length	3.4 mm [.134 in]
--------------------------------	------------------

Termination Method to PCB	Through Hole - Solder
---------------------------	-----------------------

Mechanical Attachment

Mating Retention Type	Latch
-----------------------	-------

Mating Retention	With
------------------	------

Mating Alignment Type	Polarization
-----------------------	--------------

PCB Mount Retention Type	Kinked
--------------------------	--------

PCB Mount Retention	With
---------------------	------

PCB Mount Alignment	Without
---------------------	---------

Connector Mounting Type	Board Mount
-------------------------	-------------

Mating Alignment	With
------------------	------

Housing Features

Housing Material	PBT GF
------------------	--------

Centerline (Pitch)	2.5 mm [.098 in]
--------------------	------------------



Dimensions

Connector Width	6.4 mm[.252 in]
PCB Thickness (Recommended)	1.6 mm[.063 in]
Connector Height	8.8 mm[.346 in]
Connector Length	25 mm[.98 in]

Usage Conditions

Operating Temperature Range	-55 – 105 °C[-67 – 221 °F]
-----------------------------	----------------------------

Operation/Application

Circuit Application	Power & Signal
---------------------	----------------

Industry Standards

Glow Wire Rating	Standard Part - Not Glow Wire
UL Flammability Rating	UL 94V-0

Packaging Features

Packaging Quantity	500
Packaging Method	Bag

Product Compliance

[For compliance documentation, visit the product page on TE.com>](#)

EU RoHS Directive 2011/65/EU	Compliant
EU ELV Directive 2000/53/EC	Compliant
China RoHS 2 Directive MIIT Order No 32, 2016	No Restricted Materials Above Threshold
EU REACH Regulation (EC) No. 1907/2006	Current ECHA Candidate List: JUNE 2024 (241) Candidate List Declared Against: JUNE 2024 (241) Does not contain REACH SVHC
Halogen Content	Not Low Halogen - contains Br or Cl > 900 ppm.
Solder Process Capability	Wave solder capable to 265°C

Product Compliance Disclaimer

This information is provided based on reasonable inquiry of our suppliers and represents our current actual knowledge based on the information they provided. This information is subject to change. The part numbers that TE has identified as EU RoHS compliant have a maximum concentration of 0.1% by weight in homogenous materials for lead, hexavalent chromium, mercury, PBB, PBDE, DBP, BBP, DEHP, DIBP, and 0.01% for cadmium, or qualify for an exemption to these limits as defined in the Annexes of Directive 2011/65/EU (RoHS2). Finished electrical and electronic equipment products will be CE marked as required by Directive 2011/65/EU. Components may not be CE marked. Additionally, the part numbers that TE has identified as EU ELV compliant have a maximum concentration of 0.1% by weight in homogenous



materials for lead, hexavalent chromium, and mercury, and 0.01% for cadmium, or qualify for an exemption to these limits as defined in the Annexes of Directive 2000/53/EC (ELV). Regarding the REACH Regulation, the information TE provides on SVHC in articles for this part number is based on the latest European Chemicals Agency (ECHA) 'Guidance on requirements for substances in articles' posted at this URL: <https://echa.europa.eu/guidance-documents/guidance-on-reach>

Compatible Parts



TE Part # 1969442-9
EP 2.5 TPA Housing, 9 Pos



TE Part # 1744417-9
9 POS EP 2.5 HSG, GLOW WIRE



TE Part # 1969729-9
EP2.5 Shrouded HDR ASSY 9P VERT w /o boss

Also in the Series | Economy Power 2.5



Connector Contacts(6)

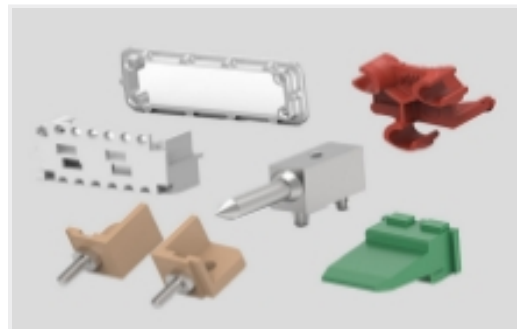

Connector Hardware(49)

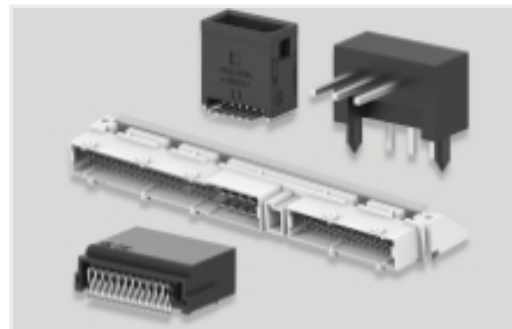

PCB Headers & Receptacles(533)

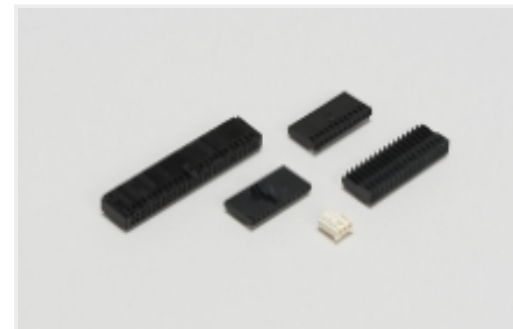

Wire-to-Board Connector Assemblies & Housings(305)

Customers Also Bought

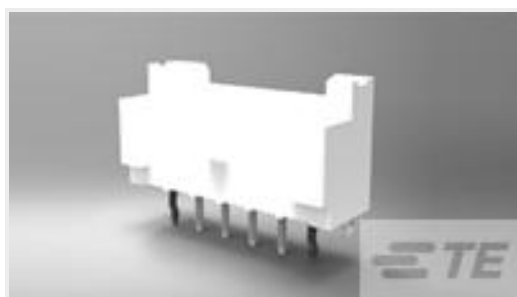

TE Part #2132415-2
EP2.5 Shrouded HDR ASSY 2P VERT w /o boss

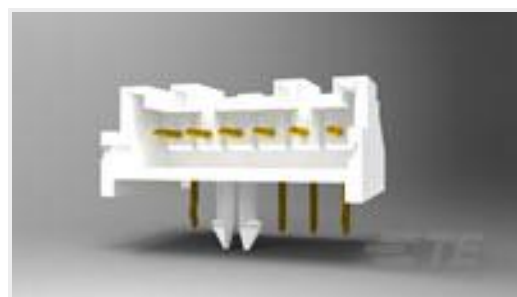

TE Part #1744426-9
Header Housing Assy, EP 2.5 RA, 9 Pos.



TE Part #1-1532185-9
M83513/03-G03C, MCKS-C2-B-51P6G9-18.0



TE Part #1532181-5
M83513/03-C09N, MCKS-N1-B-21P6Q1-18.0



TE Part #5796131-2
PWR TAP,6P,INSULATE,HGH TORQUE



TE Part #ABC20C-1331
RECP ASSY

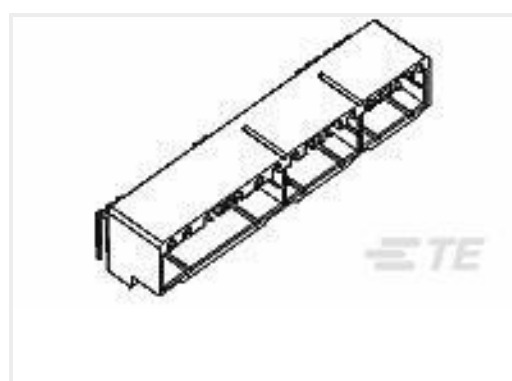

TE Part #175448-6
HYBRID I/O CAP ASSY 54P

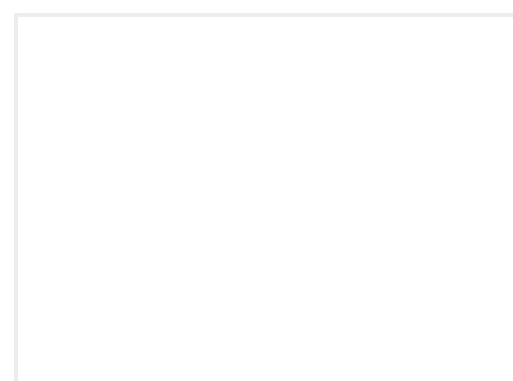

TE Part #YB81510F1655P1V0A1
RECP ASSY

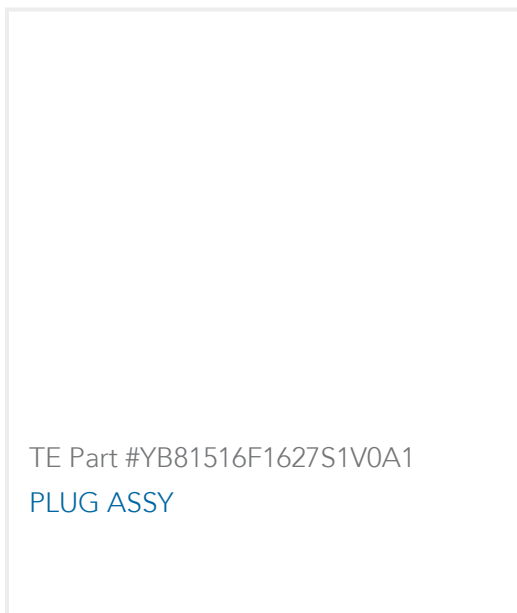

Documents

CAD Files

[3D PDF](#)

3D

Customer View Model

[ENG_CVM_CVM_2132415-9_G.2d_dxf.zip](#)

English

Customer View Model

[ENG_CVM_CVM_2132415-9_G.3d_igs.zip](#)

English

Customer View Model

[ENG_CVM_CVM_2132415-9_G.3d_stp.zip](#)

English

By downloading the CAD file I accept and agree to the [Terms and Conditions](#) of use.

Datasheets & Catalog Pages

[7-1773458-5_ECONOMY_POWER_QRG](#)

English

[7-1773461-6_EP2.5_Connector_Series](#)

English

Product Specifications

[Application Specification](#)

English

Agency Approvals

[VDE Certificate](#)

English