

776428-1 ✓ ACTIVE

AMP | AMPSEAL 16

TE Internal #: 776428-1

Cap, Wire-to-Wire, 2 Position, 4.5 mm [.177 in] Centerline, Sealable, Black, Wire & Cable, Cable Mount (Free-Hanging), AMPSEAL 16

[View on TE.com >](#)



Connectors > Automotive Connectors > Automotive Housings > AMPSEAL 16 Housings



Connector System: **Wire-to-Wire**

Number of Positions: **2**

Connector & Housing Type: **Cap**

Centerline (Pitch): **4.5 mm [.177 in]**

Sealable: **Yes**

[All AMPSEAL 16 Housings \(224\)](#)

Features

Product Type Features

Connector System	Wire-to-Wire
Connector & Housing Type	Cap
Sealable	Yes
Connector & Contact Terminates To	Wire & Cable
Primary Locking Feature	Integrated in Housing
Mixed & Hybrid Connector	No
Connector Shape	Rectangular

Configuration Features

Number of Positions	2
Number of Rows	1

Housing Features

Centerline (Pitch)	4.5 mm [.177 in]
Housing Material	PBT GF

Contact Features

Mating Pin Diameter	1.5 mm [.06 in]
Contact Size	1.5mm



Contact Type	Pin
--------------	-----

Body Features

Primary Product Color	Black
Connector & Keying Code	A
Cable Exit Angle	180°

Mechanical Attachment

Connector Mounting Type	Cable Mount (Free-Hanging)
Strain Relief	Add By Accessory
Terminal Position Assurance	Yes
Mating Alignment Type	Keyed
Mating Alignment	With

Usage Conditions

Operating Temperature (Max)	125 °C[257 °F]
Operating Temperature Range	-40 – 125 °C[-40 – 257 °F]

Other

Connector Position Assurance Capable	Yes
EU RoHS Compliance	Compliant
EU ELV Compliance	Compliant
Serviceable	Yes

Electrical Characteristics

Operating Voltage	250 VDC
-------------------	---------

Dimensions

Product Width	47.55 mm[1.872 in]
Product Length	19.6 mm[.772 in]
Connector Height	18.93 mm[.745 in]

Industry Standards

IP Rating	IP67
UL Flammability Rating	UL 94HB

Packaging Features

Packaging Quantity	1
Packaging Method	Package

Product Compliance

For compliance documentation, visit the product page on [TE.com](#)>

EU RoHS Directive 2011/65/EU	Compliant
EU ELV Directive 2000/53/EC	Compliant
China RoHS 2 Directive MIIT Order No 32, 2016	No Restricted Materials Above Threshold
EU REACH Regulation (EC) No. 1907/2006	<p>Current ECHA Candidate List: JUNE 2024 (241)</p> <p>Candidate List Declared Against: JUNE 2024 (241)</p> <p>SVHC > Threshold:</p> <p>Octamethylcyclotetrasiloxane (D4) (.5% in Component Part)</p> <p>Dodecamethylcyclohexasiloxane (D6) (.5% in Component Part)</p> <p>Decamethylcyclopentasiloxane (D5) (.5% in Component Part)</p> <p>Article Safe Usage Statements: Wash thoroughly after handling. Recycle if possible and dispose of the article by following all applicable governmental regulations relevant to your geographic location.</p>
Halogen Content	Low Halogen - Br, Cl, F, I < 900 ppm per homogenous material. Also BFR/CFR/PVC Free
Solder Process Capability	Not applicable for solder process capability

Product Compliance Disclaimer

This information is provided based on reasonable inquiry of our suppliers and represents our current actual knowledge based on the information they provided. This information is subject to change. The part numbers that TE has identified as EU RoHS compliant have a maximum concentration of 0.1% by weight in homogenous materials for lead, hexavalent chromium, mercury, PBB, PBDE, DBP, BBP, DEHP, DIBP, and 0.01% for cadmium, or qualify for an exemption to these limits as defined in the Annexes of Directive 2011/65/EU (RoHS2). Finished electrical and electronic equipment products will be CE marked as required by Directive 2011/65/EU. Components may not be CE marked. Additionally, the part numbers that TE has identified as EU ELV compliant have a maximum concentration of 0.1% by weight in homogenous materials for lead, hexavalent chromium, and mercury, and 0.01% for cadmium, or qualify for an exemption to these limits as defined in the Annexes of Directive 2000/53/EC (ELV). Regarding the REACH Regulation, the information TE provides on SVHC in articles for this part number is based on the latest European Chemicals Agency (ECHA) 'Guidance on requirements for substances in articles' posted at this URL: <https://echa.europa.eu/guidance-documents/guidance-on-reach>

Compatible Parts



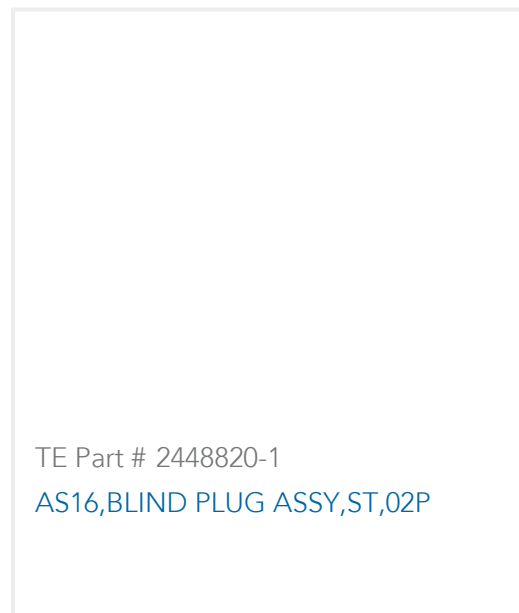

Also in the Series | **AMPSEAL 16**

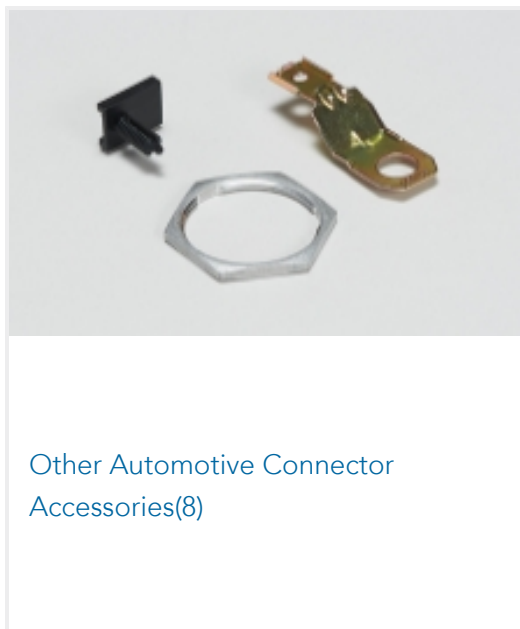
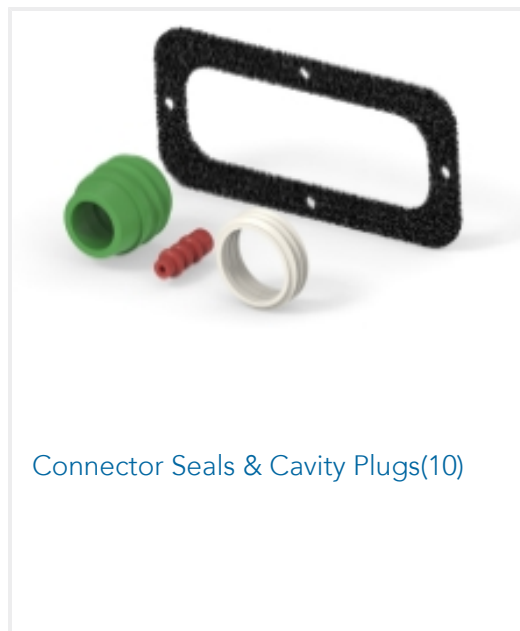
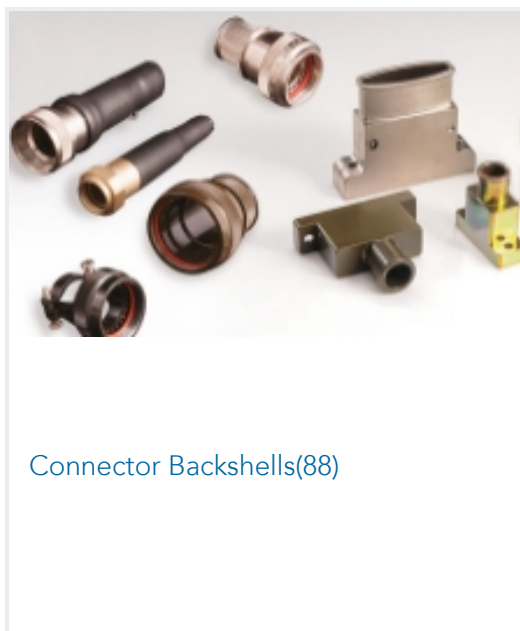
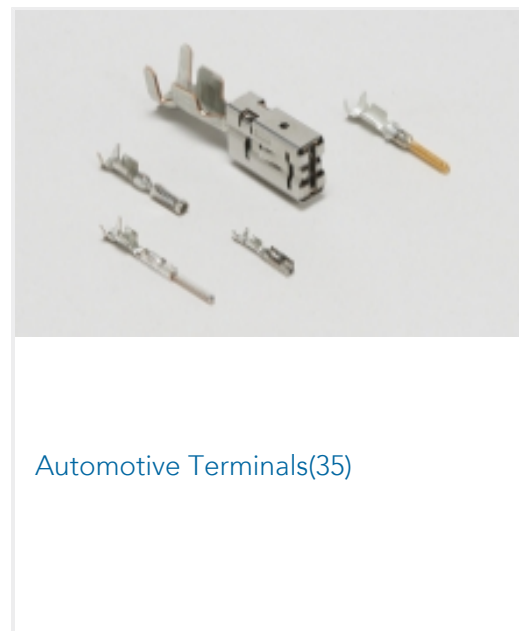
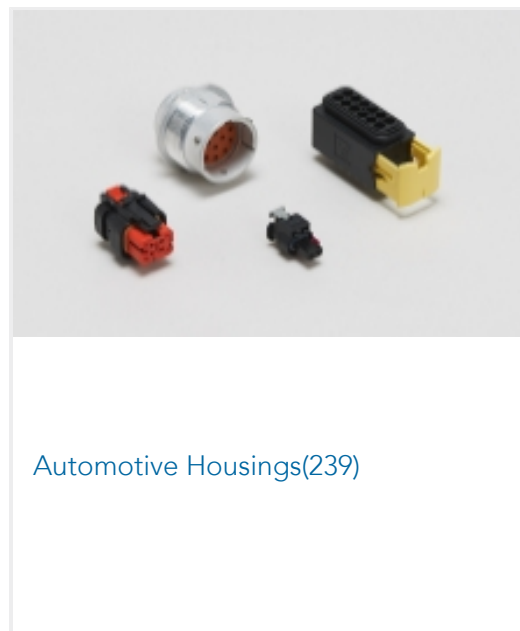
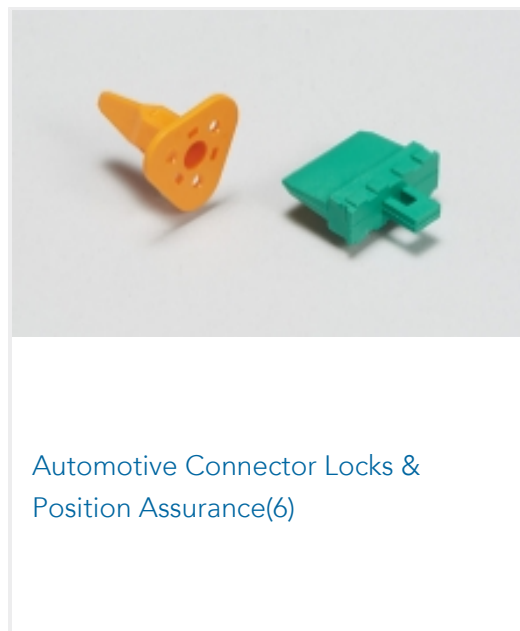
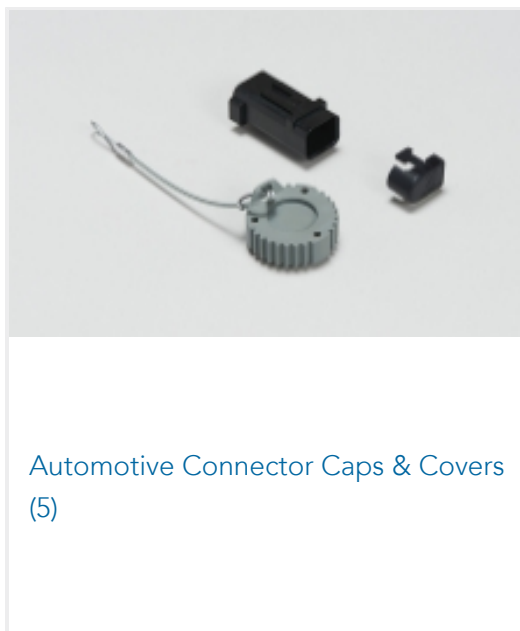

Customers Also Bought

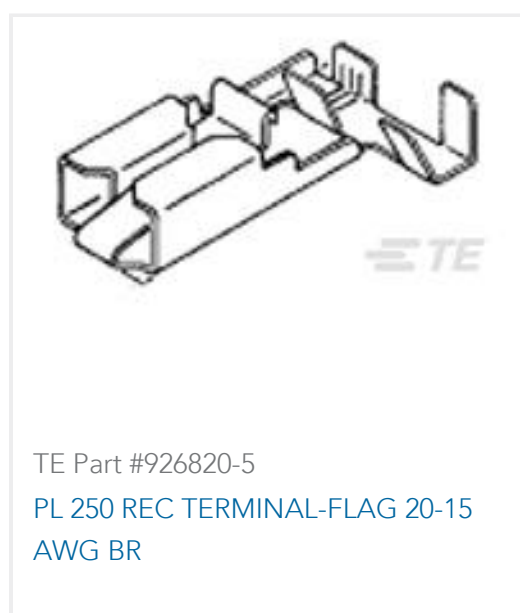



Documents

Product Drawings

[AS16,CAP ASSY,ST,02P,N SEAL,CODE A](#)

English

CAD Files

[3D PDF](#)

3D

Customer View Model

[ENG_CVM_CVM_776428-1_D_c-776428-1-d.2d_dxf.zip](#)

English

Customer View Model

[ENG_CVM_CVM_776428-1_D_c-776428-1-d.3d_igs.zip](#)

English

Customer View Model

[ENG_CVM_CVM_776428-1_D_c-776428-1-d.3d_stp.zip](#)

English

By downloading the CAD file I accept and agree to the [Terms and Conditions](#) of use.

Datasheets & Catalog Pages

[ICT Terminals and Connectors Catalogue](#)

English

[CONNECTOR SELECTOR](#)

English

Product Specifications

[Application Specification](#)

English

Instruction Sheets

[Instruction Sheet \(U.S.\)](#)

English