

60635-1 ✓ ACTIVE

FASTON | FASTON 250

TE Internal #: 60635-1

TE Internal Description: 250 FASTON REC 14-10 AWG TPBR

[View on TE.com >](#)

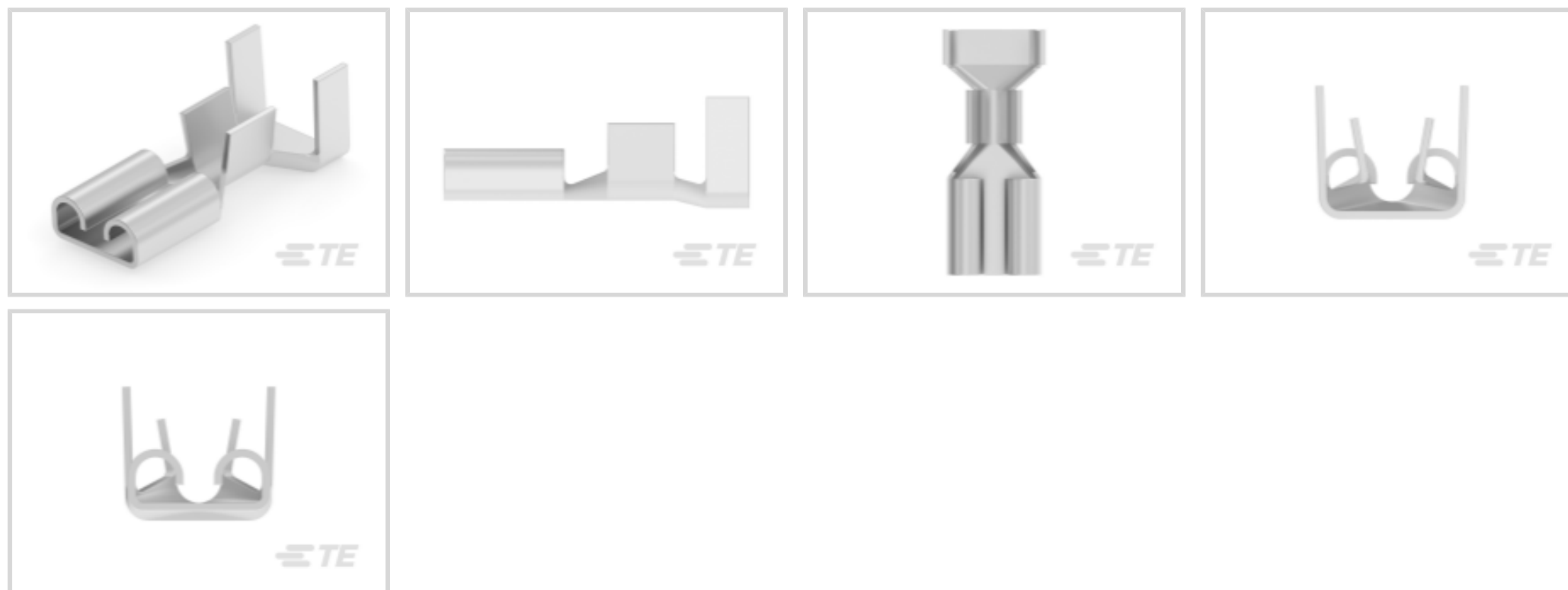

Product Compliance

[For compliance documentation, visit the product page on TE.com>](#)

EU RoHS Directive 2011/65/EU	Compliant
EU ELV Directive 2000/53/EC	Compliant
China RoHS 2 Directive MIIT Order No 32, 2016	No Restricted Materials Above Threshold
EU REACH Regulation (EC) No. 1907/2006	Current ECHA Candidate List: JUNE 2024 (241) Candidate List Declared Against: JUNE 2024 (241) Does not contain REACH SVHC
Halogen Content	Low Halogen - Br, Cl, F, I < 900 ppm per homogenous material. Also BFR/CFR/PVC Free
Solder Process Capability	Not applicable for solder process capability

Product Compliance Disclaimer

This information is provided based on reasonable inquiry of our suppliers and represents our current actual knowledge based on the information they provided. This information is subject to change. The part numbers that TE has identified as EU RoHS compliant have a maximum concentration of 0.1% by weight in homogenous materials for lead, hexavalent chromium, mercury, PBB, PBDE, DBP, BBP, DEHP, DIBP, and 0.01% for cadmium, or qualify for an exemption to these limits as defined in the Annexes of Directive 2011/65/EU (RoHS2). Finished electrical and electronic equipment products will be CE marked as required by Directive 2011/65/EU. Components may not be CE marked. Additionally, the part numbers that TE has identified as EU ELV compliant have a maximum concentration of 0.1% by weight in homogenous materials for lead, hexavalent chromium, and mercury, and 0.01% for cadmium, or qualify for an exemption to these limits as defined in the Annexes of Directive 2000/53/EC (ELV). Regarding the REACH Regulation, the information TE provides on SVHC in articles for this part number is based on the latest European Chemicals Agency (ECHA) 'Guidance on requirements for substances in articles' posted at this URL: <https://echa.europa.eu/guidance-documents/guidance-on-reach>

Compatible Parts



TE Part # 2376595-2
250 FASTON PCB TAB TPBR



TE Part # 2150056-2
OCEAN_2.0_APPLICATOR-E-140F310F-REA



TE Part # 7-2150056-7
OCEAN_2.0_SPARE_PART_KIT-140F310F

Also in the Series | **FASTON 250**

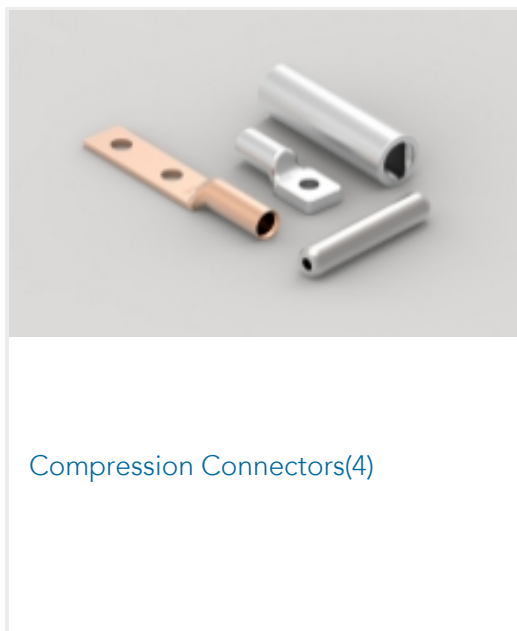

Compression Connectors(4)

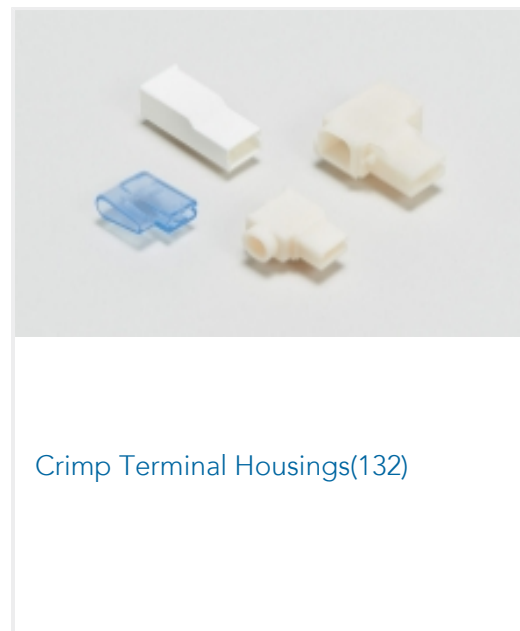

Crimp Terminal Housings(132)

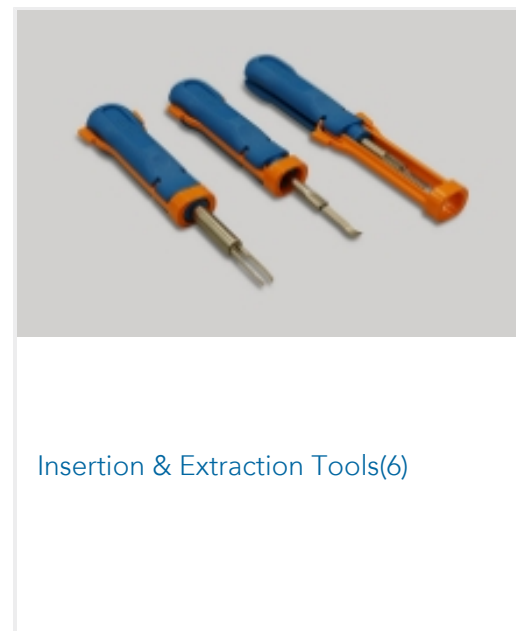

Insertion & Extraction Tools(6)



Magnet Wire Terminals(1)

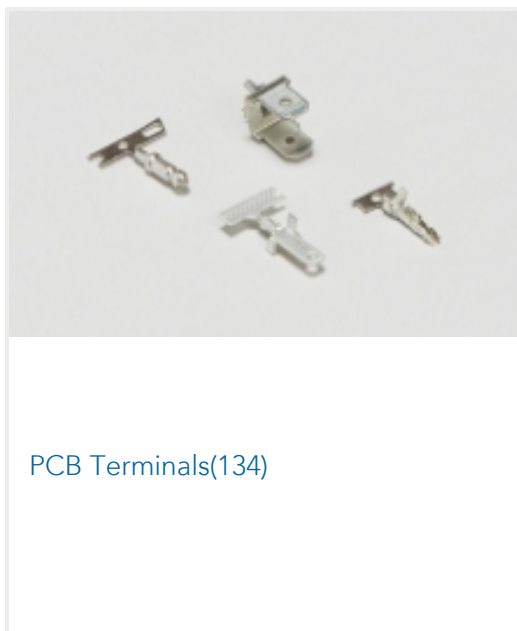

PCB Terminals(134)

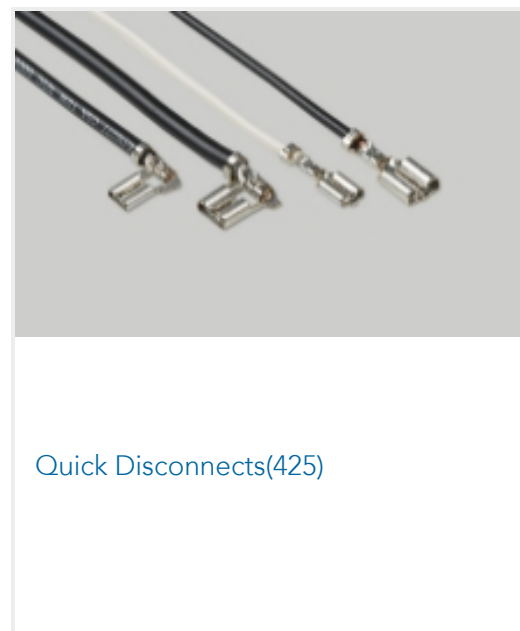

Quick Disconnects(425)



Splices(4)

Customers Also Bought



TE Part #794118-1
04P .156 MNL CAP PANEL MOUNT



TE Part #55678-2
TERM,PG RING 12-10 1/4



TE Part #63445-2
250 FASTON FLAG REC 18-12 AWG TPBR



TE Part #1-480416-1
FASTON 250 REC HSG 1CIR NYLON BLK

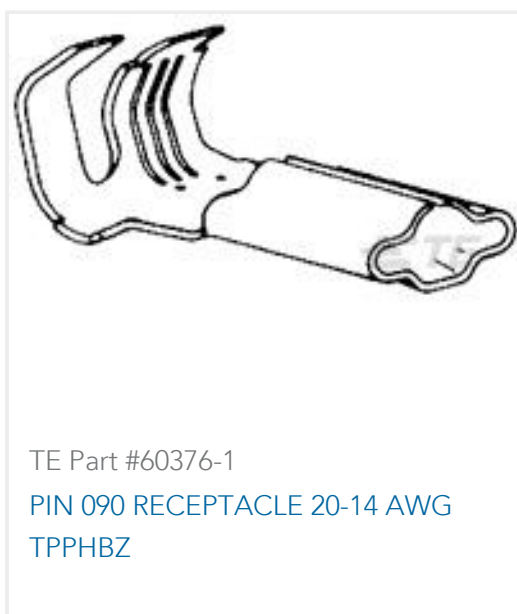

TE Part #60376-1
PIN 090 RECEPTACLE 20-14 AWG TPPHBZ



TE Part #1217918-1
250 FASTON,NICHROME TAB,20-15 AWG,NPST



TE Part #1742539-3
CLUSTER BLOCK RECEPT,TPCuFeP



TE Part #2119342-1
HOLDER, FEED FINGER



Documents

Product Drawings

[250 FASTON REC 14-10 AWG TPBR](#)

English

CAD Files

Customer View Model

[ENG_CVM_CVM_60635-1_AL.2d_dxf.zip](#)

English

[3D PDF](#)

3D

Customer View Model

[ENG_CVM_CVM_60635-1_AL.3d_igs.zip](#)

English

Customer View Model

[ENG_CVM_CVM_60635-1_AL.3d_stp.zip](#)

English

By downloading the CAD file I accept and agree to the [Terms and Conditions](#) of use.

Datasheets & Catalog Pages

[82004 FASTON Terminals \(Insulated and Uninsulated\) Catalog - FASTON Receptacles Section](#)

English

Product Specifications

[Engineering Report](#)

English

Agency Approvals

[UL Report](#)

English