

176285-6 ✓ ACTIVE

AMP Universal Power

TE Internal #: 176285-6

Housing, Receptacle, Wire-to-Wire, 6 Position, 3.96 mm [.156 in]

Centerline, Wire & Cable, UL 94V-0, AMP Universal Power,

Rectangular Power Connectors

[View on TE.com >](#)



Connectors > Power Connectors > Rectangular Power > Rectangular Power Connectors

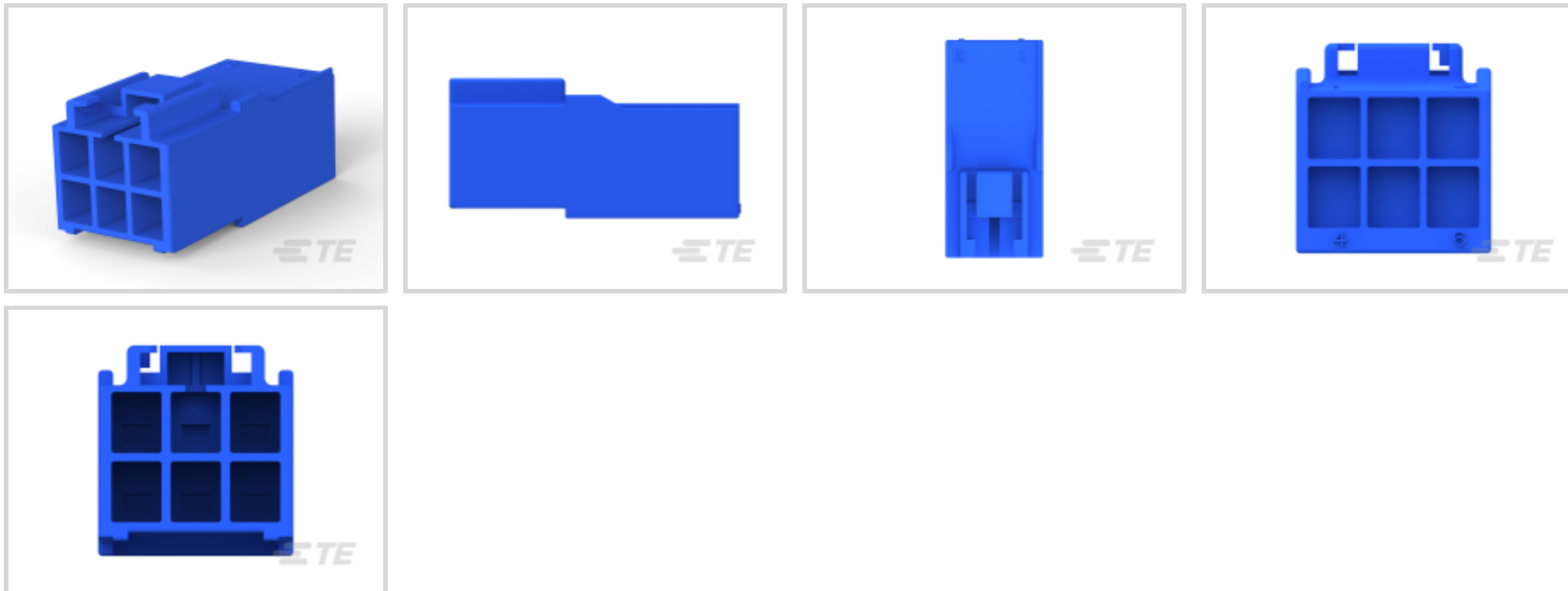

EU RoHS Compliance: **Compliant**

EU ELV Compliance: **Compliant**

Rectangular Power Connector Type: **Housing**

Connector & Housing Type: **Receptacle**

Connector System: **Wire-to-Wire**

### Features

#### Other

EU RoHS Compliance	Compliant
EU ELV Compliance	Compliant

#### Product Type Features

Rectangular Power Connector Type	Housing
Connector & Housing Type	Receptacle
Connector System	Wire-to-Wire
Sealable	No
Connector & Contact Terminates To	Wire & Cable

#### Configuration Features

Number of Positions	6
Number of Power Positions	0
Number of Signal Positions	0
Number of Rows	2

#### Electrical Characteristics



Insulation Resistance	1000 MΩ
Operating Voltage	300 VAC

### Contact Features

Contact Layout	Matrix
Contact Base Material	Copper Alloy
Contact Current Rating (Max)	7 A
Contact Retention Within Housing	Without
Contact Type	Tab

### Termination Features

Termination Method to Wire & Cable	Crimp
------------------------------------	-------

### Mechanical Attachment

Strain Relief	Without
Panel Mount Feature	Without
Mating Retention Type	Latch
PCB Mount Retention	With
Mating Retention	With
Mating Alignment Type	Polarization
Mating Alignment	With
Connector Mounting Type	Cable Mount (Free-Hanging)

### Housing Features

Centerline (Pitch)	3.96 mm [.156 in]
Housing Color	Blue
Housing Material	Nylon 6/6

### Dimensions

Product Length	29 mm [1.14 in]
Connector Height	13 mm [.51 in]
Row-to-Row Spacing	4.6 mm [.181 in]

### Usage Conditions

Operating Temperature Range	-30 – 105 °C [-22 – 221 °F]
-----------------------------	-----------------------------

### Operation/Application

Circuit Application	Power & Signal
---------------------	----------------



### Industry Standards

UL Flammability Rating	UL 94V-0
Glow Wire Rating	Standard Part - Not Glow Wire

### Packaging Features

Packaging Quantity	500
Packaging Method	Bag

### Product Compliance

[For compliance documentation, visit the product page on TE.com>](#)











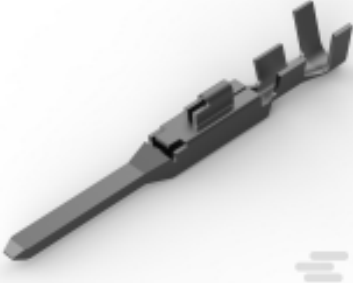

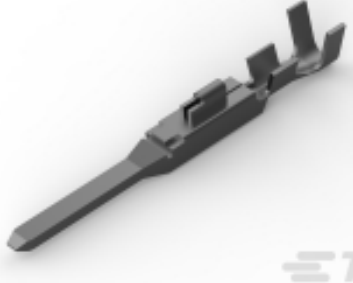
EU RoHS Directive 2011/65/EU	Compliant
EU ELV Directive 2000/53/EC	Compliant
China RoHS 2 Directive MIIT Order No 32, 2016	No Restricted Materials Above Threshold
EU REACH Regulation (EC) No. 1907/2006	Current ECHA Candidate List: JUNE 2024 (241) Candidate List Declared Against: JUNE 2024 (241) Does not contain REACH SVHC
Halogen Content	Low Halogen - Br, Cl, F, I < 900 ppm per homogenous material. Also BFR/CFR/PVC Free
Solder Process Capability	Not applicable for solder process capability

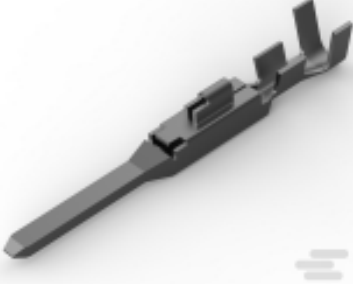
#### Product Compliance Disclaimer

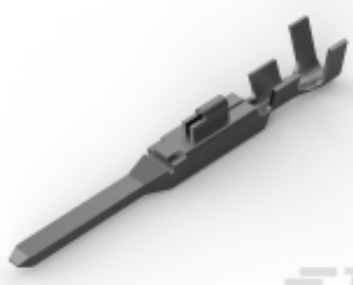
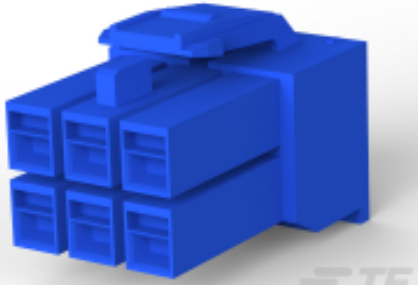

This information is provided based on reasonable inquiry of our suppliers and represents our current actual knowledge based on the information they provided. This information is subject to change. The part numbers that TE has identified as EU RoHS compliant have a maximum concentration of 0.1% by weight in homogenous materials for lead, hexavalent chromium, mercury, PBB, PBDE, DBP, BBP, DEHP, DIBP, and 0.01% for cadmium, or qualify for an exemption to these limits as defined in the Annexes of Directive 2011/65/EU (RoHS2). Finished electrical and electronic equipment products will be CE marked as required by Directive 2011/65/EU. Components may not be CE marked. Additionally, the part numbers that TE has identified as EU ELV compliant have a maximum concentration of 0.1% by weight in homogenous materials for lead, hexavalent chromium, and mercury, and 0.01% for cadmium, or qualify for an exemption to these limits as defined in the Annexes of Directive 2000/53/EC (ELV). Regarding the REACH Regulation, the information TE provides on SVHC in articles for this part number is based on the latest European Chemicals Agency (ECHA) 'Guidance on requirements for substances in articles' posted at this URL: <https://echa.europa.eu/guidance-documents/guidance-on-reach>

### Compatible Parts



 <p>TE Part # 175153-1 UNIV POWER TAB CONT L/P</p>	 <p>TE Part # 175150-1 UNIVERSAL POWER CONN TAB</p>	 <p>TE Part # 175149-2 AMP UNIVE. POWER CONN TAB CONT</p>	 <p>TE Part # 175150-2 AMP UNIVE. POWER CONN TAB CONT</p>
 <p>TE Part # 175153-2 U/P TAB CONT L/P</p>	 <p>TE Part # 175154-1 UNIV POWER TAB CONT L/P</p>	 <p>TE Part # 176274-1 AMP UNIVERSAL POWER PLUG 6P</p>	 <p>TE Part # 175154-2 U/P TAB CONT L/P</p>
 <p>TE Part # 176274-2 AMP UNIVERSAL POWER PLUG 6P</p>	 <p>TE Part # 175149-1 UNIVERSAL POWER CONN TAB</p>	 <p>TE Part # 176274-6 AMP UNIVERSAL POWER PLUG 6P</p>	 <p>TE Part # 176274-4 AMP UNIVERSAL POWER PLUG 6P</p>
 <p>TE Part # 175149-3 AMP UNIVERSAL POWER CONN.TAB C</p>	 <p>TE Part # 176274-9 AMP UNIVERSAL POWER PLUG 6P</p>		

Also in the Series | **AMP Universal Power**

 <p>Connector Contacts(22)</p>	 <p>Insertion &amp; Extraction Tools(1)</p>	 <p>PCB Headers &amp; Receptacles(51)</p>	 <p>Rectangular Power Connectors(112)</p>
---	--	--	--

Customers Also Bought

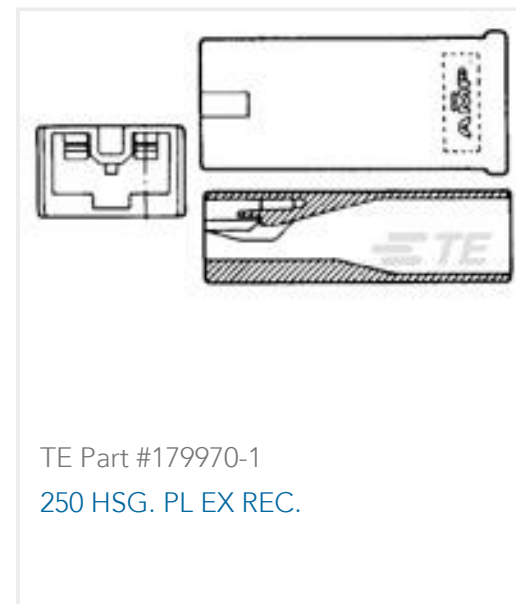
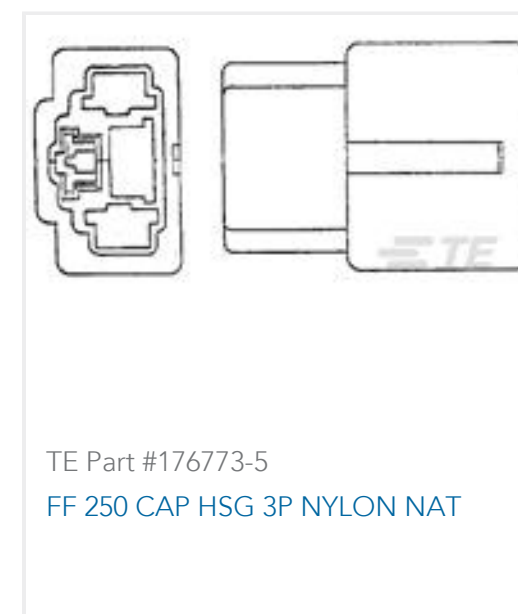

## Documents

### Product Drawings

[AMP UNIVERSAL POWER CAP 6P](#)

English

### CAD Files

[3D PDF](#)

3D

[Customer View Model](#)

[ENG\\_CVM\\_CVM\\_176285-6\\_G\\_c-176285-6-g.2d\\_dxf.zip](#)

English

[Customer View Model](#)

[ENG\\_CVM\\_CVM\\_176285-6\\_G\\_c-176285-6-g.3d\\_igs.zip](#)

English

[Customer View Model](#)

[ENG\\_CVM\\_CVM\\_176285-6\\_G\\_c-176285-6-g.3d\\_stp.zip](#)

English

By downloading the CAD file I accept and agree to the [Terms and Conditions](#) of use.

### Product Specifications



### [Crimping of Universal Power Contact](#)

English

### [Product Specification](#)

Japanese

### [AMP Universal Power Connector](#)

Japanese

---

### [Instruction Sheets](#)

#### [AMP UNIVERSAL POWER CONNECTOR SERIES](#)

English

#### [Instruction Sheet \(non U.S.\)](#)

English

---

### [Agency Approvals](#)

#### [UL Report](#)

English