

# 2MM-R-S04-VT-01-H-TBP ✓ ACTIVE

AMPMODU | AMPMODU 2 mm

TE Internal #: 2314870-4

PCB Mount Receptacle, Vertical, Board-to-Board, 4 Position, 2 mm [.079 in] Centerline, Gold, Through Hole - Solder, Signal, Black, Tube, AMPMODU 2 mm

[View on TE.com >](#)



Connectors > PCB Connectors > PCB Headers & Receptacles

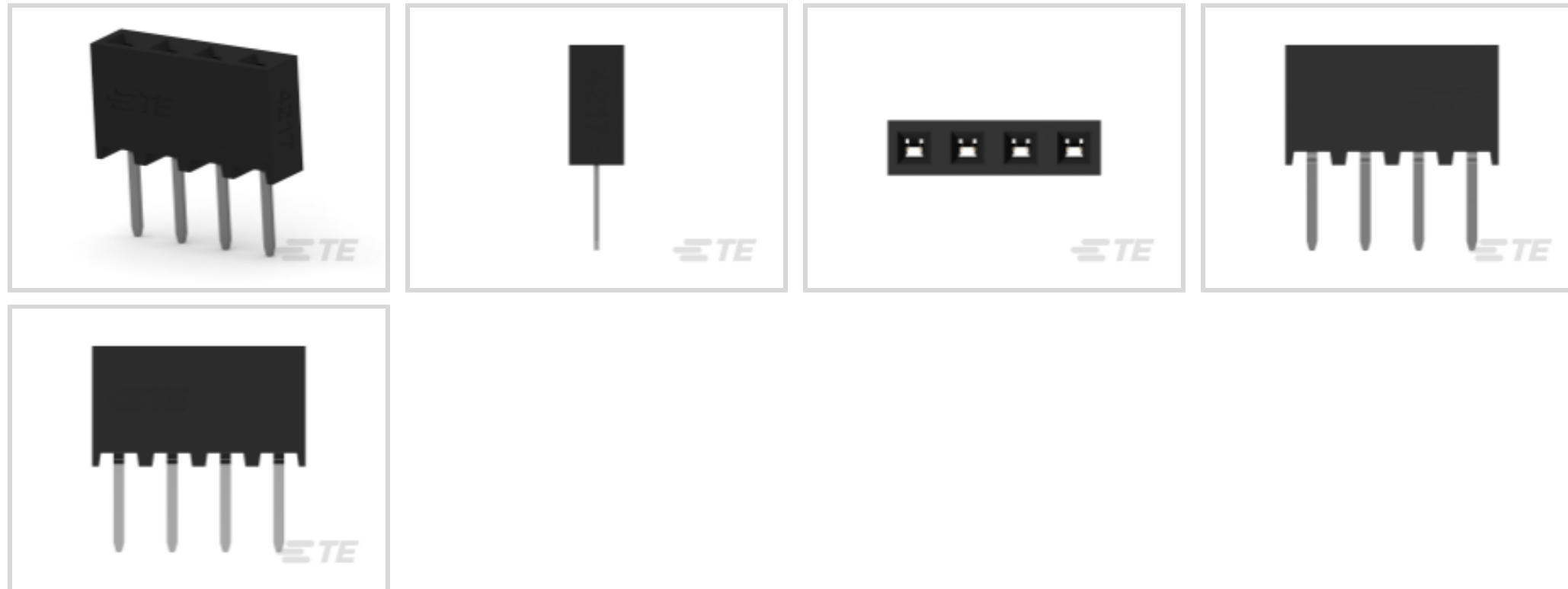

EU RoHS Compliance: **Compliant**

EU ELV Compliance: **Compliant**

PCB Connector Assembly Type: **PCB Mount Receptacle**

PCB Mount Orientation: **Vertical**

Connector System: **Board-to-Board**

## Features

### Other

EU RoHS Compliance	Compliant
EU ELV Compliance	Compliant

### Product Type Features

PCB Connector Assembly Type	PCB Mount Receptacle
Connector System	Board-to-Board
Connector & Contact Terminates To	Printed Circuit Board

### Configuration Features

Number of Loaded Positions	4
PCB Mount Orientation	Vertical
Number of Positions	4
Number of Rows	1

### Electrical Characteristics

Operating Voltage	125 VAC
Dielectric Withstanding Voltage (Max)	650 VAC



### Body Features

Connector Profile	Standard
Primary Product Color	Black

### Contact Features

Contact Underplating Material	Nickel
Contact Underplating Material Thickness	1.27 $\mu\text{m}$ [50 $\mu\text{in}$ ]
PCB Contact Termination Area Plating Material Finish	Matte
Contact Mating Area Plating Material Thickness	.76 $\mu\text{m}$ [29.9212 $\mu\text{in}$ ]
Mating Square Post Dimension	.5 mm[.02 in]
PCB Contact Termination Area Plating Material Thickness	3 – 5 $\mu\text{m}$ [118.11 – 196.85 $\mu\text{in}$ ]
Contact Layout	Inline
Contact Base Material	Phosphor Bronze
PCB Contact Termination Area Plating Material	Tin
Contact Mating Area Plating Material Finish	Matte
Contact Mating Area Plating Material	Gold
Contact Type	Socket
Contact Current Rating (Max)	2 A

### Termination Features

Rectangular Termination Post & Tail Width	.4 mm[.016 in]
Rectangular Termination Post & Tail Thickness	.2 mm[.008 in]
Termination Post & Tail Length	2 mm[.079 in]
Termination Method to PCB	Through Hole - Solder

### Mechanical Attachment

PCB Mount Retention	Without
PCB Mount Alignment	Without
Connector Mounting Type	Board Mount
Mating Alignment	Without

### Housing Features

Housing Material	LCP (Liquid Crystal Polymer)
Centerline (Pitch)	2 mm[.079 in]

### Dimensions

Connector Width	2 mm[.079 in]
-----------------	---------------



PCB Thickness (Recommended)	1.6 mm[.063 in]
-----------------------------	-----------------

Connector Height	4.5 mm[.18 in]
------------------	----------------

Connector Length	8 mm[.315 in]
------------------	---------------

### Usage Conditions

Housing Temperature Rating	High
----------------------------	------

Operating Temperature Range	-40 – 125 °C[-40 – 257 °F]
-----------------------------	----------------------------

### Operation/Application

Assembly Process Feature	Pick and Place Cover
--------------------------	----------------------

Circuit Application	Signal
---------------------	--------

### Industry Standards

UL Flammability Rating	UL 94V-0
------------------------	----------

### Packaging Features

Packaging Method	Tube
------------------	------

## Product Compliance

[For compliance documentation, visit the product page on TE.com>](#)

EU RoHS Directive 2011/65/EU	Compliant
------------------------------	-----------

EU ELV Directive 2000/53/EC	Compliant
-----------------------------	-----------

China RoHS 2 Directive MIIT Order No 32, 2016	No Restricted Materials Above Threshold
---	---

EU REACH Regulation (EC) No. 1907/2006	Current ECHA Candidate List: JUNE 2024 (241) Candidate List Declared Against: JUNE 2024 (241) Does not contain REACH SVHC
--	---

Halogen Content	Low Halogen - Br, Cl, F, I < 900 ppm per homogenous material. Also BFR/CFR/PVC Free
-----------------	---

Solder Process Capability	Reflow solder capable to 260°C
---------------------------	--------------------------------

#### Product Compliance Disclaimer

This information is provided based on reasonable inquiry of our suppliers and represents our current actual knowledge based on the information they provided. This information is subject to change. The part numbers that TE has identified as EU RoHS compliant have a maximum concentration of 0.1% by weight in homogenous materials for lead, hexavalent chromium, mercury, PBB, PBDE, DBP, BBP, DEHP, DIBP, and 0.01% for cadmium, or qualify for an exemption to these limits as defined in the Annexes of Directive 2011/65/EU (RoHS2). Finished electrical and electronic equipment products will be CE marked as required by Directive 2011/65/EU. Components may not be CE marked. Additionally, the part numbers that TE has identified as EU ELV compliant have a maximum concentration of 0.1% by weight in homogenous materials for lead, hexavalent chromium, and mercury, and 0.01% for cadmium, or qualify for an exemption to these limits as defined in the Annexes of Directive 2000/53/EC (ELV). Regarding the REACH Regulation, the information TE provides on SVHC in articles for this part number is based on the latest European Chemicals Agency (ECHA) 'Guidance on

requirements for substances in articles' posted at this URL: <https://echa.europa.eu/guidance-documents/guidance-on-reach>

## Compatible Parts

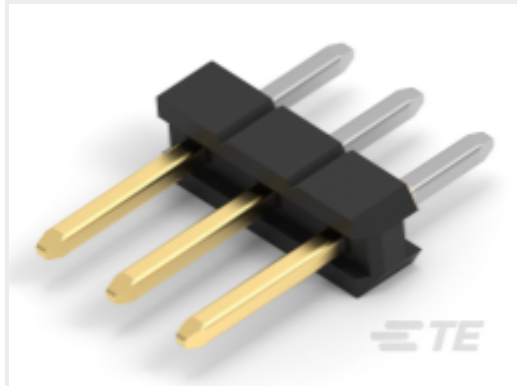

TE Part # 2355182-4  
4P,2MM,BRK HDR,SRVT,2.8,0.76AU,TB

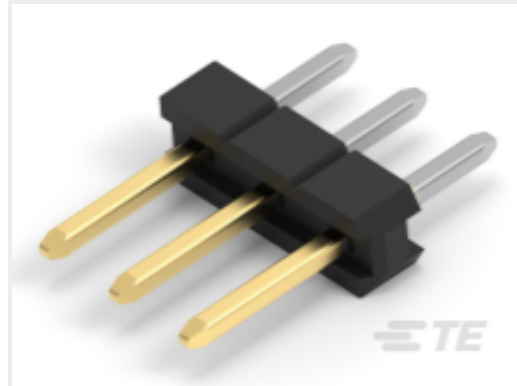

TE Part # 2355184-4  
4P,2MM,BRK HDR,SRVT,2.8,0.76AU,TB W/CAP

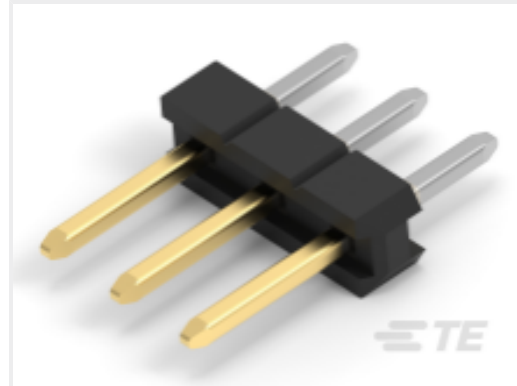

TE Part # 2355186-4  
4P,2MM,BRK HDR,SRVT,2.8,0.76AU, BOX



TE Part # 2842104-4  
4P,2MM,BRK HDR,SRVT,SMD,0.76AU, TR W/CAP



TE Part # 2842112-4  
4P,2MM,BRK HDR,SRRT,2.8,0.76AU,TB



TE Part # 2842116-4  
4P,2MM,BRK HDR,SRRT,2.8,0.76AU,TB W/CAP



TE Part # 2842124-4  
4P,2MM,BRK HDR,SRRT,2.8,0.76AU, BOX

## Also in the Series | AMPMODU 2 mm



Connector Contacts(27)

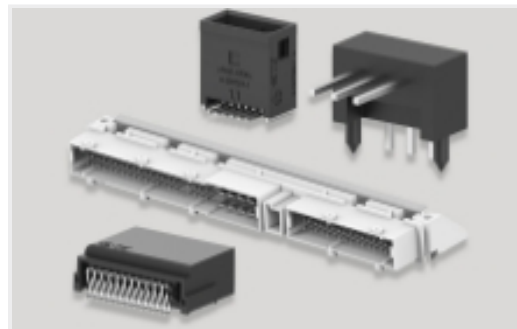

PCB Headers & Receptacles(8190)



Wire-to-Board Connector Assemblies & Housings(202)

## Customers Also Bought



TE Part #2-332004-0  
SMA JAM NUT, PASSIVATED



TE Part #5520258-2  
MJ,TE,6P/4C,PNL STOPS,TRAY P

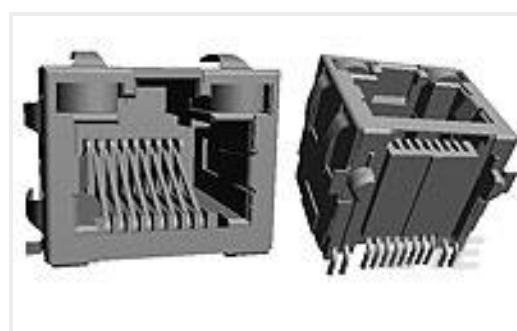

TE Part #6339160-1  
MJ,RJ45,SMT,SHLD,PANEL GRD

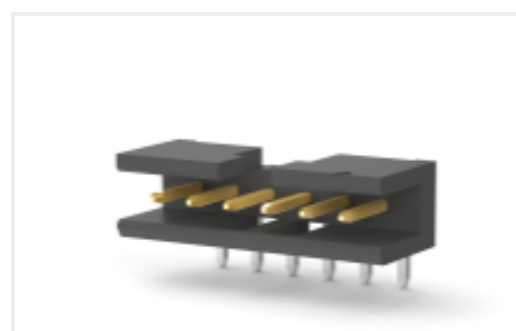

TE Part #2823394-4  
4P,2MM,SHRD HDR,SRRT,2.8,0.76AU, TB

## Documents

### Product Drawings

4P,2MM,BB,REC,SRVT,2.0,0.76AU,TB,W/CP



English

---

**CAD Files**

**3D PDF**

3D

**Customer View Model**

[ENG\\_CVM\\_CVM\\_2314870-4\\_A.2d\\_dxf.zip](#)

English

**Customer View Model**

[ENG\\_CVM\\_CVM\\_2314870-4\\_A.3d\\_igs.zip](#)

English

**Customer View Model**

[ENG\\_CVM\\_CVM\\_2314870-4\\_A.3d\\_stp.zip](#)

English

By downloading the CAD file I accept and agree to the [Terms and Conditions](#) of use.

---

**Datasheets & Catalog Pages**

[AMPMODU 2mm BOARD-TO-BOARD RECEPTACLES](#)

English

[AMPMODU 2mm interconnection system QRG](#)

English

---

**Product Specifications**

[Application Specification](#)

English