

350430-4 ✓ ACTIVE

MATE-N-LOK | Universal MATE-N-LOK

TE Internal #: 350430-4

PCB Mount Header, Vertical, Wire-to-Board, 4 Position, 6.35 mm [.25 in] Centerline, Fully Shrouded, Gold, Through Hole - Solder, Universal MATE-N-LOK

[View on TE.com >](#)



Connectors > PCB Connectors > PCB Headers & Receptacles

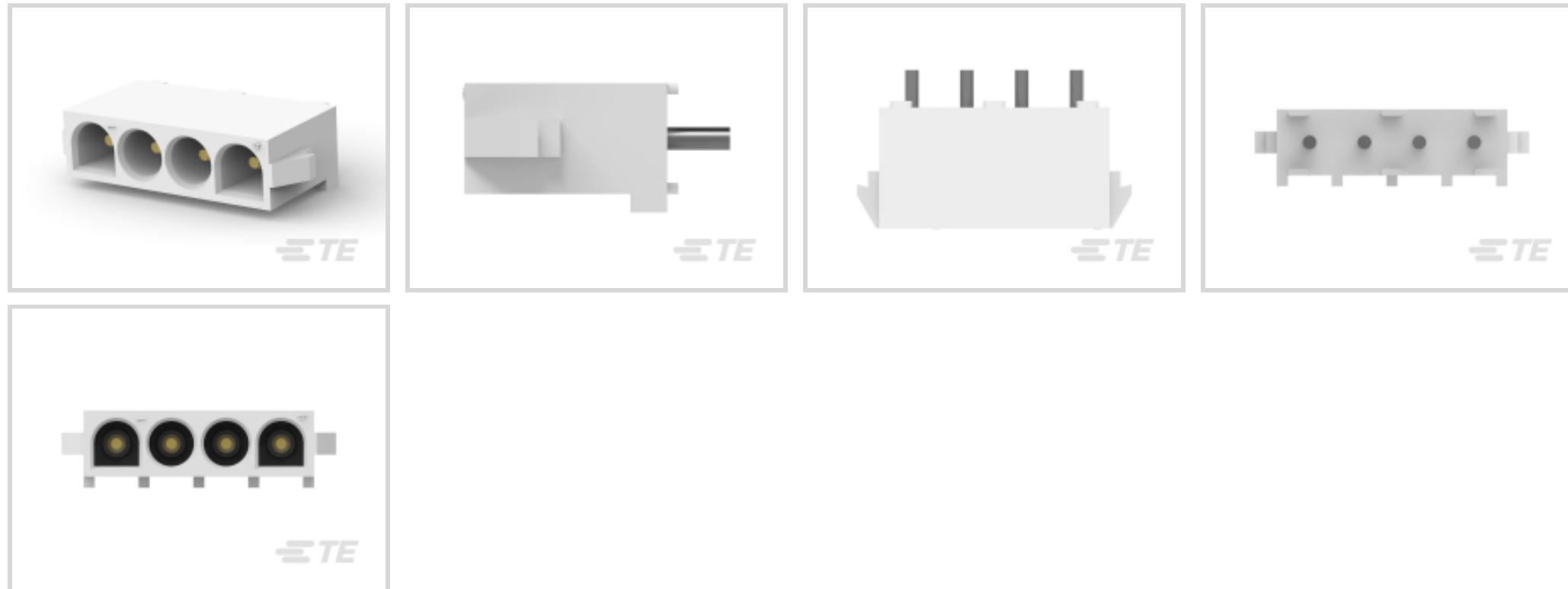

EU RoHS Compliance: **Compliant**

EU ELV Compliance: **Compliant**

PCB Connector Assembly Type: **PCB Mount Header**

PCB Mount Orientation: **Vertical**

Connector System: **Wire-to-Board**

Features

Other

EU RoHS Compliance	Compliant
EU ELV Compliance	Compliant

Product Type Features

Mixed & Hybrid Header	No
Connector Shape	Rectangular
PCB Connector Assembly Type	PCB Mount Header
Connector System	Wire-to-Board
Header Type	Fully Shrouded
Sealable	No
Connector & Contact Terminates To	Printed Circuit Board

Configuration Features

Number of Columns	4
Number of Loaded Positions	4
Number of Power Positions	4



Connector Contact Load Condition	Fully Loaded
PCB Mount Orientation	Vertical
Number of Positions	4
Number of Rows	1

Electrical Characteristics

Operating Voltage	600 VAC
-------------------	---------

Body Features

Primary Product Color	Natural
-----------------------	---------

Contact Features

Contact Underplating Material	Nickel
Mating Pin Diameter	2.2 mm[.087 in]
Contact Underplating Material Thickness	1.27 – 1.79 μm [50 – 70 μin]
PCB Contact Termination Area Plating Material Finish	Matte
Contact Size	2.2mm
Contact Mating Area Plating Material Thickness	.76 – .91 μm [30 – 36 μin]
PCB Contact Termination Area Plating Material Thickness	3.81 – 5.08 μm [150 – 200 μin]
Contact Shape & Form	Round
Contact Layout	Inline
Contact Base Material	Phosphor Bronze
PCB Contact Termination Area Plating Material	Tin
Contact Mating Area Plating Material	Gold
Contact Type	Pin
Contact Current Rating (Max)	12 A

Termination Features

Termination Post & Tail Diameter	1.57 mm[.062 in]
Termination Post & Tail Length	3.56 mm[.14 in]
Termination Method to PCB	Through Hole - Solder

Mechanical Attachment

Panel Mount Feature	Without
Mating Retention Type	Locking Tab
Mating Retention	With
Mating Alignment Type	Polarization



PCB Mount Retention	Without
PCB Mount Alignment	Without
Connector Mounting Type	Board Mount
Mating Alignment	With

Housing Features

Mating Entry Location	Top
Housing Material	Nylon
Centerline (Pitch)	6.35 mm [.25 in]

Dimensions

Connector Width	7.62 mm [.3 in]
PCB Thickness (Recommended)	1.57 mm [.062 in]
Connector Height	13.97 mm [.55 in]
Connector Length	26.67 mm [1.05 in]
Profile Height from PCB	14.73 mm [.58 in]

Usage Conditions

Operating Temperature (Max)	105 °C [221 °F]
Operating Temperature Range	-40 – 105 °C [-40 – 221 °F]

Operation/Application

Circuit Application	Power
---------------------	-------

Industry Standards

Compatible With Agency/Standards Products	UL, VDE, CSA
UL Rating	Recognized
Compatible With Approved Standards Products	UL E28476
Glow Wire Rating	Standard Part - Not Glow Wire
UL Flammability Rating	UL 94V-2

Packaging Features

Packaging Quantity	100
Packaging Method	Bag

Product Compliance

[For compliance documentation, visit the product page on TE.com>](#)

EU RoHS Directive 2011/65/EU	Compliant
------------------------------	-----------









EU ELV Directive 2000/53/EC	Compliant
China RoHS 2 Directive MIIT Order No 32, 2016	No Restricted Materials Above Threshold
EU REACH Regulation (EC) No. 1907/2006	Current ECHA Candidate List: JUNE 2024 (241) Candidate List Declared Against: JUNE 2024 (241) Does not contain REACH SVHC
Halogen Content	Low Halogen - Br, Cl, F, I < 900 ppm per homogenous material. Also BFR/CFR/PVC Free
Solder Process Capability	Wave solder capable to 265°C

Product Compliance Disclaimer

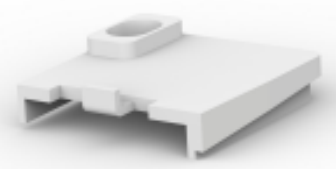
This information is provided based on reasonable inquiry of our suppliers and represents our current actual knowledge based on the information they provided. This information is subject to change. The part numbers that TE has identified as EU RoHS compliant have a maximum concentration of 0.1% by weight in homogenous materials for lead, hexavalent chromium, mercury, PBB, PBDE, DBP, BBP, DEHP, DIBP, and 0.01% for cadmium, or qualify for an exemption to these limits as defined in the Annexes of Directive 2011/65/EU (RoHS2). Finished electrical and electronic equipment products will be CE marked as required by Directive 2011/65/EU. Components may not be CE marked. Additionally, the part numbers that TE has identified as EU ELV compliant have a maximum concentration of 0.1% by weight in homogenous materials for lead, hexavalent chromium, and mercury, and 0.01% for cadmium, or qualify for an exemption to these limits as defined in the Annexes of Directive 2000/53/EC (ELV). Regarding the REACH Regulation, the information TE provides on SVHC in articles for this part number is based on the latest European Chemicals Agency (ECHA) 'Guidance on requirements for substances in articles' posted at this URL: <https://echa.europa.eu/guidance-documents/guidance-on-reach>

Compatible Parts

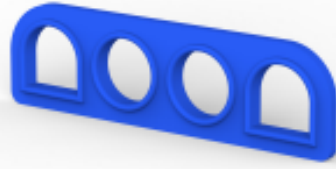
 <p>TE Part # 641776-1 04P UMNL STR/REL</p>	 <p>TE Part # 1-350589-0 STR/REL CLAMP NATL</p>	 <p>TE Part # 350811-1 STR/REL CLAMP</p>	 <p>TE Part # 641775-1 04P UMNL STR/REL & INSRT NATL</p>
 <p>TE Part # 1586845-1 04P UMNL CAP HSG NATL, GW</p>	 <p>TE Part # 770351-1 04P UMNL PIN HDR ASSY W/O DRNS</p>	 <p>TE Part # 641968-3 04P UMNL PIN HDR ASSY POL 94VO</p>	 <p>TE Part # 794273-1 04P UMNL INTERFACE SEAL</p>



Also in the Series | **Universal MATE-N-LOK**

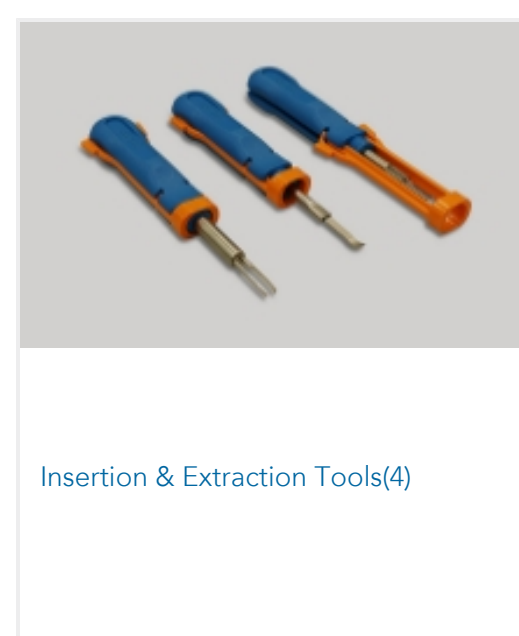
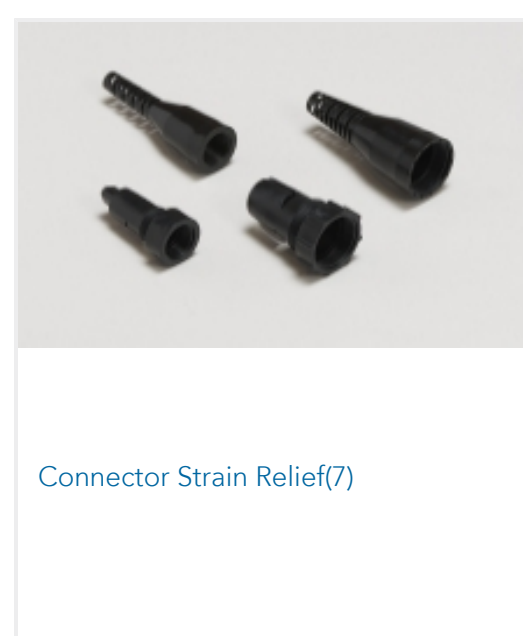
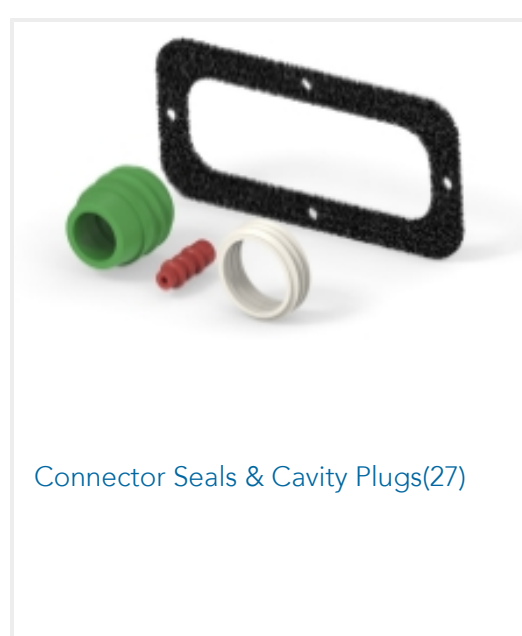
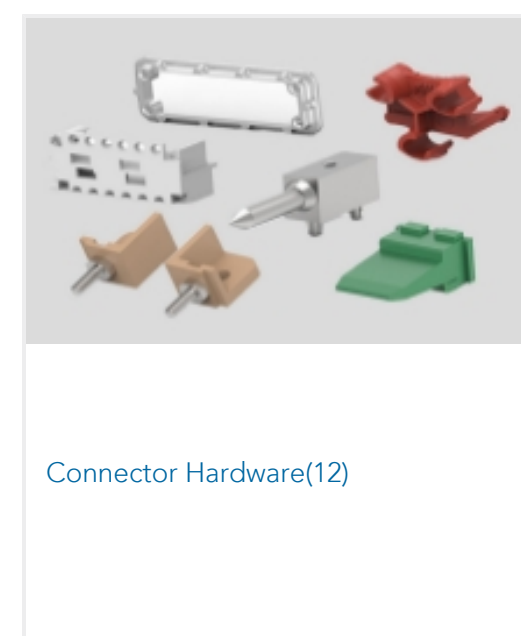
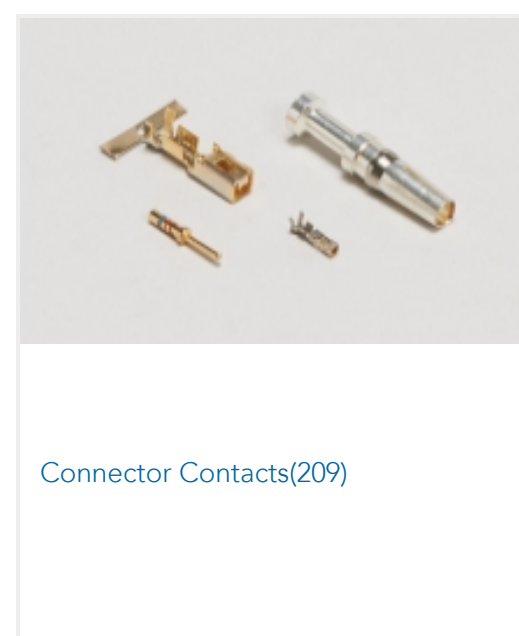
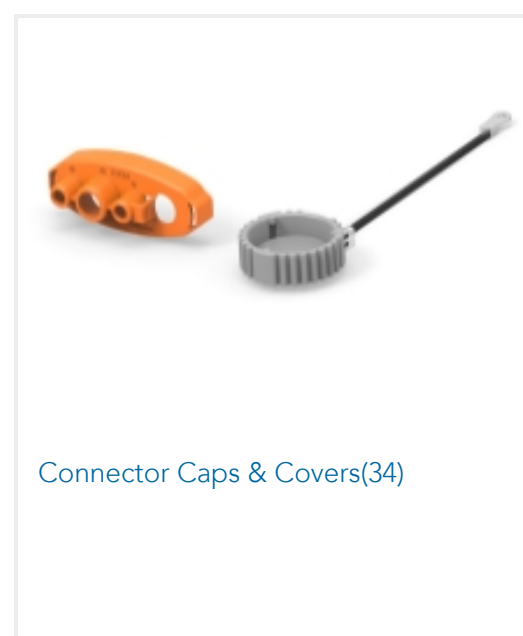
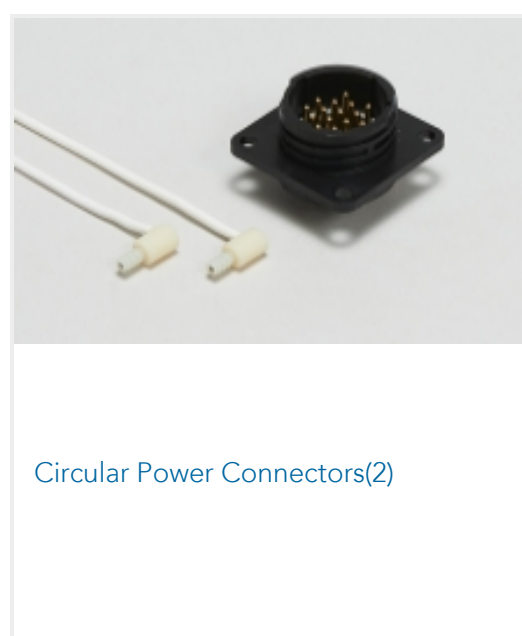



Rectangular Connector Housings(1)



Rectangular Power Connectors(370)



Standard Circular Connectors(1)

Customers Also Bought

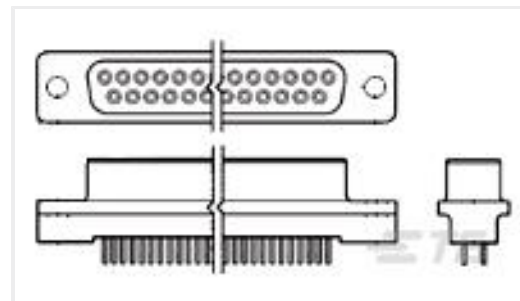
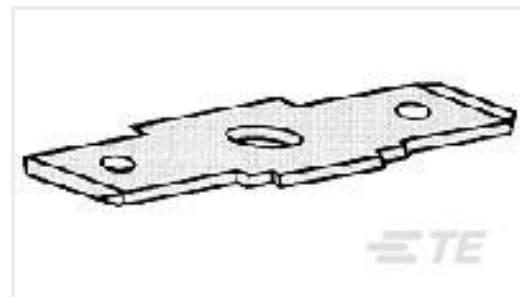
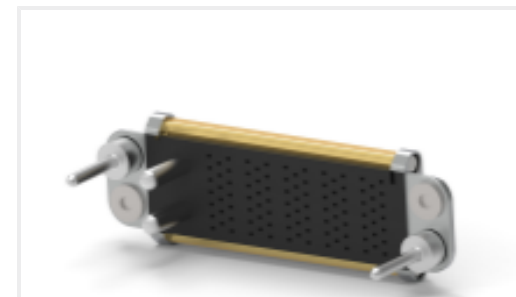
TE Part #35363
TERMINAL,PIDG R 16-14HD 10TE Part #5745080-4
HD-20 RCPT 50P VERT FFSCRLKTE Part #770262-3
06P UMNL SOK HDR ASSY 94VO LFTE Part #1-87227-0
20 MODII HDR DRST UNSHRD .100TE Part #34824
TERMINAL,PG R 16-14HD 1/4TE Part #62627-1
250 FASTON TAB TPSTTE Part #3-1618239-2
K41B234=RELAY, VACUUM, SPST-NCTE Part #2085359-1
CONNECTOR,PIN,DOMINO

Documents

Product Drawings

[04P UMNL PIN HDR ASSY NATL LF](#)

English

CAD Files

[3D PDF](#)

English

Customer View Model

[ENG_CVM_350430-4_Y.2d_dxf.zip](#)

English

Customer View Model

[ENG_CVM_350430-4_Y.3d_igs.zip](#)

English

Customer View Model

[ENG_CVM_350430-4_Y.3d_stp.zip](#)

English

[3D PDF](#)



3D

Customer View Model

[ENG_CVM_CVM_350430-4_AE.2d_dxf.zip](#)

English

Customer View Model

[ENG_CVM_CVM_350430-4_AE.3d_igs.zip](#)

English

Customer View Model

[ENG_CVM_CVM_350430-4_AE.3d_stp.zip](#)

English

By downloading the CAD file I accept and agree to the [Terms and Conditions](#) of use.

Datasheets & Catalog Pages

[SOFT_SHELL_PIN_SOCKET_CONNECTORS_STANDARD_DENSITY](#)

English

Product Specifications

[Application Specification](#)

English

Agency Approvals

[UL](#)

English