

1-2178029-2 ✓ ACTIVE

RAST | RAST 5 IDC Connectors

TE Internal #: 1-2178029-2

Housing, Receptacle, Wire-to-Wire, 2 Position, 5 mm [.197 in]
Centerline, Crimp, 1 Row, Red, Mating Retention, Wire & Cable,
RAST 5 IDC Connectors

[View on TE.com >](#)



Connectors > PCB Connectors > Wire-to-Board Connectors > Wire-to-Board Connector Assemblies & Housings

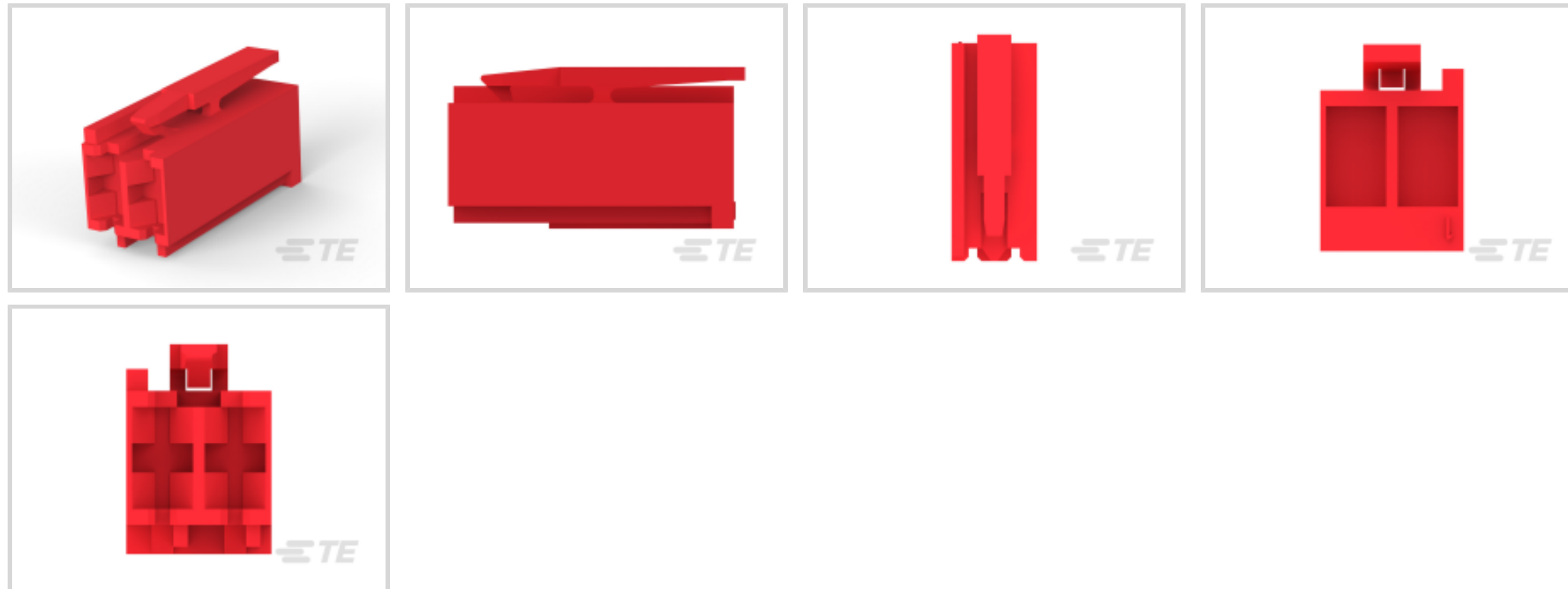

Connector Product Type: **Housing**

Connector & Housing Type: **Receptacle**

Connector System: **Wire-to-Wire**

Number of Positions: **2**

Centerline (Pitch): **5 mm [.197 in]**

Features

Product Type Features

Connector Product Type	Housing
Connector & Housing Type	Receptacle
Connector System	Wire-to-Wire
Sealable	No
Connector & Contact Terminates To	Wire & Cable

Configuration Features

Number of Positions	2
Number of Rows	1
Keying & Polarized Rib Location	1b,2b

Housing Features

Centerline (Pitch)	5 mm [.197 in]
Housing Material	PA 66

Termination Features

Termination Method to Wire & Cable	Crimp
------------------------------------	-------



Body Features

Primary Product Color	Red
-----------------------	-----

Mechanical Attachment

Mating Retention	With
Connector Mounting Type	Cable Mount (Free-Hanging)
Locking Latch Between Cavity Number	1&2
Mating Retention Type	Latch

Operation/Application

Circuit Application	Power & Signal
---------------------	----------------

Usage Conditions

Operating Temperature Range	-40 – 105 °C[-40 – 221 °F]
-----------------------------	----------------------------

Other

EU RoHS Compliance	Compliant
EU ELV Compliance	Compliant

Contact Features

Contact Type	Tab
--------------	-----

Dimensions

Connector Height	25.5 mm[1 in]
Connector Length	10 mm[.393 in]

Industry Standards

RAST Version	02-I
--------------	------

Packaging Features

Packaging Method	Package
Packaging Quantity	6000

Product Compliance

[For compliance documentation, visit the product page on TE.com>](#)

EU RoHS Directive 2011/65/EU	Compliant
EU ELV Directive 2000/53/EC	Compliant
China RoHS 2 Directive MIIT Order No 32, 2016	No Restricted Materials Above Threshold
EU REACH Regulation (EC) No. 1907/2006	



Current ECHA Candidate List: JUNE 2024

(241)

Candidate List Declared Against: JAN 2024

(240)

Does not contain REACH SVHC

Halogen Content

Not Low Halogen - contains Br or Cl > 900 ppm.

Solder Process Capability

Not reviewed for solder process capability

Product Compliance Disclaimer

This information is provided based on reasonable inquiry of our suppliers and represents our current actual knowledge based on the information they provided. This information is subject to change. The part numbers that TE has identified as EU RoHS compliant have a maximum concentration of 0.1% by weight in homogenous materials for lead, hexavalent chromium, mercury, PBB, PBDE, DBP, BBP, DEHP, DIBP, and 0.01% for cadmium, or qualify for an exemption to these limits as defined in the Annexes of Directive 2011/65/EU (RoHS2). Finished electrical and electronic equipment products will be CE marked as required by Directive 2011/65/EU. Components may not be CE marked. Additionally, the part numbers that TE has identified as EU ELV compliant have a maximum concentration of 0.1% by weight in homogenous materials for lead, hexavalent chromium, and mercury, and 0.01% for cadmium, or qualify for an exemption to these limits as defined in the Annexes of Directive 2000/53/EC (ELV). Regarding the REACH Regulation, the information TE provides on SVHC in articles for this part number is based on the latest European Chemicals Agency (ECHA) 'Guidance on requirements for substances in articles' posted at this URL: <https://echa.europa.eu/guidance-documents/guidance-on-reach>

Compatible Parts



TE Part # 6-1241961-2
STD TIM HOUSING MKII 2POS



TE Part # 4-1241965-2
STD TIMER HOUSING



TE Part # 6-1241983-2
STANDARD TIMER HOUSING MARK II



TE Part # 3-964951-2
STD TIMER GEH 2P



TE Part # 1955422-1
STD TIM MK2 GEH 2P



TE Part # 1987456-1
2 POS. RAST 5 HOUSING (SPECIAL



TE Part # 2-2178029-2
2P ST-TIMER HSG BLACK, V0



TE Part # 2-2178029-5
STD TIMER GEH 5P_V0



Also in the Series | **RAST 5 IDC Connectors**

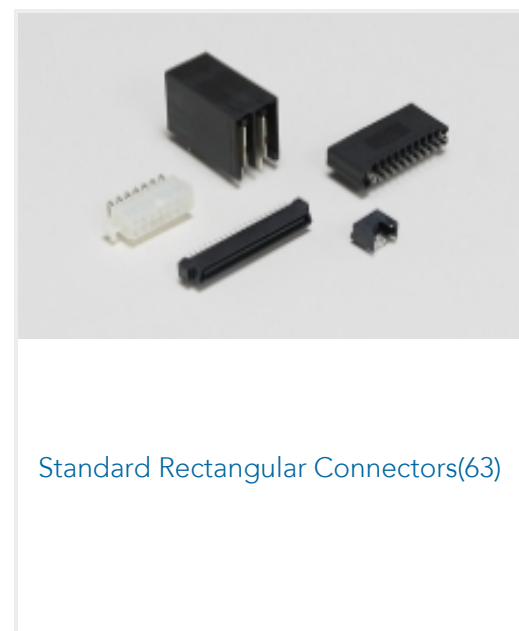
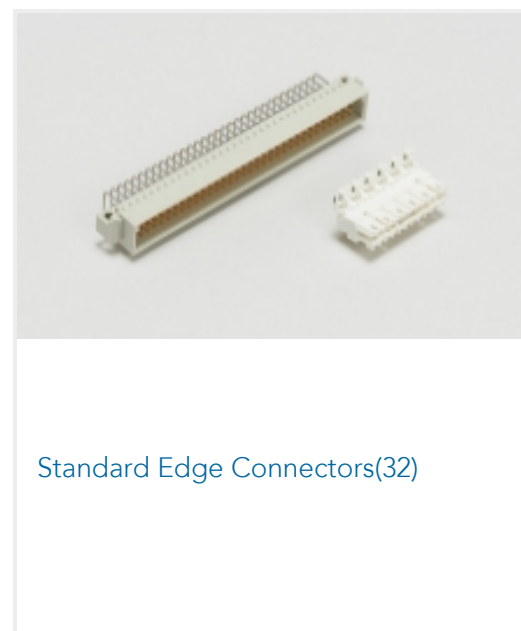
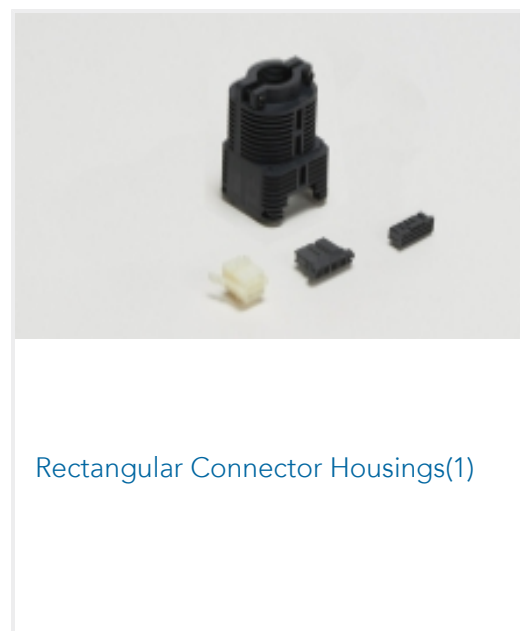
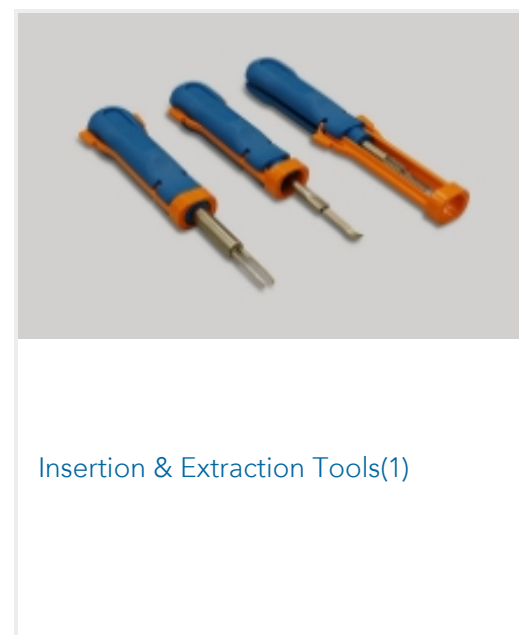
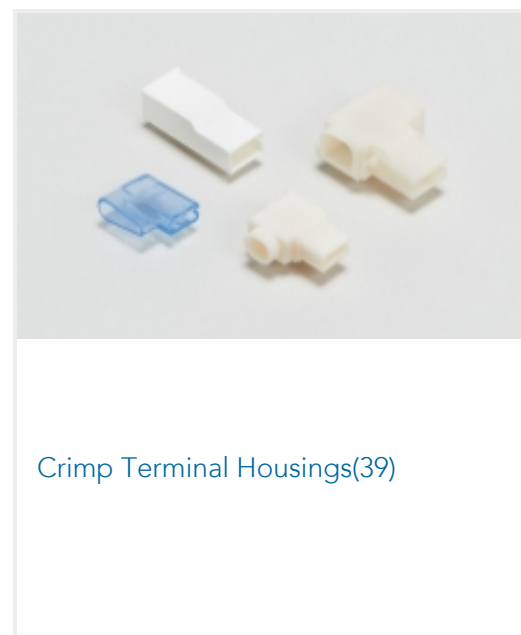
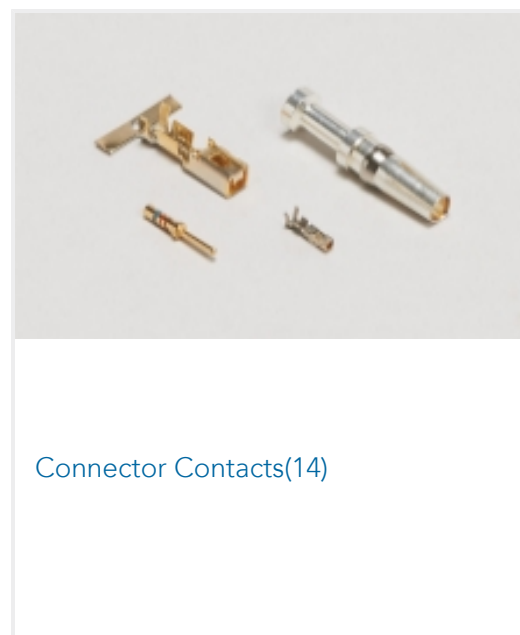
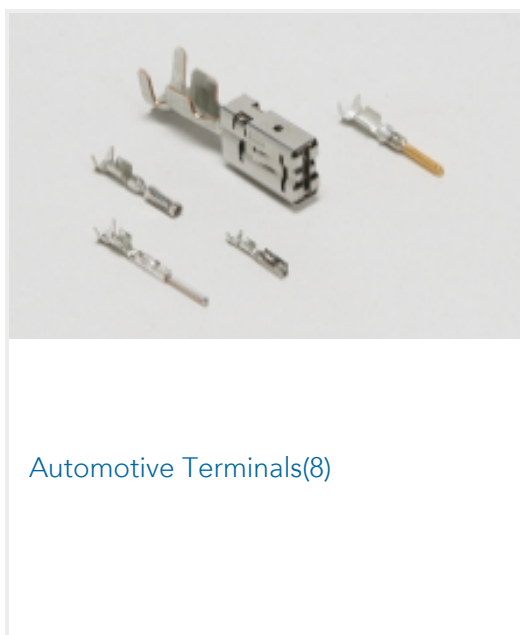

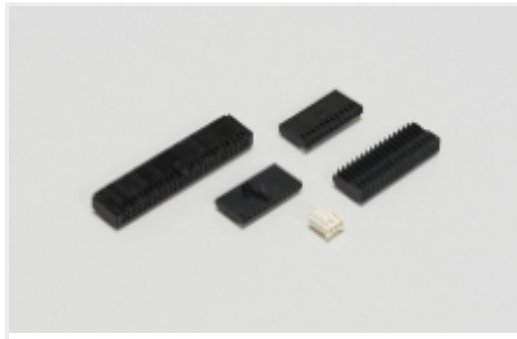

Wire-to-Board Connector Assemblies & Housings(203)

Customers Also Bought



TE Part #DT04-2P
REC, 2P, GRY, N



TE Part #W2S
Wedgelocks: DEUTSCH DT



TE Part #0460-202-16141
DEUTSCH Solid Contacts



TE Part #282104-1
AMP SUPERSEAL 1.5MM,
CONNECTOR HOUSING



TE Part #DT06-2S
PLG, 2P, GRY, N

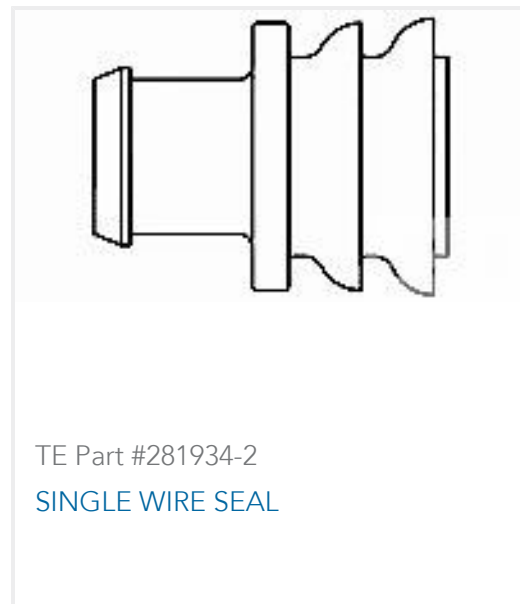

TE Part #281934-2
SINGLE WIRE SEAL



TE Part #114017-ZZ
SEALING PLUG, SIZE 12/16, WHT

Documents

Product Drawings

2P ST-TIMER RED, V0

English

CAD Files

3D PDF

3D

Customer View Model

[ENG_CVM_CVM_1-2178029-2_A_c-1-2178029-2-a.2d_dxf.zip](#)

English

Customer View Model

[ENG_CVM_CVM_1-2178029-2_A_c-1-2178029-2-a.3d_igs.zip](#)

English

Customer View Model

[ENG_CVM_CVM_1-2178029-2_A_c-1-2178029-2-a.3d_stp.zip](#)

English

By downloading the CAD file I accept and agree to the [Terms and Conditions](#) of use.



Datasheets & Catalog Pages

[RAST Connector System Catalog](#)

English

Product Specifications

[Product Specification](#)

German

Agency Approvals

[VDE Certificate](#)

English