

1744036-5 ✓ ACTIVE



Economy Power

TE Internal #: 1744036-5

Housing, Plug, Wire-to-Board, 5 Position, 5.08 mm [.2 in]
Centerline, Wire & Cable, UL 94V-0, Economy Power, Rectangular
Power Connectors

[View on TE.com >](#)

Connectors > Power Connectors > Rectangular Power > Rectangular Power Connectors



EU RoHS Compliance: **Compliant**

EU ELV Compliance: **Compliant**

Rectangular Power Connector Type: **Housing**

Connector & Housing Type: **Plug**

Connector System: **Wire-to-Board**

Features

Other

EU RoHS Compliance	Compliant
EU ELV Compliance	Compliant

Product Type Features

Rectangular Power Connector Type	Housing
Connector & Housing Type	Plug
Connector System	Wire-to-Board
Sealable	No
Connector & Contact Terminates To	Wire & Cable

Configuration Features

Number of Positions	5
Number of Rows	1

Electrical Characteristics

Operating Voltage	250 VDC
-------------------	---------



Contact Features

Contact Layout	Inline
Contact Current Rating (Max)	7.5 A
Contact Retention Within Housing	Without
Contact Type	Receptacle

Termination Features

Termination Method to Wire & Cable	Crimp
------------------------------------	-------

Mechanical Attachment

Strain Relief	Without
Panel Mount Feature	Without
Mating Retention Type	Locking Latch, Latch
PCB Mount Retention	Without
Mating Retention	With
Mating Alignment Type	Polarization
Mating Alignment	With
Connector Mounting Type	Cable Mount (Free-Hanging)

Housing Features

Centerline (Pitch)	5.08 mm [.2 in]
Housing Color	Natural
Housing Material	Nylon

Dimensions

Compatible Insulation Diameter Range	1.7 – 3 mm [.067 – .118 in]
Product Width	13.3 mm [.524 in]
Product Length	24.22 mm [.954 in]
Connector Height	10.5 mm [.413 in]

Usage Conditions

Operating Temperature Range	-25 – 105 °C [-13 – 221 °F]
-----------------------------	-----------------------------

Operation/Application

Circuit Application	Power & Signal
---------------------	----------------

Industry Standards

UL Flammability Rating	UL 94V-0
Glow Wire Rating	Standard Part - Not Glow Wire



Packaging Features

Packaging Quantity	1000
Packaging Method	Bag

Product Compliance

[For compliance documentation, visit the product page on TE.com>](#)

EU RoHS Directive 2011/65/EU	Compliant
EU ELV Directive 2000/53/EC	Compliant
China RoHS 2 Directive MIIT Order No 32, 2016	No Restricted Materials Above Threshold
EU REACH Regulation (EC) No. 1907/2006	Current ECHA Candidate List: JUNE 2024 (241) Candidate List Declared Against: JUNE 2024 (241) Does not contain REACH SVHC
Halogen Content	Low Halogen - Br, Cl, F, I < 900 ppm per homogenous material. Also BFR/CFR/PVC Free
Solder Process Capability	Not applicable for solder process capability

Product Compliance Disclaimer

This information is provided based on reasonable inquiry of our suppliers and represents our current actual knowledge based on the information they provided. This information is subject to change. The part numbers that TE has identified as EU RoHS compliant have a maximum concentration of 0.1% by weight in homogenous materials for lead, hexavalent chromium, mercury, PBB, PBDE, DBP, BBP, DEHP, DIBP, and 0.01% for cadmium, or qualify for an exemption to these limits as defined in the Annexes of Directive 2011/65/EU (RoHS2). Finished electrical and electronic equipment products will be CE marked as required by Directive 2011/65/EU. Components may not be CE marked. Additionally, the part numbers that TE has identified as EU ELV compliant have a maximum concentration of 0.1% by weight in homogenous materials for lead, hexavalent chromium, and mercury, and 0.01% for cadmium, or qualify for an exemption to these limits as defined in the Annexes of Directive 2000/53/EC (ELV). Regarding the REACH Regulation, the information TE provides on SVHC in articles for this part number is based on the latest European Chemicals Agency (ECHA) 'Guidance on requirements for substances in articles' posted at this URL: <https://echa.europa.eu/guidance-documents/guidance-on-reach>

Compatible Parts



TE Part # 2-1744036-6
06P ECONOMY POWER .200 CL HSG



TE Part # 2-1565036-1
EP CONN.HDR ASSY 4/5POS (NATURAL GWT)



TE Part # 1744037-5
05P EC PWR.200 CL HDR ASSY VRT



TE Part # 1744048-5
05P EC PWR.200 CL HDR ASSY RA



TE Part # 7-1123722-5
3.96 EP PLUG HSG 5P(NATURAL)



TE Part # 1744427-5
EP Header Assy, Shrouded, 5 Pos, GW



TE Part # 2-1717011-5
EP CONN.HDR ASSY 5/6POS-W/O NO.5



TE Part # 5-1717011-4
EP CONN.HDR ASSY 4/5POS-W/O NO.2



TE Part # 5-1717011-5
EP CONN.HDR ASSY 5/6POS-W/O NO.5



TE Part # 6-1717011-4
EP CONN.HDR ASSY 4/5POS-W/O NO.2

Also in the Series | Economy Power

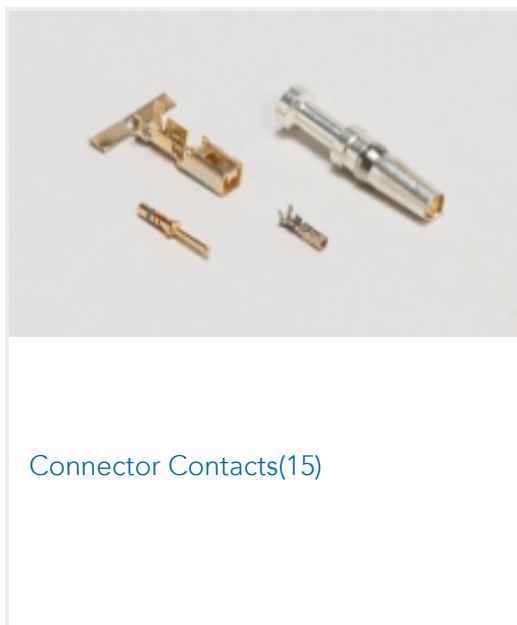

Connector Contacts(15)

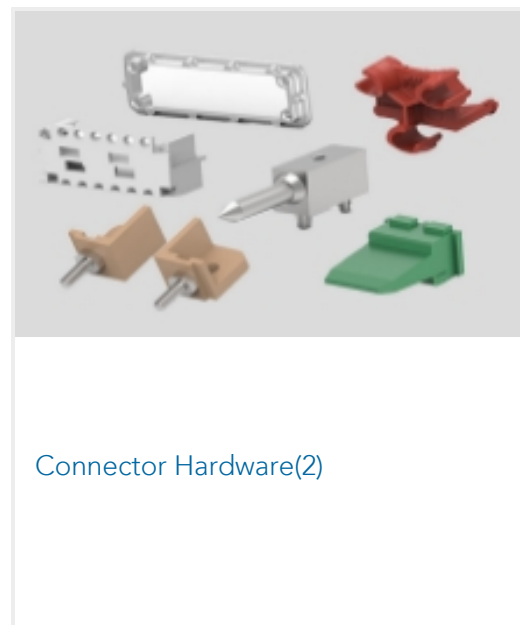

Connector Hardware(2)

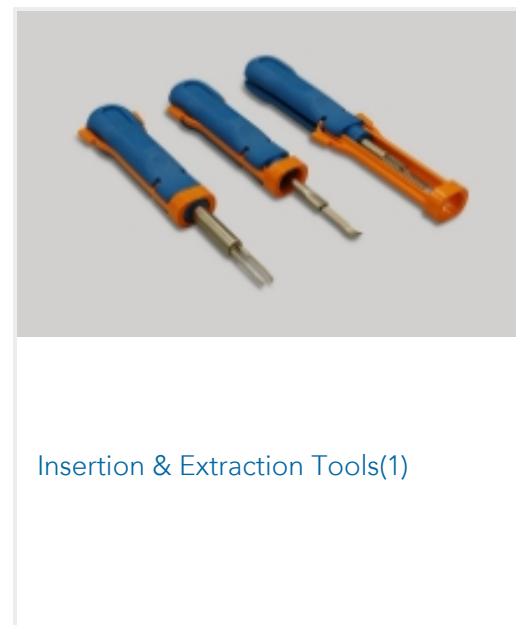

Insertion & Extraction Tools(1)



PCB Headers & Receptacles(402)

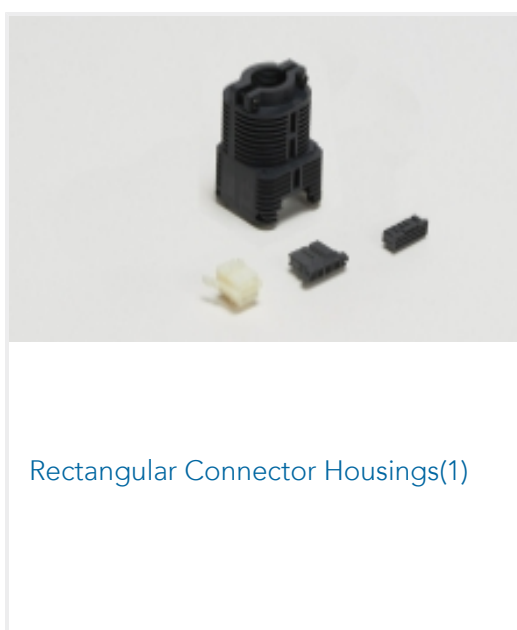

Rectangular Connector Housings(1)

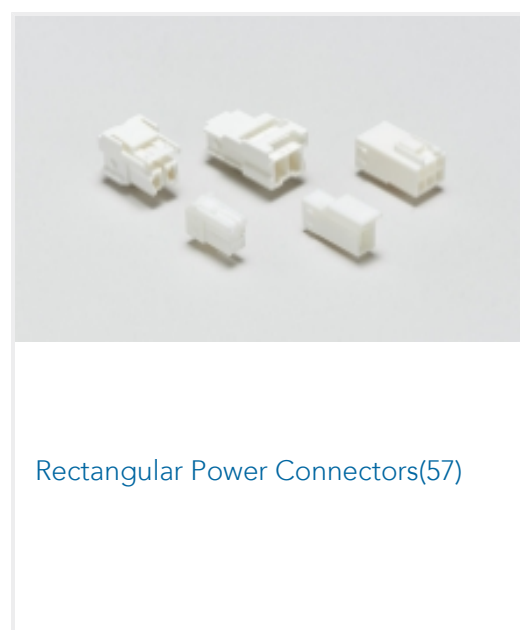

Rectangular Power Connectors(57)

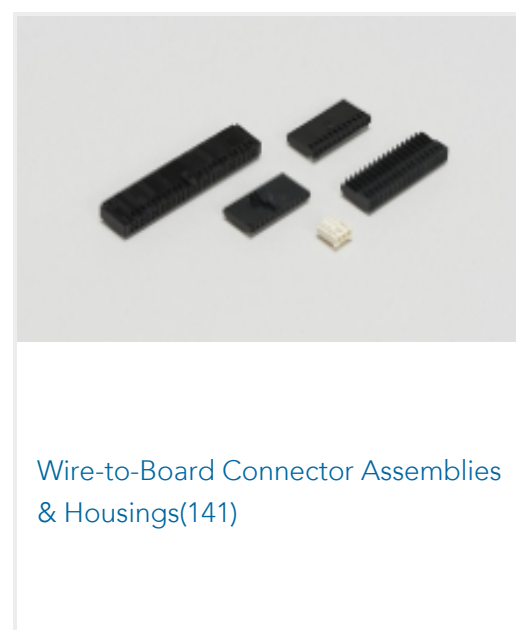

Wire-to-Board Connector Assemblies & Housings(141)

Customers Also Bought



TE Part #1-1744074-1
11P SL LID HSG W/O RAMP SPECIAL CL



TE Part #177911-1
POWER DBL LOCK CAP HSG P/M 9P



TE Part #1-794608-0
PIN CONT 20-24 TIN PLATE STRIP



TE Part #2-35771-1
TERMINAL, SOLIS R 12-10 10

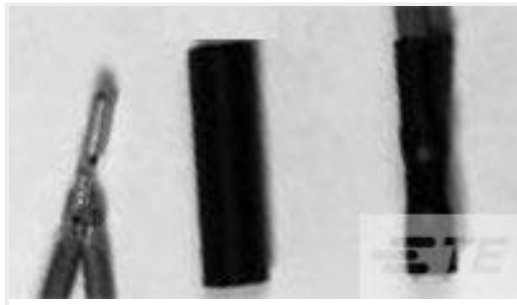

TE Part #520206P036
RT-3-NO.1-0-1IN



TE Part #1744036-3
03P ECONOMY POWER .200 CL HSG



TE Part #1744544-4
EP II TPA 04P, BLACK

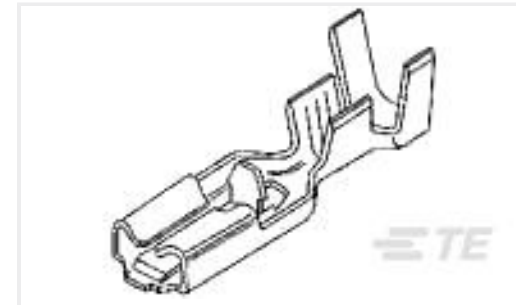

TE Part #1742354-1
PL 250 REC 16-18AWG PTBR



TE Part #1-1744036-0
10P ECONOMY POWER .200 CL HSG

Documents

Product Drawings

[05P ECONOMY POWER .200 CL HSG](#)

English

CAD Files

[3D PDF](#)

3D

Customer View Model

[ENG_CVM_CVM_1744036-5_B.2d_dxf.zip](#)

English

Customer View Model

[ENG_CVM_CVM_1744036-5_B.3d_igs.zip](#)

English

Customer View Model

[ENG_CVM_CVM_1744036-5_B.3d_stp.zip](#)

English

By downloading the CAD file I accept and agree to the [Terms and Conditions](#) of use.

Datasheets & Catalog Pages

[1-1773885-9 Economy Power Connectors](#)

English

Product Specifications

[Application Specification](#)

Japanese

[Application Specification](#)

English

1744036-5

Housing, Plug, Wire-to-Board, 5 Position, 5.08 mm [.2 in] Centerline, Wire & Cable, UL 94V-0, Economy Power, Rectangular Power Connectors



[Agency Approvals](#)

[VDE Certificate](#)

English