

REV.	ECR/ECN No.	DESCRIPTION	DRAWN/DATE	CHECKED/DATE	APPROVED/DATE
A	ECN2022132	正式版发行	Abner 2022-08-30	Staven 2022-08-30	Sam 2022-08-30
B	ECN2024100801	增加按压行程及按压寿命	zhangzhiwei 24-09-10	tiger.tao 24-09-10	Rain Han 24-09-10

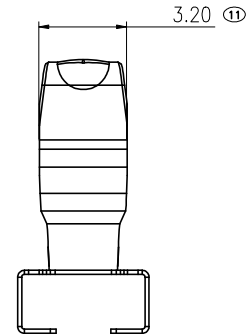

- NOTES:
- MATERIAL: SUS 304-H T=0.15mm;
 - BURR: 0.03mm MAX.
 - PLATING: 40u~120u NICKEL UNDER PLATED OVERALL, GOLD FLASH ON CONTACT AREA, WELDING FOG TIN PLATING 100 ~ 200u; 100~200u PURE MATTE TIN ON SOLDER TAILS.
 - ALL MATERIAL MUST BE COMPLY WITH RoHS;
 - CURRENT: 3A MAX.
 - COMPRESSION LIFE: 25CYCLES
 - RECOMMENDER WORKING HEIGHT=8.50mm MIN FORCE=1.5N MIN;
 - ENVIRONMENTAL: OPERATING TEMPERATURE: -40° C TO +105° C;

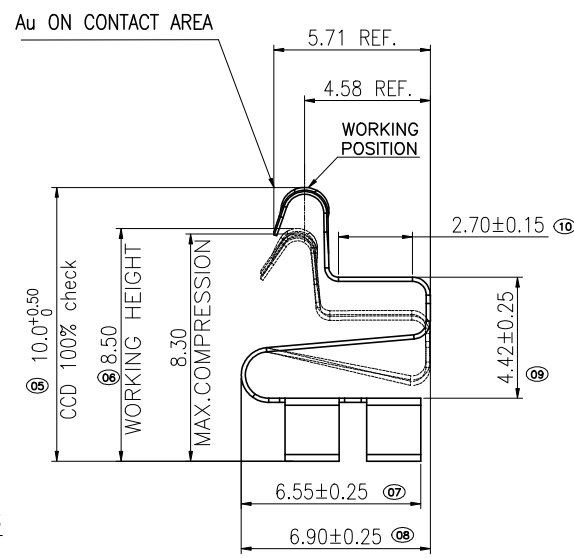
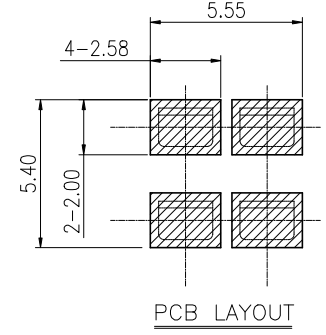
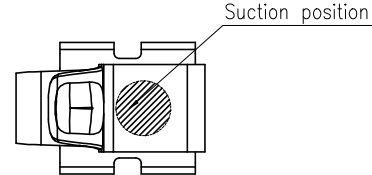
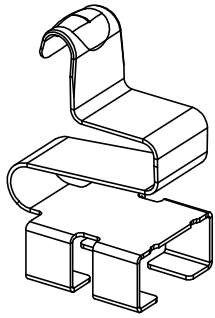
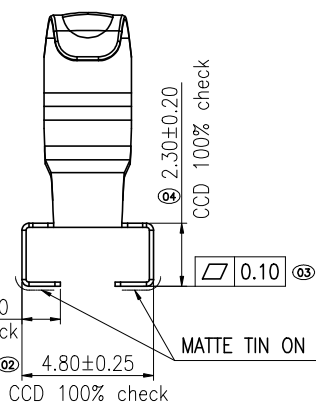

(1) 4-1.40±0.10
CCD 100% check

(2) 4.80±0.25
CCD 100% check

(3) 0.10

(4) 2.30±0.20
CCD 100% check

MATTE TIN ON SOLDER TAILS

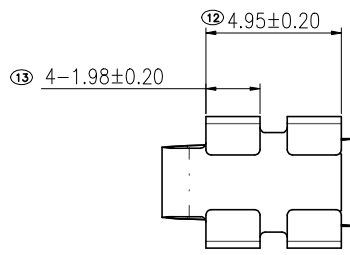
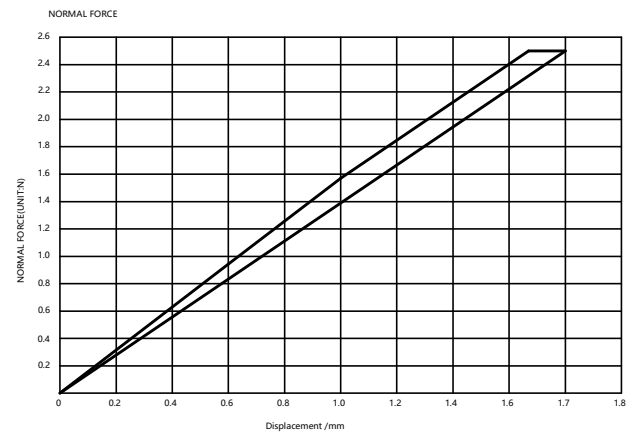

UNLESS OTHERWISE SPECIFIED TOLERANCES			ANGLE OF PROJECTION		Amphenol AORORA			
X.	±0.38	X. °	± 3'		Amphenol Aorora Technology (Huizhou) Co.,Ltd			
X.X	±0.30	X.X °	± 2'		TITLE: ESD CONATCT SPRING H=10mm			
X.XX	±0.25	X.XX °	± 1'	DOC TYP	Customer Drw		SIZE	
X.XXX	±0.15	X.XXX °	± 1'	DRAWN	Abner	2022-04-25		PART NUMBER: Z02L-4G7L1-11000-E000
LINEAR DIMS			ANGLES DIMS		DESIGN	Abner	2022-04-25	
DWG NO.: A-S0714					DATE	2022-04-25	SCALE	
MATERIAL	SEE NOTES				CHECKED	Staven		2022-04-25
FINISHED	SEE NOTES				APPROVED	Sam	2022-04-25	

This document is the property of and embodies CONFIDENTIAL and PROPRIETARY information of AAOR. No part of the information shown on this document may be used in any way or disclosed to others without the written consent of AAOR. © 2019 AAOR