

1326030-1 ✓ ACTIVE

1.5/2.8 Connector System

TE Internal #: 1326030-1

Receptacle, Mating Tab Width 2.8 mm [.11 in], Tab Thickness .8 mm [.031 in], 22 AWG Wire Size, 1.5/2.8 Connector System, Automotive Terminals

[View on TE.com >](#)



Terminals & Splices > Automotive Terminals > 1.5/2.8 CONNECTOR SYSTEM, RECPT AND TAB

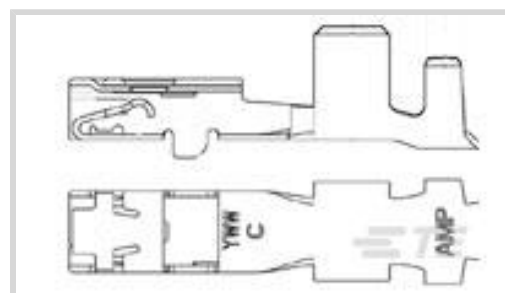

Terminal Type: **Receptacle**

Mating Tab Width: **2.8 mm [.11 in]**

Mating Tab Thickness: **.8 mm [.031 in]**

Terminal Transmits: **0 – 24 A (Low Power)**

Wire Size: **22 AWG**

[All 1.5/2.8 CONNECTOR SYSTEM, RECPT AND TAB \(37\)](#)

Features

Packaging Features

Packaging Method	Reel
Packaging Quantity	3000

Usage Conditions

Insulation Option	Uninsulated
Operating Temperature (Max)	80 °C, 125 °C, 105 °C, 90 °C, 100 °C, 85 °C, 110 °C, 120 °C[248 °F][221 °F][230 °F][176 °F][194 °F][185 °F][212 °F][257 °F]
Operating Temperature Range	-40 – 125 °C[-40 – 257 °F]

Termination Features

Termination Method to Wire & Cable	Crimp
Product Terminates To	Wire

Product Type Features

Receptacle Style	180°
Sealable	No

Dimensions

Compatible Insulation Diameter Range	1.2 – 4.04 mm[.047 – .161 in]
Wire Size	.35 mm ²



Wire Size Search	.35 mm ²
------------------	---------------------

Contact Features

Typical Current Rating	8.3 A
Crimp Type	F-Crimp
Contact Size	2.8mm
Contact Fabrication	Stamped & Formed
Wire Contact Termination Area Plating Material	Tin
Terminal Type	Receptacle
Mating Tab Width	2.8 mm[.11 in]
Mating Tab Thickness	.8 mm[.031 in]
Interface Plating	Tin (Sn)

Other

Terminal Transmits	0 – 24 A (Low Power)
EU RoHS Compliance	Compliant
EU ELV Compliance	Compliant

Product Compliance

[For compliance documentation, visit the product page on TE.com>](#)

EU RoHS Directive 2011/65/EU	Compliant
EU ELV Directive 2000/53/EC	Compliant
China RoHS 2 Directive MIIT Order No 32, 2016	No Restricted Materials Above Threshold
EU REACH Regulation (EC) No. 1907/2006	Current ECHA Candidate List: JUNE 2024 (241) Candidate List Declared Against: JUNE 2024 (241) Does not contain REACH SVHC
Halogen Content	Low Halogen - Br, Cl, F, I < 900 ppm per homogenous material. Also BFR/CFR/PVC Free
Solder Process Capability	Not applicable for solder process capability

Product Compliance Disclaimer

This information is provided based on reasonable inquiry of our suppliers and represents our current actual knowledge based on the information they provided. This information is subject to change. The part numbers that TE has identified as EU RoHS compliant have a maximum concentration of 0.1% by weight in homogenous materials for lead, hexavalent chromium, mercury, PBB, PBDE, DBP, BBP, DEHP, DIBP, and 0.01% for cadmium, or qualify for an exemption to these limits as defined in the Annexes of Directive 2011/65/EU (RoHS2). Finished electrical and electronic equipment products will be CE marked as required by Directive 2011/65/EU. Components may not be CE marked. Additionally, the part numbers that TE has identified as EU ELV compliant have a maximum concentration of 0.1% by weight in homogenous



materials for lead, hexavalent chromium, and mercury, and 0.01% for cadmium, or qualify for an exemption to these limits as defined in the Annexes of Directive 2000/53/EC (ELV). Regarding the REACH Regulation, the information TE provides on SVHC in articles for this part number is based on the latest European Chemicals Agency (ECHA) 'Guidance on requirements for substances in articles' posted at this URL: <https://echa.europa.eu/guidance-documents/guidance-on-reach>

Compatible Parts

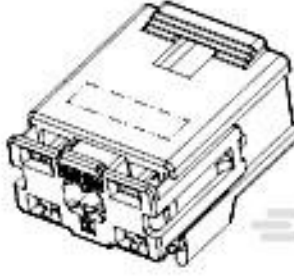

TE Part # 1456471-1
8p Hybrid 0.64/2.8 Unsealed Pl



TE Part # 1924126-1
21p Hybrid - 1pc Unsealed Plug, Key A



TE Part # 1924667-1
13p Hybrid - 1pc Unsealed Plug, Key A



TE Part # 1456471-2
8p Hybrid 0.64/2.8 Unsealed Plug Assy



TE Part # 1438759-1
22WAY HYBRID .040/2.8 PLUG ASSY KEY 'B'



TE Part # CAT-G3353-CH8172
GET .64 CONNECTOR SYSTEM, CONNECTOR HSG



TE Part # 776932-1
52 pos plug assy, 0.64 and 2.8



TE Part # 1452842-3
22 POS FEMALE HSG ASSY



TE Part # 1326359-1
11P 2.8MM LVG-HNG PLUG - KEY A



TE Part # 1438759-2
22Way Hybrid 040/2.8 Plug Assy Key "C"



TE Part # 2203937-1
52 pos plug assy, 0.64 and 2.8



TE Part # 2295163-1
22POS,MIXED,REC HSG,ASSY



TE Part # 2295163-2
22POS,MIXED,REC HSG,ASSY



TE Part # 2295163-3
22POS,MIXED,REC HSG,ASSY



TE Part # 2295163-4
22POS,MIXED,REC HSG,ASSY



TE Part # 776932-3
52 pos plug, 0.64 and 2.80mm



Also in the Series | 1.5/2.8 Connector System

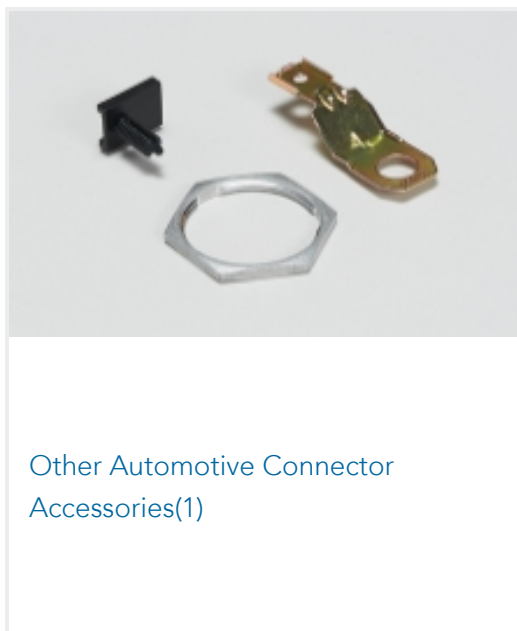
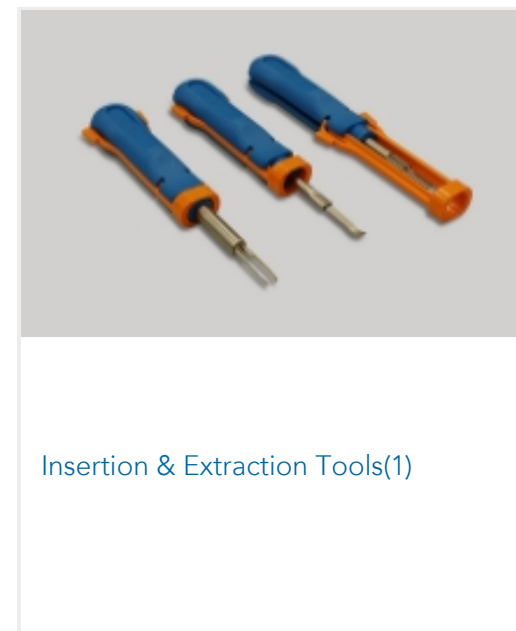
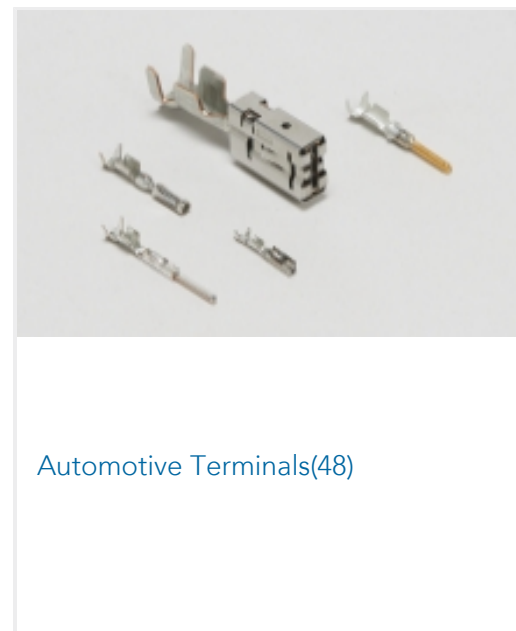
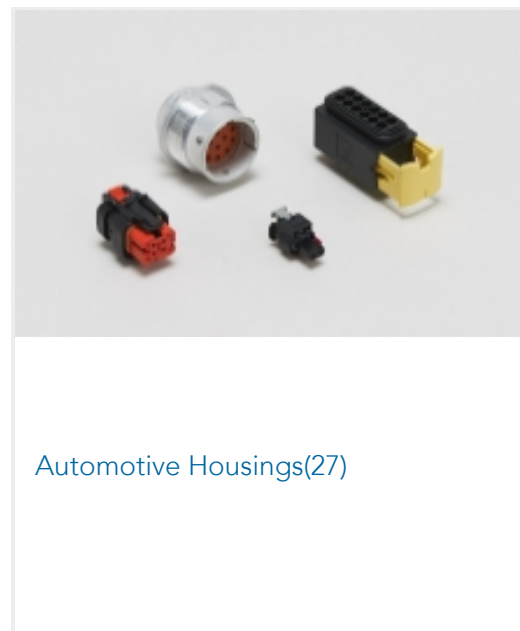
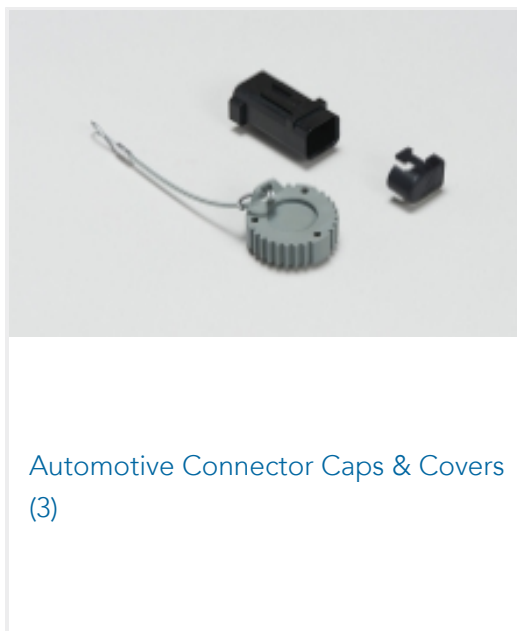

Customers Also Bought

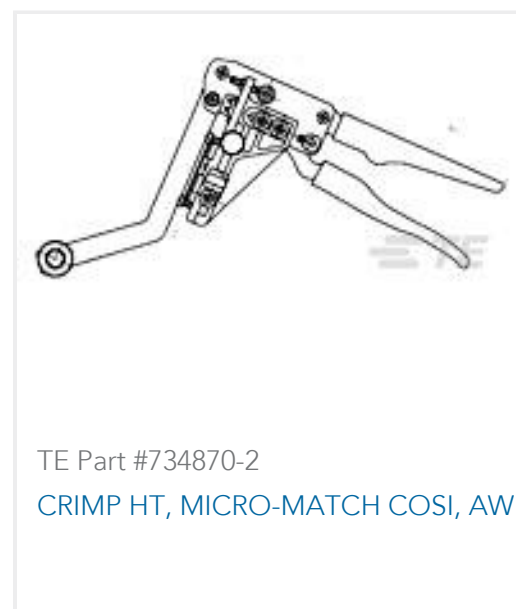



Documents

Product Drawings

[2.8MM RECP,UNSEAL,22AWG](#)

English

CAD Files

[3D PDF](#)

3D

Customer View Model

[ENG_CVM_CVM_1326030-1_L.2d_dxf.zip](#)

English

Customer View Model

[ENG_CVM_CVM_1326030-1_L.3d_igs.zip](#)

English

Customer View Model

[ENG_CVM_CVM_1326030-1_L.3d_stp.zip](#)

English

Customer View Model

[ENG_CVM_1326030-1_H1.3d_igs.zip](#)

English

Customer View Model

[ENG_CVM_1326030-1_H1.3d_stp.zip](#)

English

Customer View Model

[ENG_CVM_1326030-1_H1.2d_dxf.zip](#)

English

[3D PDF](#)

English

By downloading the CAD file I accept and agree to the [Terms and Conditions](#) of use.

Product Specifications

[Application Specification](#)

English