

32883 ✓ ACTIVE



PIDG

TE Internal #: 32883

Closed Ring Tongue Terminal, 12 – 10 AWG, #10 Stud Size, 5 mm [.197 in] Stud Diameter, Closed Barrel, Straight, Tin, Partially Insulated, PIDG

[View on TE.com >](#)

Terminals & Splices > Ring Terminals > PIDG Ring Tongue Terminals

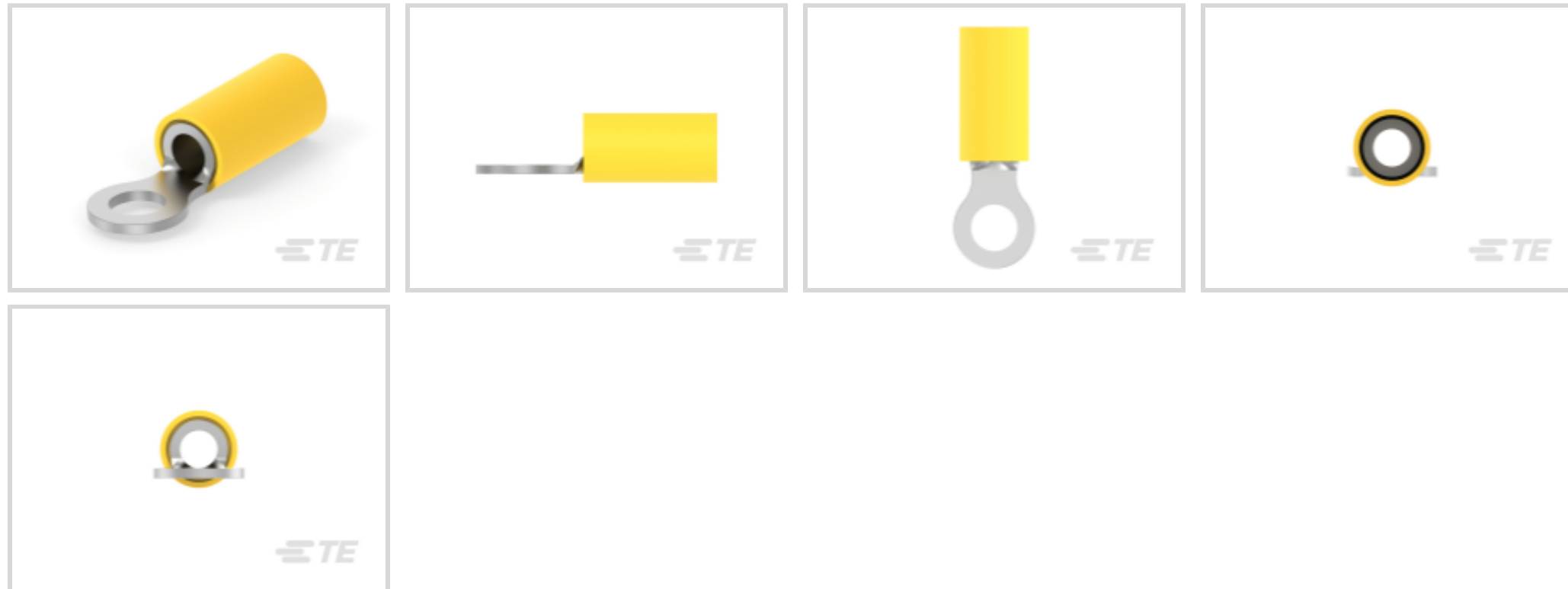

Ring Terminal Product Type: Closed Ring Tongue Terminal

Wire Size: 5180 – 13100 CMA

Stud Size: #10

[All PIDG Ring Tongue Terminals \(410\)](#)

Features

Product Type Features

Ring Terminal Product Type	Closed Ring Tongue Terminal
Stud Size	#10
Sealable	No
Wire Insulation Support Retention Type	Insulation Support

Dimensions

Wire Size	5180 – 13100 CMA
Stud Diameter	5 mm [.197 in]
Tongue Thickness	1.02 mm [.04 in]
Product Length	26.54 mm [1.045 in]
Compatible Insulation Diameter (Max)	5.84 mm [.23 in]
Compatible Insulation Diameter Range	3.81 – 5.84 mm [.15 – .23 in]

Contact Features

Barrel Type	Closed
Terminal Orientation	Straight

Terminal Plating Material	Tin
---------------------------	-----

Usage Conditions

Insulation Option	Partially Insulated
Operating Temperature Range	105 °C[221 °F]

Operation/Application

Compatible With Wire Base Material	Copper
Compatible With Wire Plating Material	Tin

Packaging Features

Packaging Method	Loose Piece
Packaging Quantity	500

Other

EU RoHS Compliance	Compliant
EU ELV Compliance	Compliant

Configuration Features

Number of Holes	1
-----------------	---

Electrical Characteristics

Voltage Rating	300 V
----------------	-------

Body Features

Insulation Sleeve Color	Yellow
Stripe Color	Yellow

Mechanical Attachment

Wire Insulation Support	With
-------------------------	------

Industry Standards

Government Qualified Terminal	No
-------------------------------	----

Product Compliance

[For compliance documentation, visit the product page on TE.com>](#)

EU RoHS Directive 2011/65/EU	Compliant
EU ELV Directive 2000/53/EC	Compliant
China RoHS 2 Directive MIIT Order No 32, 2016	No Restricted Materials Above Threshold
EU REACH Regulation (EC) No. 1907/2006	Current ECHA Candidate List: JUNE 2024 (241)

Candidate List Declared Against: JUNE 2024 (241)

Does not contain REACH SVHC

Halogen Content

Low Halogen - Br, Cl, F, I < 900 ppm per homogenous material. Also BFR/CFR/PVC Free

Solder Process Capability

Not applicable for solder process capability

Product Compliance Disclaimer

This information is provided based on reasonable inquiry of our suppliers and represents our current actual knowledge based on the information they provided. This information is subject to change. The part numbers that TE has identified as EU RoHS compliant have a maximum concentration of 0.1% by weight in homogenous materials for lead, hexavalent chromium, mercury, PBB, PBDE, DBP, BBP, DEHP, DIBP, and 0.01% for cadmium, or qualify for an exemption to these limits as defined in the Annexes of Directive 2011/65/EU (RoHS2). Finished electrical and electronic equipment products will be CE marked as required by Directive 2011/65/EU. Components may not be CE marked. Additionally, the part numbers that TE has identified as EU ELV compliant have a maximum concentration of 0.1% by weight in homogenous materials for lead, hexavalent chromium, and mercury, and 0.01% for cadmium, or qualify for an exemption to these limits as defined in the Annexes of Directive 2000/53/EC (ELV). Regarding the REACH Regulation, the information TE provides on SVHC in articles for this part number is based on the latest European Chemicals Agency (ECHA) 'Guidance on requirements for substances in articles' posted at this URL: <https://echa.europa.eu/guidance-documents/guidance-on-reach>

Compatible Parts

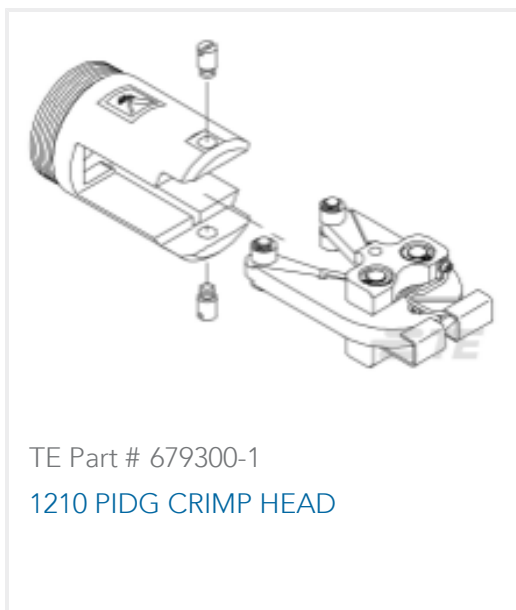

TE Part # 679300-1
1210 PIDG CRIMP HEAD



TE Part # 59824-1
TETRA-CRIMP PIDG PG FASTON 22-10 ASSY



TE Part # 58433-3
PRO CR ASSY, RBY IS9252



TE Part # 59239-4
HHHT PIDG PG 12-10 ASSY



TE Part # 539691-2
ERGO DIE R.B.Y



TE Part # 58423-1
DIE, RBY IS9252



TE Part # 525692
HHHT PIDG PG 12-10 ASSY



TE Part # 2063030-1
SDE DIESET, RBY, UL



Also in the Series | PIDG

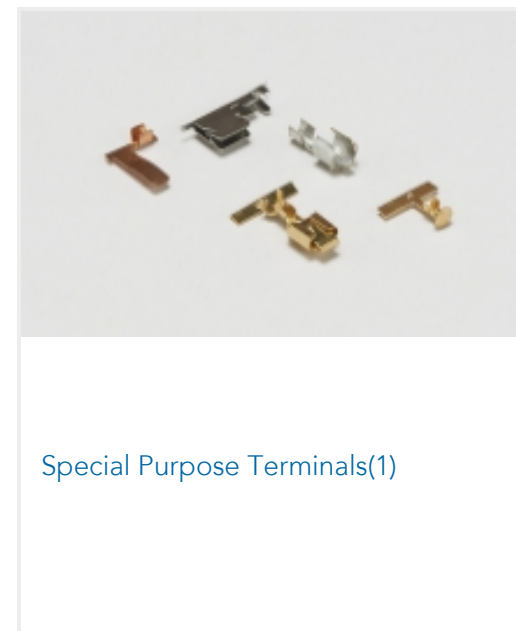
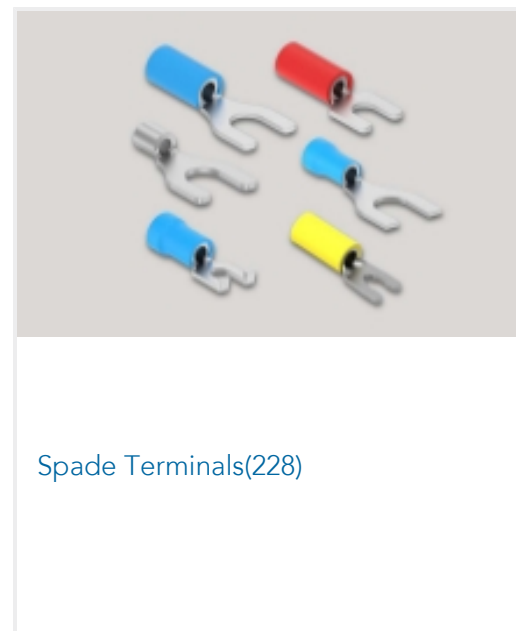
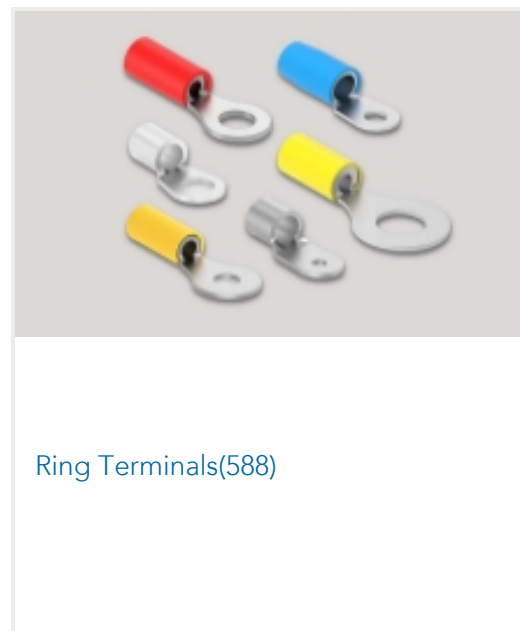
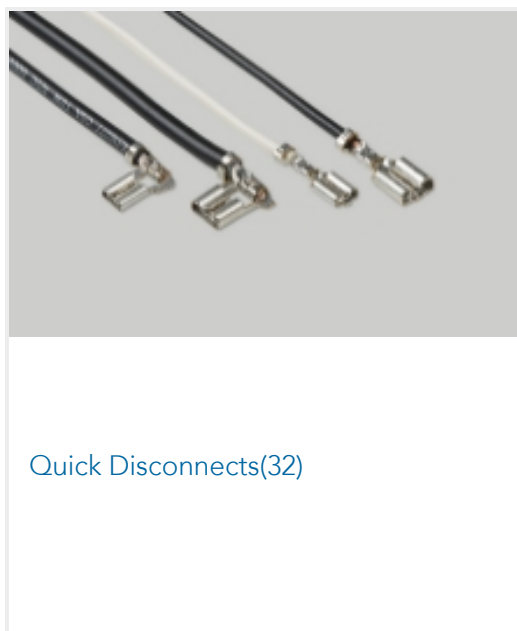
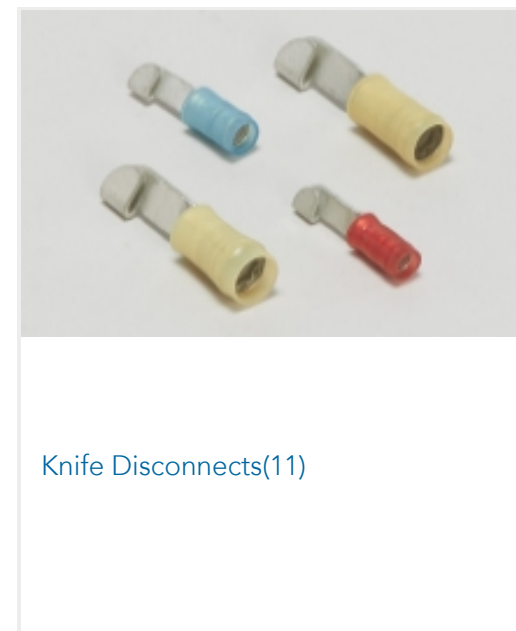
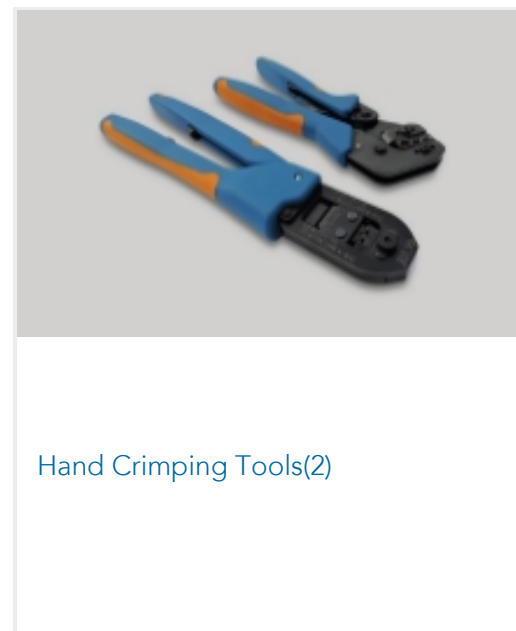
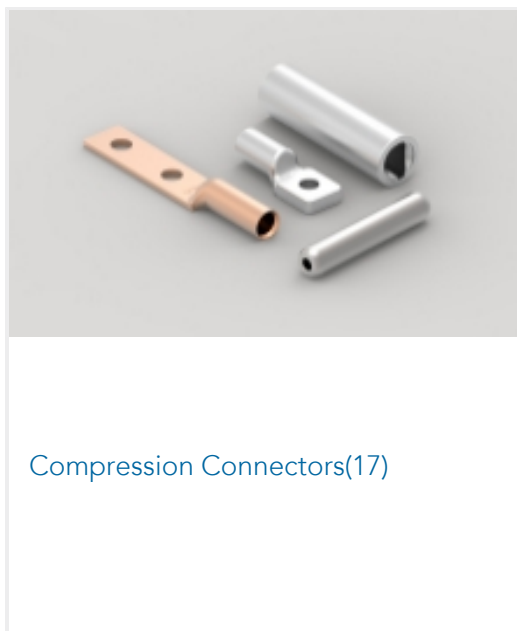

Customers Also Bought



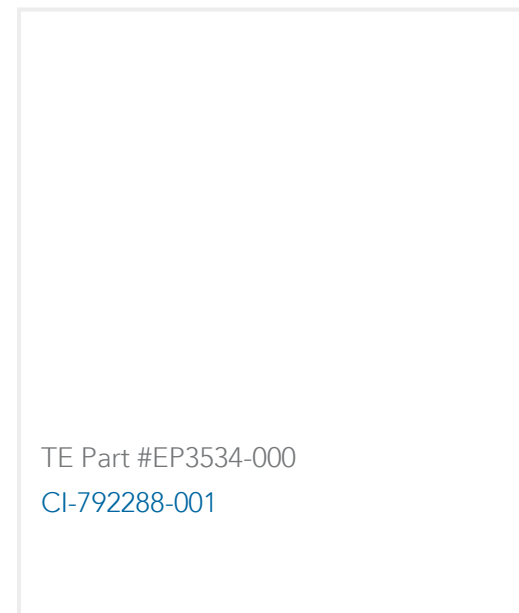
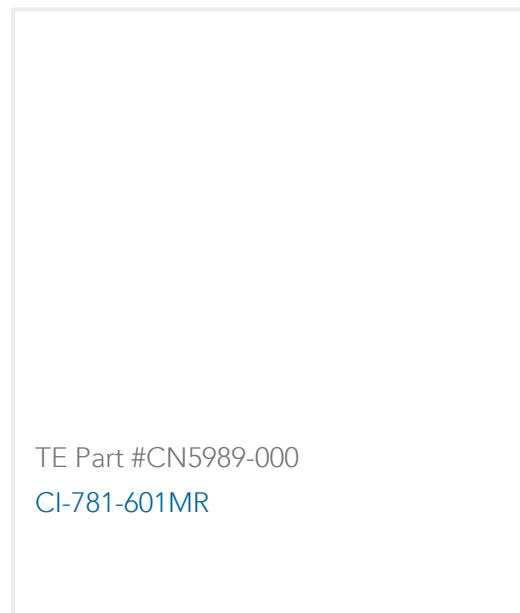

Documents

Product Drawings

[TERMINAL,PIDG R 12-10 10](#)

English

CAD Files

[3D PDF](#)

3D

Customer View Model

[ENG_CVM_CVM_32883_F.2d_dxf.zip](#)

English

Customer View Model

[ENG_CVM_CVM_32883_F.3d_igs.zip](#)

English

Customer View Model

[ENG_CVM_CVM_32883_F.3d_stp.zip](#)

English

Customer View Model

[ENG_CVM_32883_D1.3d_igs.zip](#)

English

Customer View Model

[ENG_CVM_32883_D1.3d_stp.zip](#)

English

Customer View Model

[ENG_CVM_32883_D1.2d_dxf.zip](#)

English

[3D PDF](#)

3D



By downloading the CAD file I accept and agree to the [Terms and Conditions](#) of use.

Datasheets & Catalog Pages

[PIDG TERMINALS & SPLICES Quick Reference Guide](#)

English

Instruction Sheets

[Instruction Sheet \(U.S.\)](#)

English

Agency Approvals

[UL Report](#)

English