

6-160526-2 ✓ ACTIVE

FASTIN-FASTON | FASTIN-FASTON 250

TE Internal #: 6-160526-2

Receptacle, 20 – 15 AWG Wire Size, .51 – 1.65 mm<sup>2</sup> Wire Size,  
Mating Tab Width 6.35 mm [.25 in], Straight, FASTIN-FASTON 250,  
Quick Disconnects

[View on TE.com >](#)



Terminals & Splices > Quick Disconnects

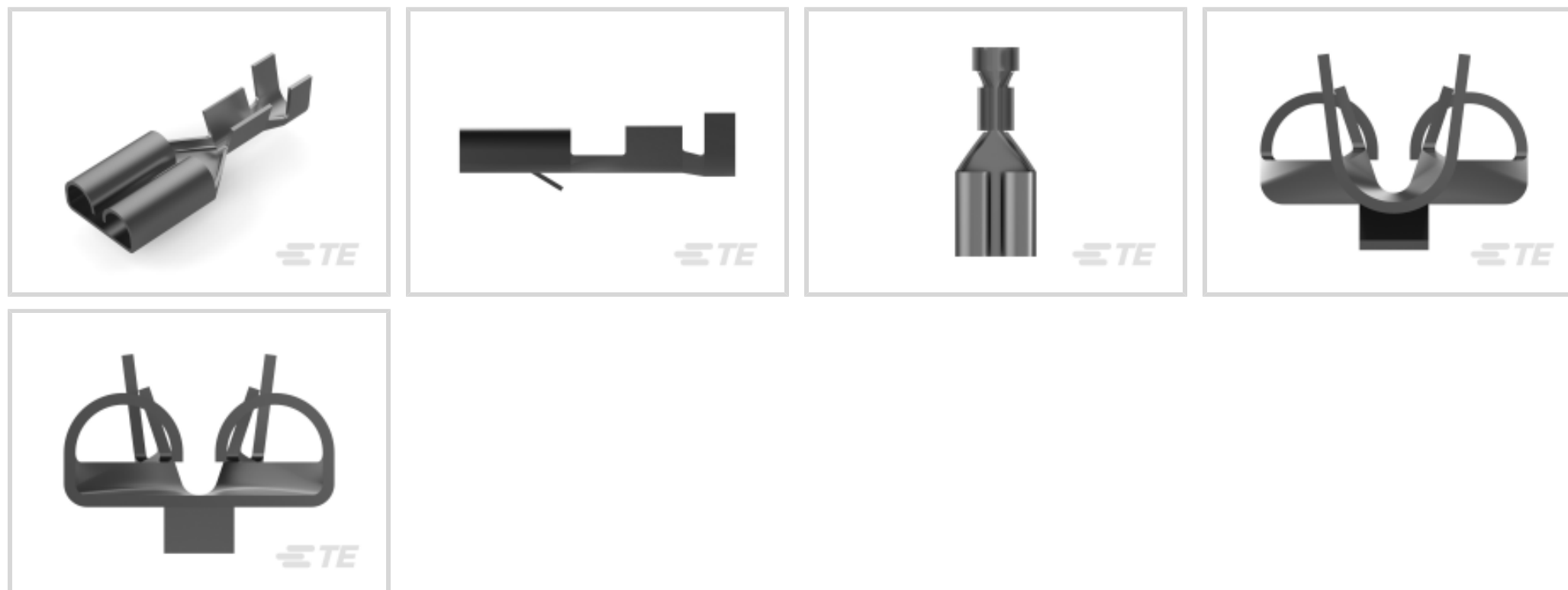

Quick Disconnect Terminal Type: **Receptacle**

Wire Size: .51 – 1.65 mm<sup>2</sup>

Mating Tab Width: 6.35 mm [.25 in]

Mating Tab Thickness: .81 mm [.032 in]

## Features

### Contact Features

Quick Disconnect Terminal Type	Receptacle
Mating Tab Width	6.35 mm [.25 in]
Mating Tab Thickness	.81 mm [.032 in]
Terminal Orientation	Straight
Contact Base Material	Phosphor Bronze
Terminal Plating Material	Tin
Crimp Type	F-Crimp
Barrel Type	Open

### Dimensions

Wire Size	.51 – 1.65 mm <sup>2</sup>
Product Length	19.2 mm [.755 in]
Compatible Insulation Diameter Range	2.31 – 3.3 mm [.091 – .13 in]
Terminal Material Thickness	.33 mm [.013 in]

### Packaging Features

Packaging Method	Strip/Reel
------------------	------------



Packaging Quantity	5000
--------------------	------

### Product Type Features

Insertion Force	Normal
-----------------	--------

### Usage Conditions

Insulation Option	Uninsulated
-------------------	-------------

Operating Temperature Range	-40 – 110 °C[-40 – 230 °F]
-----------------------------	----------------------------

### Other

EU RoHS Compliance	Compliant
--------------------	-----------

EU ELV Compliance	Compliant
-------------------	-----------

### Configuration Features

Compatible With Wire & Cable Type	Discrete Wire
-----------------------------------	---------------

Connection Capacity	Single
---------------------	--------

### Termination Features

Product Terminates To	Wire & Cable
-----------------------	--------------

### Mechanical Attachment

Locking Lance Height	.32 mm
----------------------	--------

Wire Insulation Support	With
-------------------------	------

Mating Retention Type	Locking Lance
-----------------------	---------------

### Product Compliance

[For compliance documentation, visit the product page on TE.com>](#)

EU RoHS Directive 2011/65/EU	Compliant
------------------------------	-----------

EU ELV Directive 2000/53/EC	Compliant
-----------------------------	-----------

China RoHS 2 Directive MIIT Order No 32, 2016	No Restricted Materials Above Threshold
---	---

EU REACH Regulation (EC) No. 1907/2006	Current ECHA Candidate List: JUNE 2024 (241) Candidate List Declared Against: JUNE 2024 (241) Does not contain REACH SVHC
--	---

Halogen Content	Low Halogen - Br, Cl, F, I < 900 ppm per homogenous material. Also BFR/CFR/PVC Free
-----------------	---

Solder Process Capability	Not applicable for solder process capability
---------------------------	--

Product Compliance Disclaimer

This information is provided based on reasonable inquiry of our suppliers and represents our current actual knowledge based on the information they provided. This information is subject to change. The part numbers that TE has identified as EU RoHS compliant have a maximum concentration of 0.1% by weight in homogenous materials for lead, hexavalent chromium, mercury, PBB, PBDE, DBP, BBP, DEHP, DIBP, and 0.01% for cadmium, or qualify for an exemption to these limits as defined in the Annexes of Directive 2011/65/EU (RoHS2). Finished electrical and electronic equipment products will be CE marked as required by Directive 2011/65/EU. Components may not be CE marked. Additionally, the part numbers that TE has identified as EU ELV compliant have a maximum concentration of 0.1% by weight in homogenous materials for lead, hexavalent chromium, and mercury, and 0.01% for cadmium, or qualify for an exemption to these limits as defined in the Annexes of Directive 2000/53/EC (ELV). Regarding the REACH Regulation, the information TE provides on SVHC in articles for this part number is based on the latest European Chemicals Agency (ECHA) 'Guidance on requirements for substances in articles' posted at this URL: <https://echa.europa.eu/guidance-documents/guidance-on-reach>

## Compatible Parts



## Also in the Series | FASTIN-FASTON 250

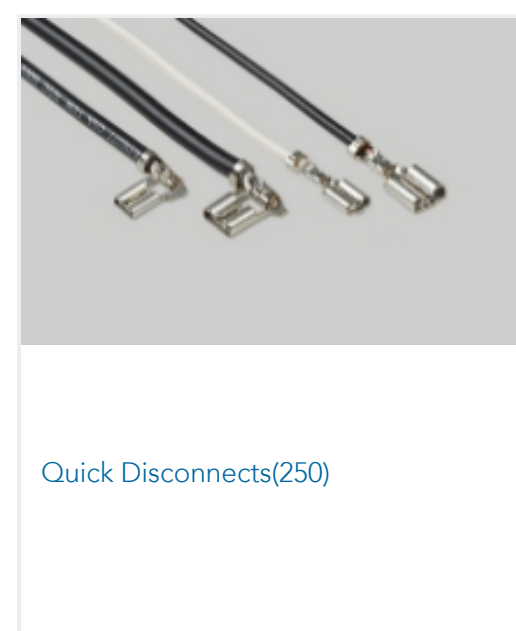
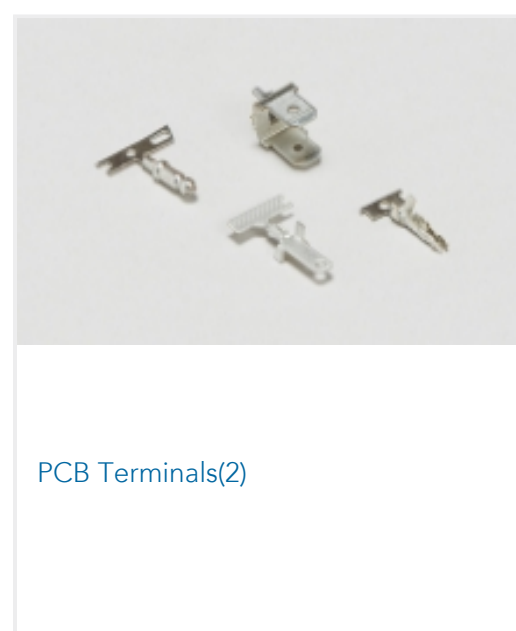
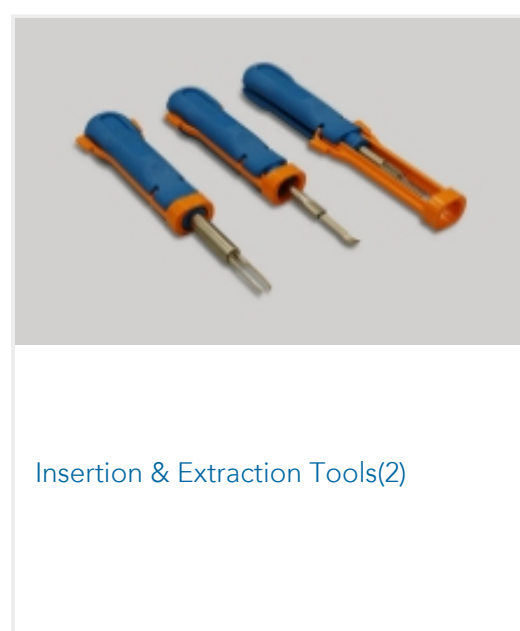
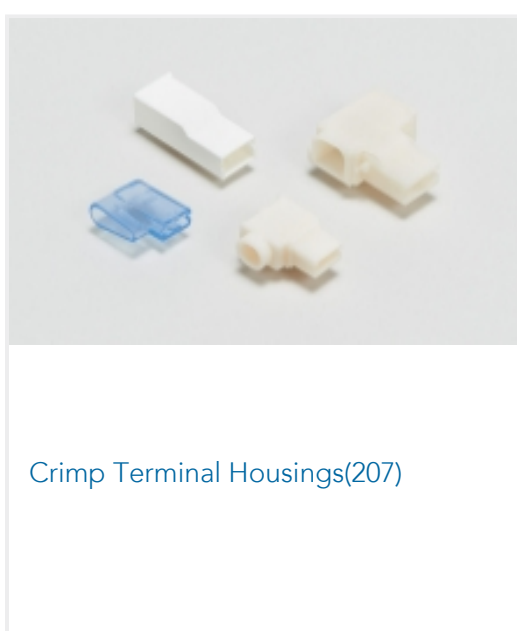

## Customers Also Bought

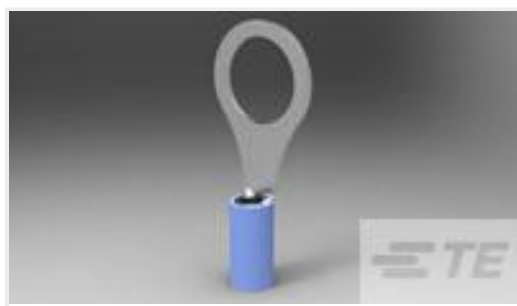

TE Part #328849  
TERMINAL,PIDG R 16-14 1/2



TE Part #151667-2  
FF 375 REC 4-6MM2 TPBR

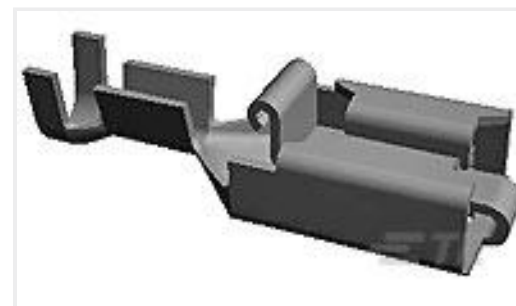

TE Part #154717-4  
PL 250 REC TERMINAL 13-11 AWG  
TPPB



TE Part #160864-2  
FF 110 REC TERMINAL 20-17 AWG  
PTPB



TE Part #6-160448-2  
FF 250 REC 1.0-2.5MM2 TPPB



TE Part #K1127687  
Battery Disconnect 35-511-260-S-A5-  
900



TE Part #K1002957  
Toggle Switch 08-4-1-25



TE Part #K1132117  
Relay 85-220-M-003



TE Part #CD35703001  
VG-95218-T020-G030

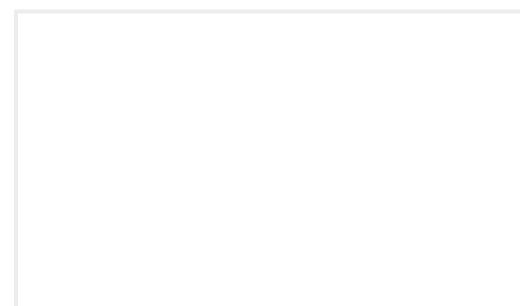

TE Part #890113-003  
S1048-TAPE-30M

## Documents

### Product Drawings

[FF 250 REC 0.5-1.5MM2 TPPB](#)

English

### CAD Files

[3D PDF](#)

3D

Customer View Model

[ENG\\_CVM\\_CVM\\_6-160526-2\\_AR.2d\\_dxf.zip](#)

English

Customer View Model

[ENG\\_CVM\\_CVM\\_6-160526-2\\_AR.3d\\_igs.zip](#)

English

Customer View Model

[ENG\\_CVM\\_CVM\\_6-160526-2\\_AR.3d\\_stp.zip](#)

English

By downloading the CAD file I accept and agree to the [Terms and Conditions](#) of use.

### Datasheets & Catalog Pages



## 1654742\_HOUSEHOLD\_APPLIANCES\_RAST5

English

---

### Product Specifications

**EB\*\*General Application Specification for Open Barrel Terminals**

English

### Application Specification

English