

179862-1 ✓ ACTIVE



Power Double Lock

TE Internal #: 179862-1

Housing, Plug, Wire-to-Board / Wire-to-Wire, 6 Position, 6.5 mm [.255 in] Centerline, Wire & Cable, Power Double Lock, Rectangular Power Connectors

[View on TE.com >](#)

Connectors > Power Connectors > Rectangular Power > Rectangular Power Connectors > STD Temp Power Double Lock Plug

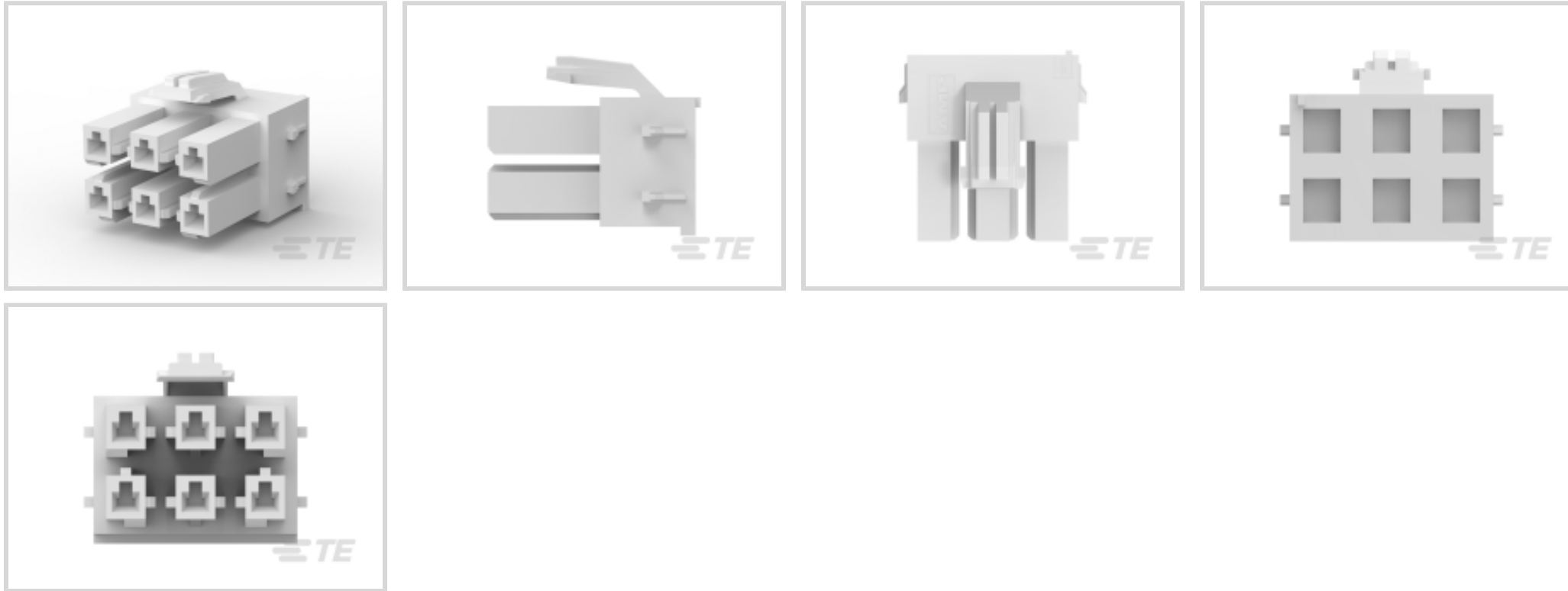

EU RoHS Compliance: **Compliant**

EU ELV Compliance: **Compliant**

Rectangular Power Connector Type: **Housing**

Connector & Housing Type: **Plug**

Connector System: **Wire-to-Board, Wire-to-Wire**

[All STD Temp Power Double Lock Plug \(66\)](#)

Features

Other

EU RoHS Compliance	Compliant
EU ELV Compliance	Compliant

Product Type Features

Compatible With Discrete Wire Type	Stranded
Rectangular Power Connector Type	Housing
Connector & Housing Type	Plug
Connector System	Wire-to-Board, Wire-to-Wire
Sealable	No
Connector & Contact Terminates To	Wire & Cable

Configuration Features

Number of Positions	6
Number of Rows	2



Electrical Characteristics

Operating Voltage	300 VAC
-------------------	---------

Contact Features

Contact Layout	Matrix
Contact Retention Within Housing	Without
Contact Type	Receptacle

Termination Features

Termination Method to Wire & Cable	Crimp
------------------------------------	-------

Mechanical Attachment

Connector Mounting Type	Cable Mount (Free-Hanging)
-------------------------	----------------------------

Housing Features

Centerline (Pitch)	6.5 mm [.255 in]
Housing Color	Natural
Housing Material	Nylon 6/6

Dimensions

Row-to-Row Spacing	6.5 mm [.256 in]
--------------------	------------------

Usage Conditions

Operating Temperature Range	-30 – 105 °C [-22 – 221 °F]
-----------------------------	-----------------------------

Operation/Application

Circuit Application	Power & Signal
---------------------	----------------

Industry Standards

Compatible With Agency/Standards Products	UL
Compatible With Approved Standards Products	UL 1977
UL Flammability Rating	UL 94V-0
Glow Wire Rating	Standard Part - Not Glow Wire

Packaging Features

Packaging Quantity	100
Packaging Method	Bag

Product Compliance

[For compliance documentation, visit the product page on TE.com>](#)



EU RoHS Directive 2011/65/EU	Compliant
EU ELV Directive 2000/53/EC	Compliant
China RoHS 2 Directive MIIT Order No 32, 2016	No Restricted Materials Above Threshold
EU REACH Regulation (EC) No. 1907/2006	Current ECHA Candidate List: JUNE 2024 (241) Candidate List Declared Against: JUNE 2024 (241) Does not contain REACH SVHC
Halogen Content	Low Halogen - Br, Cl, F, I < 900 ppm per homogenous material. Also BFR/CFR/PVC Free
Solder Process Capability	Not applicable for solder process capability

Product Compliance Disclaimer

This information is provided based on reasonable inquiry of our suppliers and represents our current actual knowledge based on the information they provided. This information is subject to change. The part numbers that TE has identified as EU RoHS compliant have a maximum concentration of 0.1% by weight in homogenous materials for lead, hexavalent chromium, mercury, PBB, PBDE, DBP, BBP, DEHP, DIBP, and 0.01% for cadmium, or qualify for an exemption to these limits as defined in the Annexes of Directive 2011/65/EU (RoHS2). Finished electrical and electronic equipment products will be CE marked as required by Directive 2011/65/EU. Components may not be CE marked. Additionally, the part numbers that TE has identified as EU ELV compliant have a maximum concentration of 0.1% by weight in homogenous materials for lead, hexavalent chromium, and mercury, and 0.01% for cadmium, or qualify for an exemption to these limits as defined in the Annexes of Directive 2000/53/EC (ELV). Regarding the REACH Regulation, the information TE provides on SVHC in articles for this part number is based on the latest European Chemicals Agency (ECHA) 'Guidance on requirements for substances in articles' posted at this URL: <https://echa.europa.eu/guidance-documents/guidance-on-reach>

Compatible Parts

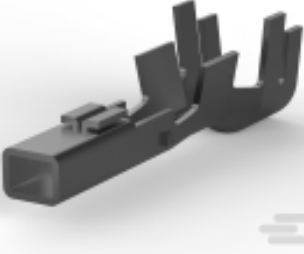
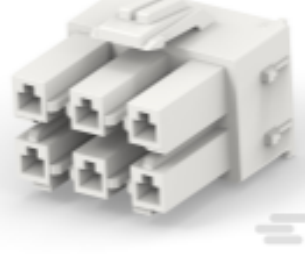
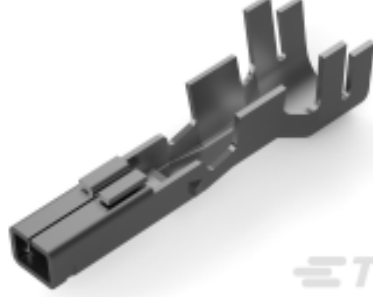
 <p>TE Part # CAT-P87024-R2435 Power Double Lock Receptacle</p>	 <p>TE Part # 2005252-1 PDL 6P PLUG 6.5 D/R(GWT) NAT</p>	 <p>TE Part # 179593-1 AMP POWER D/LOCK RECONT. L/P</p>	 <p>TE Part # 179849-1 AMP POWER D/LOCK T/HDR ASSY 6P</p>
 <p>TE Part # 179592-1 AMP POWER D/LOCK REC CONT. L/P</p>	 <p>TE Part # 179592-2 POWER D/LOCK REC CONT. H/P L/P</p>	 <p>TE Part # 179593-2 POWER D/LOCK REC CONT. H/P L/P</p>	 <p>TE Part # 1-179849-1 PDL 6P HDR 6.5 DR V/T ASSY NAT</p>

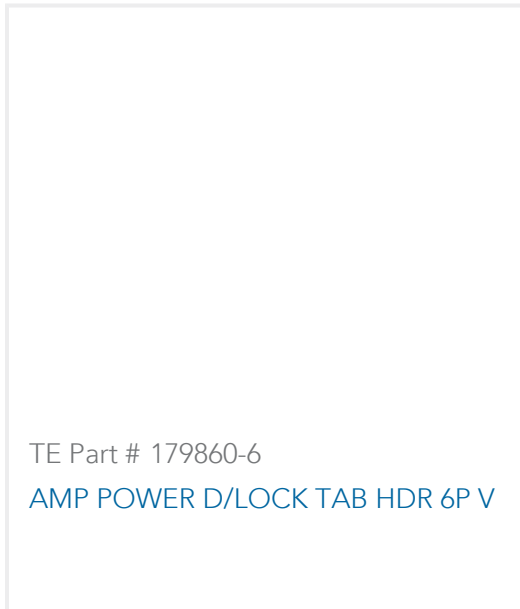
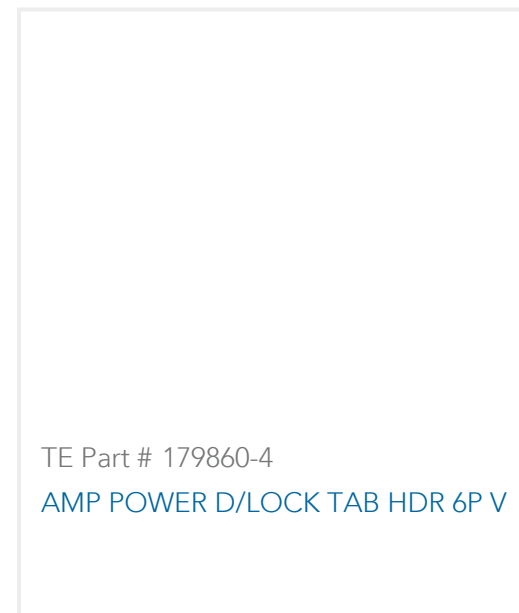
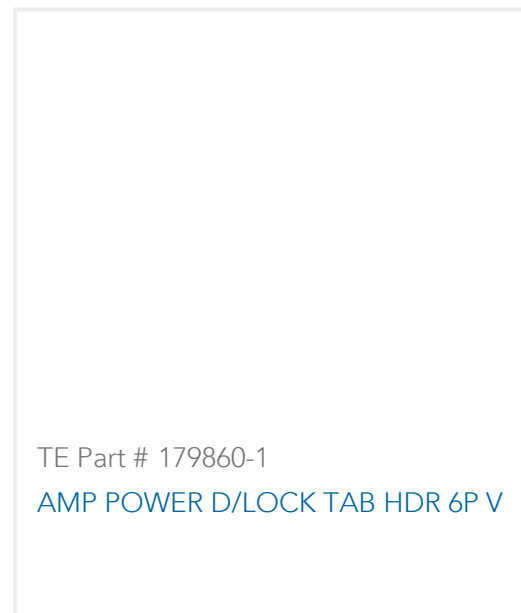

Also in the Series | Power Double Lock

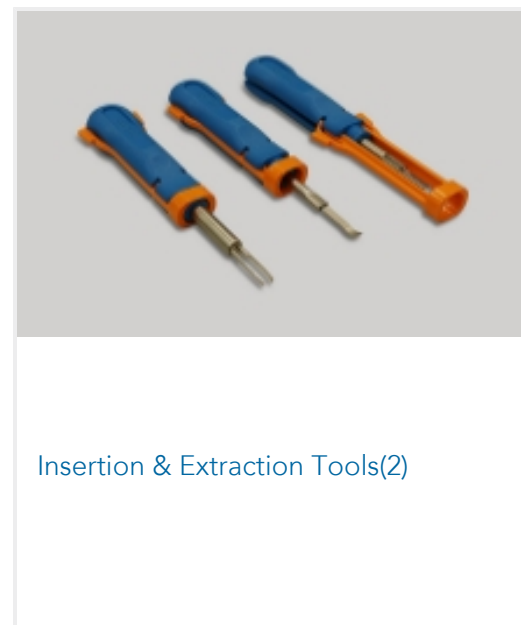
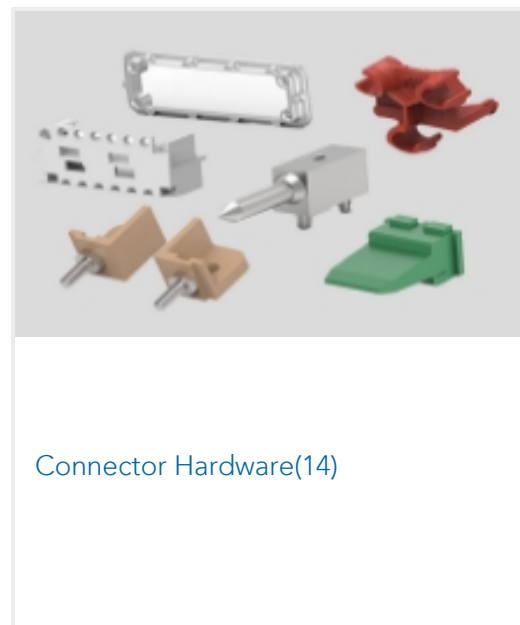
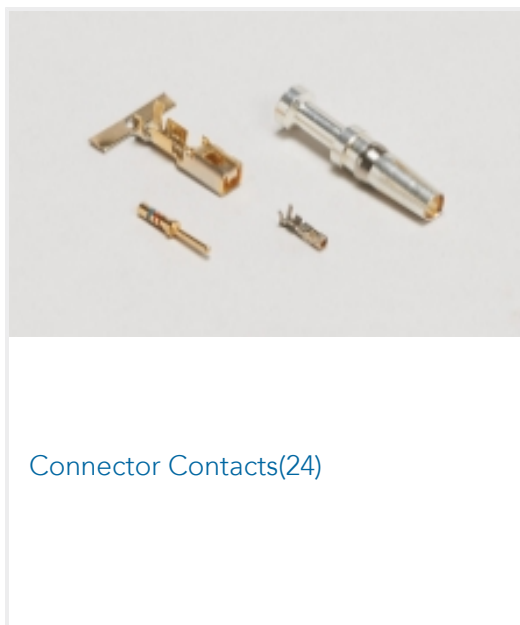

Customers Also Bought

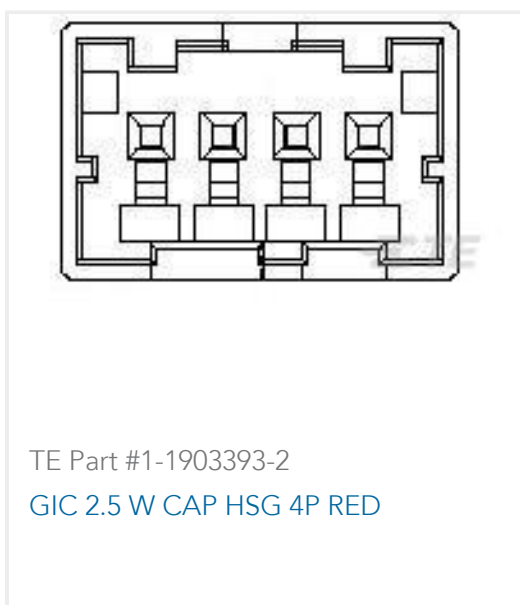

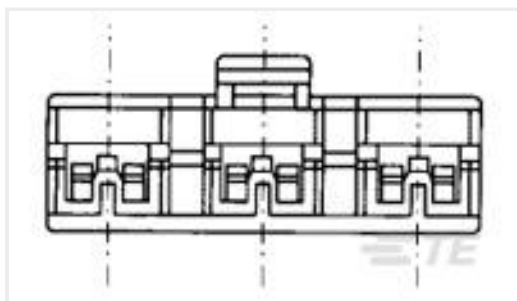

TE Part #353255-7
110 HSG. PL EX REC. 7.6mm 3P RED



TE Part #1-178708-1
187 SLEEV PL EX FLAG NAT

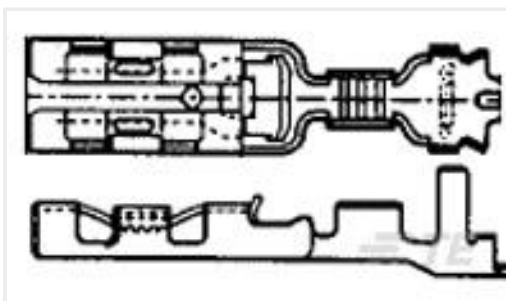

TE Part #353249-2
110 PL EX REC. 26-22AWG PTPHBZ

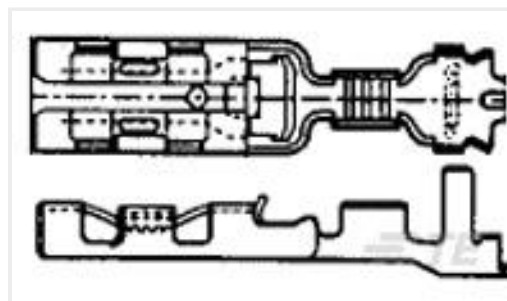

TE Part #353250-2
110 PL EX REC. 20-16AWG PTPHBZ

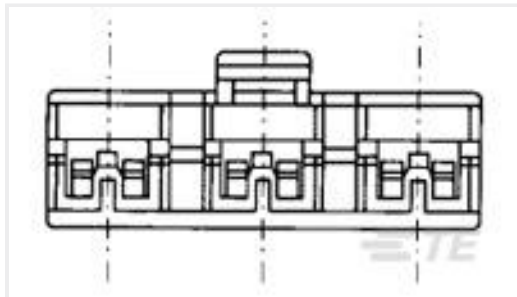

TE Part #353255-1
110 HSG. PL EX REC. 7.6mm 3P NAT



TE Part #5-1565089-1
GRACE INERTIA CONNECTOR 3.5 2P PLATE

Documents

Product Drawings

[AMP POWER D/LOCK PLUG HSG 6P](#)

English

CAD Files

[3D PDF](#)

3D

Customer View Model

[ENG_CVM_CVM_179862-1_N.2d_dxf.zip](#)

English

Customer View Model

[ENG_CVM_CVM_179862-1_N.3d_igs.zip](#)

English

Customer View Model

[ENG_CVM_CVM_179862-1_N.3d_stp.zip](#)

English

By downloading the CAD file I accept and agree to the [Terms and Conditions](#) of use.

Datasheets & Catalog Pages

[SOFT_SHELL_PIN_AND_SOCKET_CONNECTORS_CATALOG](#)

English

Product Specifications

[Application Specification](#)

English

Agency Approvals

[CSA Certificate](#)

179862-1

Housing, Plug, Wire-to-Board / Wire-to-Wire, 6 Position, 6.5 mm [.255 in] Centerline,
Wire & Cable, Power Double Lock, Rectangular Power Connectors



English