



TE Internal #: 160102-1

Closed Ring Tongue Terminal, 20 – 15 AWG, #10 Stud Size, 5.3 mm [.209 in] Stud Diameter, Open Barrel, Straight, Unplated, Uninsulated

[View on TE.com >](#)

Terminals & Splices > Ring Terminals

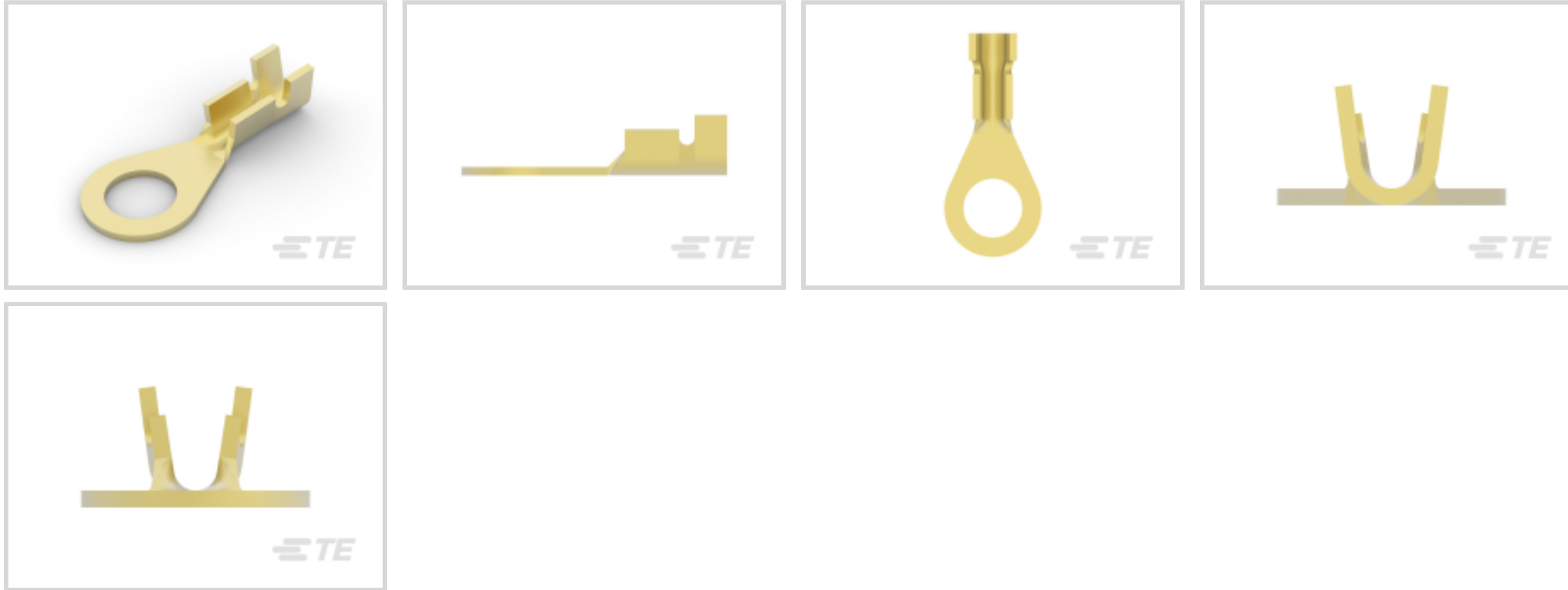

Ring Terminal Product Type: **Closed Ring Tongue Terminal**

Wire Size: **1021 – 3256 CMA**

Stud Size: **#10**

## Features

### Dimensions

	.08 in
Wire Size	1021 – 3256 CMA
Stud Diameter	5.3 mm [.209 in]
Tongue Thickness	.76 mm [.03 in]
Product Length	19.81 mm [.78 in]
Barrel Inside Diameter	1.65 mm, 2.28 mm [.065 in] [.09 in]
Compatible Insulation Diameter (Max)	3.05 mm [.12 in]
Compatible Insulation Diameter Range	2.03 – 3.05 mm [.08 – .12 in]

### Product Type Features

Ring Terminal Product Type	Closed Ring Tongue Terminal
Stud Size	#10
Sealable	No
Compatible With Discrete Wire Type	Stranded
Wire Insulation Support Retention Type	Insulation Support
Shape Description	Circular/Oval

### Contact Features



Barrel Type	Open
Terminal Orientation	Straight
Terminal Plating Material	Unplated
Contact Underplating Material	None
Contact Base Material	Brass

### Usage Conditions

Insulation Option	Uninsulated
Operating Temperature Range	-40 – 110 °C[-40 – 230 °F]

### Operation/Application

Compatible With Wire Base Material	Copper
------------------------------------	--------

### Packaging Features

Packaging Method	Strip/Reel
Packaging Quantity	6000

### Other

EU RoHS Compliance	Compliant
EU ELV Compliance	Compliant

### Body Features

Product Weight	.626 g
----------------	--------

### Mechanical Attachment

Wire Insulation Support	With
-------------------------	------

### Industry Standards

Government Qualified Terminal	No
-------------------------------	----

## Product Compliance

[For compliance documentation, visit the product page on TE.com>](#)

EU RoHS Directive 2011/65/EU	Compliant
EU ELV Directive 2000/53/EC	Compliant
China RoHS 2 Directive MIIT Order No 32, 2016	No Restricted Materials Above Threshold
EU REACH Regulation (EC) No. 1907/2006	Current ECHA Candidate List: JUNE 2024 (241) Candidate List Declared Against: JUNE 2024 (241) Does not contain REACH SVHC

Halogen Content	Low Halogen - Br, Cl, F, I < 900 ppm per homogenous material. Also BFR/CFR/PVC Free
Solder Process Capability	Not applicable for solder process capability



Product Compliance Disclaimer

This information is provided based on reasonable inquiry of our suppliers and represents our current actual knowledge based on the information they provided. This information is subject to change. The part numbers that TE has identified as EU RoHS compliant have a maximum concentration of 0.1% by weight in homogenous materials for lead, hexavalent chromium, mercury, PBB, PBDE, DBP, BBP, DEHP, DIBP, and 0.01% for cadmium, or qualify for an exemption to these limits as defined in the Annexes of Directive 2011/65/EU (RoHS2). Finished electrical and electronic equipment products will be CE marked as required by Directive 2011/65/EU. Components may not be CE marked. Additionally, the part numbers that TE has identified as EU ELV compliant have a maximum concentration of 0.1% by weight in homogenous materials for lead, hexavalent chromium, and mercury, and 0.01% for cadmium, or qualify for an exemption to these limits as defined in the Annexes of Directive 2000/53/EC (ELV). Regarding the REACH Regulation, the information TE provides on SVHC in articles for this part number is based on the latest European Chemicals Agency (ECHA) 'Guidance on requirements for substances in articles' posted at this URL: <https://echa.europa.eu/guidance-documents/guidance-on-reach>

### Compatible Parts

 <p>TE Part # 2150304-1 OCEAN_2.0_Applicator-E-110F140F-REM</p>	 <p><b>KIT</b> REPRESENTATION ONLY</p> <p>TE Part # 7-2150304-7 OCEAN_2.0_SPARE_PART_KIT-110F140F</p>	 <p>TE Part # 160668-6 TERMINAL</p>	 <p>TE Part # 2150304-2 OCEAN_2.0_Applicator-E-110F140F-REA</p>
--	--	--	--

### Customers Also Bought

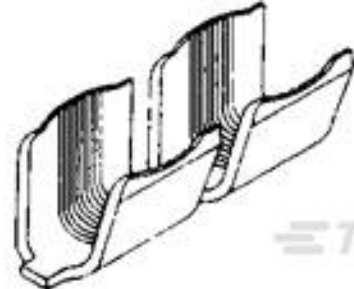
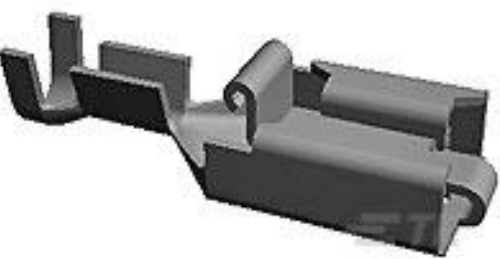
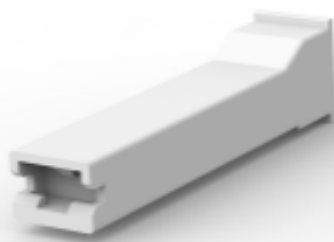
 <p>TE Part #160344-2 RING TONGUE 20-16 AWG .025 X .840</p>	 <p>TE Part #41456 RING TERMINAL 20-16 AWG TPBR</p>	 <p>TE Part #160102-2 RING TONGUE WITH IS 20-16 0.0253 TPBR</p>	 <p>TE Part #41765 SPLC AMVAR 1500-5000 020BR</p>
 <p>TE Part #928960-7 PL 250 REC TERMINAL 11-10 AWG PTPB</p>	 <p>TE Part #626036-2 RING TONGUE TERMINAL 4.0-6.0 MM2 TPBR</p>	 <p>TE Part #2232942-1 110 POS-LK MARK III NAT</p>	 <p>TE Part #3870023007 44A1111-16-9-9</p>

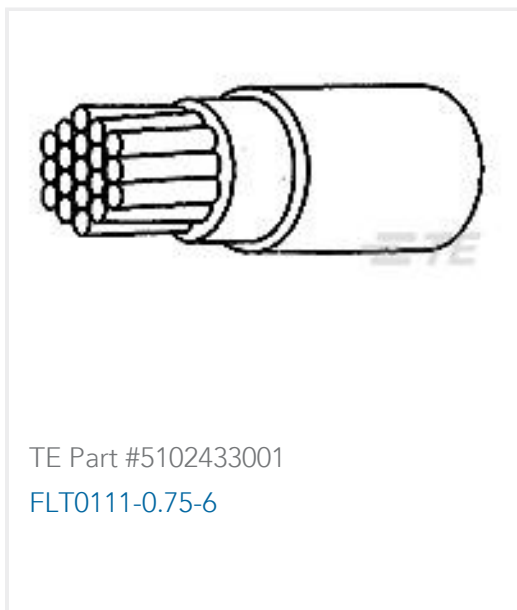

## Documents

### Product Drawings

[RING TONGUE WITH IS 20-16 AWG 0.0253 BR](#)

English

### CAD Files

[3D PDF](#)

3D

Customer View Model

[ENG\\_CVM\\_CVM\\_160102-1\\_AA.2d\\_dxf.zip](#)

English

Customer View Model

[ENG\\_CVM\\_CVM\\_160102-1\\_AA.3d\\_igs.zip](#)

English

Customer View Model

[ENG\\_CVM\\_CVM\\_160102-1\\_AA.3d\\_stp.zip](#)

English

By downloading the CAD file I accept and agree to the [Terms and Conditions](#) of use.

### Product Specifications

[Application Specification](#)

English