

2-917337-5 ✓ ACTIVE

[Dynamic Series](#) | [Dynamic 3000 Series](#)

TE Internal #: 2-917337-5

PCB Mount Header, Vertical, Wire-to-Board, 2 Position, 5.08 mm [.2 in] Centerline, Fully Shrouded, Tin, Through Hole - Solder, Dynamic 3000 Series

[View on TE.com >](#)



Connectors > PCB Connectors > PCB Headers & Receptacles > DYNAMIC 3200 HDR ASSY



EU RoHS Compliance: **Compliant**

EU ELV Compliance: **Compliant**

PCB Connector Assembly Type: **PCB Mount Header**

PCB Mount Orientation: **Vertical**

Connector System: **Wire-to-Board**

[All DYNAMIC 3200 HDR ASSY \(133\)](#)

Features

Other

EU RoHS Compliance **Compliant**

EU ELV Compliance **Compliant**

Product Type Features

PCB Connector Assembly Type **PCB Mount Header**

Connector System **Wire-to-Board**

Header Type **Fully Shrouded**

Sealable **No**

Connector & Contact Terminates To **Printed Circuit Board**

Configuration Features

PCB Mount Orientation **Vertical**

Number of Positions **2**

Number of Rows **1**



Body Features

Primary Product Color	Black
-----------------------	-------

Contact Features

Contact Mating Area Plating Material Finish	Matte
Contact Mating Area Plating Material Thickness	2 µm[80 µin]
Contact Mating Area Plating Material	Tin
Contact Type	Pin
Contact Current Rating (Max)	15 A

Termination Features

Termination Method to PCB	Through Hole - Solder
---------------------------	-----------------------

Mechanical Attachment

Mating Retention	With
PCB Mount Retention Type	Retention Leg
Mating Alignment Type	Keyed
PCB Mount Alignment Type	Solder Peg
PCB Mount Retention	With
PCB Mount Alignment	Without
Connector Mounting Type	Board Mount
Mating Alignment	With

Housing Features

Housing Material	Polyester GF
Centerline (Pitch)	5.08 mm [.2 in]

Usage Conditions

Operating Temperature Range	-55 – 105 °C[-67 – 221 °F]
-----------------------------	----------------------------

Industry Standards

UL Flammability Rating	UL 94V-0
------------------------	----------

Packaging Features

Packaging Method	Tube, Box
------------------	-----------

Product Compliance

For compliance documentation, visit the product page on [TE.com](#)>

EU RoHS Directive 2011/65/EU	Compliant
------------------------------	-----------



EU ELV Directive 2000/53/EC	Compliant
China RoHS 2 Directive MIIT Order No 32, 2016	No Restricted Materials Above Threshold
EU REACH Regulation (EC) No. 1907/2006	Current ECHA Candidate List: JUNE 2024 (241) Candidate List Declared Against: JUNE 2024 (241) Does not contain REACH SVHC
Halogen Content	Not Low Halogen - contains Br or Cl > 900 ppm.
Solder Process Capability	Wave solder capable to 265°C

Product Compliance Disclaimer

This information is provided based on reasonable inquiry of our suppliers and represents our current actual knowledge based on the information they provided. This information is subject to change. The part numbers that TE has identified as EU RoHS compliant have a maximum concentration of 0.1% by weight in homogenous materials for lead, hexavalent chromium, mercury, PBB, PBDE, DBP, BBP, DEHP, DIBP, and 0.01% for cadmium, or qualify for an exemption to these limits as defined in the Annexes of Directive 2011/65/EU (RoHS2). Finished electrical and electronic equipment products will be CE marked as required by Directive 2011/65/EU. Components may not be CE marked. Additionally, the part numbers that TE has identified as EU ELV compliant have a maximum concentration of 0.1% by weight in homogenous materials for lead, hexavalent chromium, and mercury, and 0.01% for cadmium, or qualify for an exemption to these limits as defined in the Annexes of Directive 2000/53/EC (ELV). Regarding the REACH Regulation, the information TE provides on SVHC in articles for this part number is based on the latest European Chemicals Agency (ECHA) 'Guidance on requirements for substances in articles' posted at this URL: <https://echa.europa.eu/guidance-documents/guidance-on-reach>

Compatible Parts



Also in the Series | Dynamic 3000 Series

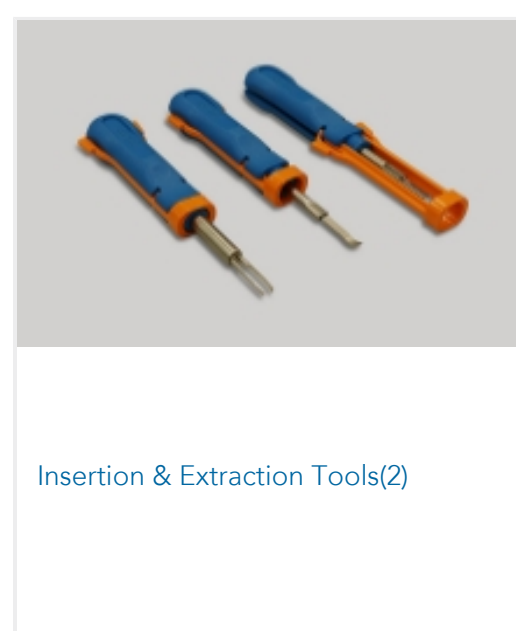
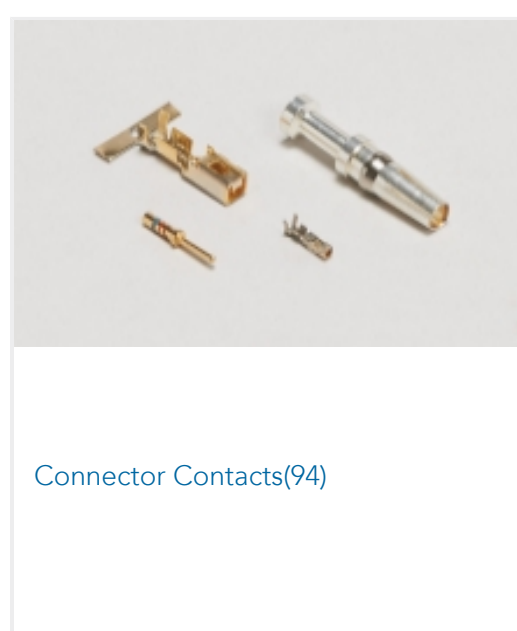

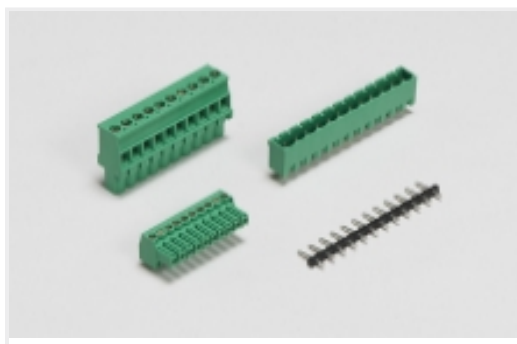

PCB Terminal Blocks(37)

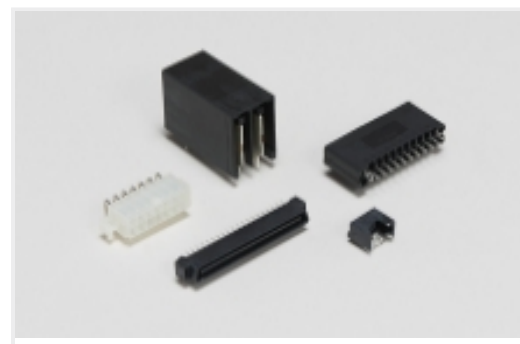

Standard Rectangular Connectors(2)

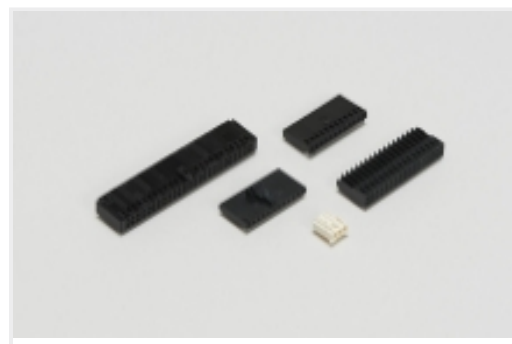

Wire-to-Board Connector Assemblies & Housings(152)

Customers Also Bought

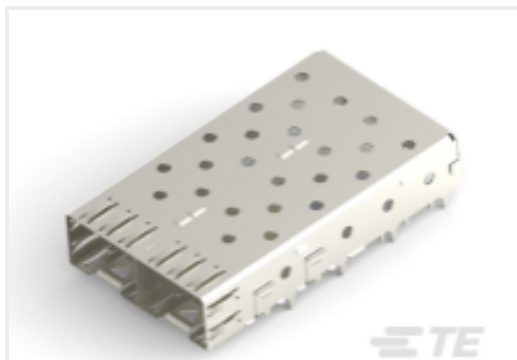
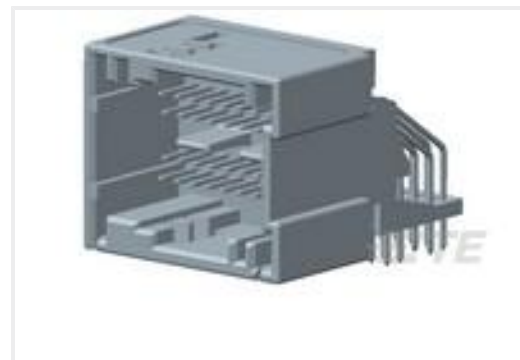
TE Part #178327-5
DYNAMIC D/ROW HDR 16P V ASSYTE Part #10142048-31
HTU31V I.C 31V RH/T ANALOG R1500TE Part #643234-1
06P UMNL HDR ASSY R/A 94VOTE Part #350760-4
03P UMNL HDR ASSY PCTE Part #1761014-3
SFP 1X2 CAGE ASSY, PRESS FITTE Part #1745060-1
40pos MQS .63 header 90degTE Part #384583-E
STVB 64 M AB VV 4-00 0606 * 8040 247 E00TE Part #5536475-1
ASSY,PIN,EUROCARD,TYPE C,LEAD-FREE,96 PO

Documents

Product Drawings

[DYNAMIC D-3 VERTI. HDR ASSY 2P](#)

English

CAD Files

Customer View Model

[ENG_CVM_CVM_2-917337-5_C2.3d_igs.zip](#)

English

Customer View Model

[ENG_CVM_CVM_2-917337-5_C2.3d_stp.zip](#)

English

Customer View Model

[ENG_CVM_CVM_2-917337-5_C2.2d_dxf.zip](#)

English

3D PDF

3D

By downloading the CAD file I accept and agree to the [Terms and Conditions](#) of use.



Product Specifications

Product Specification

English

Agency Approvals

TUV Certificate

English