

1563126-1 ✓ ACTIVE

AMP | MCON 1.2mm, MCON Interconnection System

TE Internal #: 1563126-1

TPA (Terminal Position Assurance), Red, PBT GF, MCON Interconnection System, Automotive Connector Locks & Position Assurance

[View on TE.com >](#)



Connectors > Automotive Connectors > Automotive Connector Accessories > Automotive Connector Locks & Position Assurance

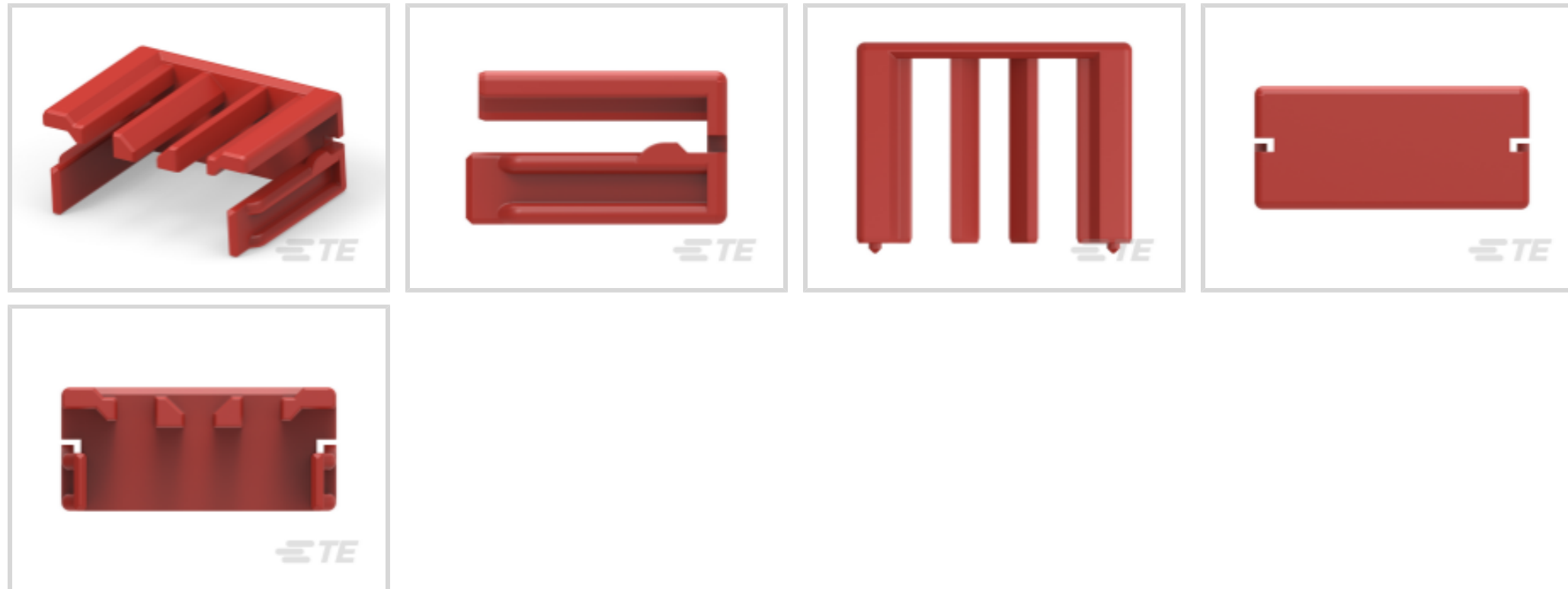

Connector & Contact Retention Accessory Type: **TPA (Terminal Position Assurance)**

Primary Product Color: **Red**

Primary Product Material: **PBT GF**

Operating Temperature Range: **-40 – 140 °C [-40 – 284 °F]**

EU RoHS Compliance: **Compliant**

Features

Product Type Features

Connector & Contact Retention Accessory Type	TPA (Terminal Position Assurance)
--	-----------------------------------

Body Features

Primary Product Color	Red
Primary Product Material	PBT GF

Usage Conditions

Operating Temperature Range	-40 – 140 °C [-40 – 284 °F]
-----------------------------	-------------------------------

Other

EU RoHS Compliance	Compliant
EU ELV Compliance	Compliant
Serviceable	Yes

Industry Standards

UL Flammability Rating	UL 94HB
------------------------	---------



Product Compliance

[For compliance documentation, visit the product page on TE.com>](#)

EU RoHS Directive 2011/65/EU	Compliant
EU ELV Directive 2000/53/EC	Compliant
China RoHS 2 Directive MIIT Order No 32, 2016	No Restricted Materials Above Threshold
EU REACH Regulation (EC) No. 1907/2006	Current ECHA Candidate List: JUNE 2024 (241) Candidate List Declared Against: JUNE 2024 (241) Does not contain REACH SVHC
Halogen Content	BFR/CFR/PVC Free, but Br/Cl >900 ppm in other sources.
Solder Process Capability	Not applicable for solder process capability

Product Compliance Disclaimer

This information is provided based on reasonable inquiry of our suppliers and represents our current actual knowledge based on the information they provided. This information is subject to change. The part numbers that TE has identified as EU RoHS compliant have a maximum concentration of 0.1% by weight in homogenous materials for lead, hexavalent chromium, mercury, PBB, PBDE, DBP, BBP, DEHP, DIBP, and 0.01% for cadmium, or qualify for an exemption to these limits as defined in the Annexes of Directive 2011/65/EU (RoHS2). Finished electrical and electronic equipment products will be CE marked as required by Directive 2011/65/EU. Components may not be CE marked. Additionally, the part numbers that TE has identified as EU ELV compliant have a maximum concentration of 0.1% by weight in homogenous materials for lead, hexavalent chromium, and mercury, and 0.01% for cadmium, or qualify for an exemption to these limits as defined in the Annexes of Directive 2000/53/EC (ELV). Regarding the REACH Regulation, the information TE provides on SVHC in articles for this part number is based on the latest European Chemicals Agency (ECHA) 'Guidance on requirements for substances in articles' posted at this URL: <https://echa.europa.eu/guidance-documents/guidance-on-reach>

Compatible Parts



Also in the Series | [MCON 1.2mm](#)

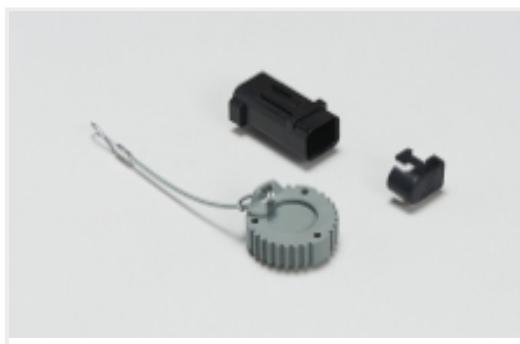

Automotive Connector Caps & Covers (18)

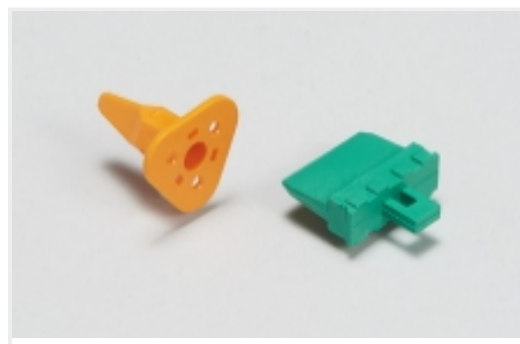

Automotive Connector Locks & Position Assurance(10)

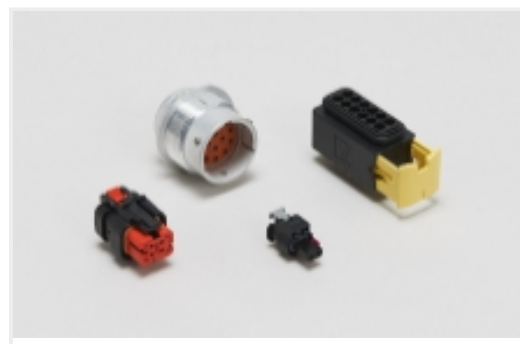

Automotive Housings(324)

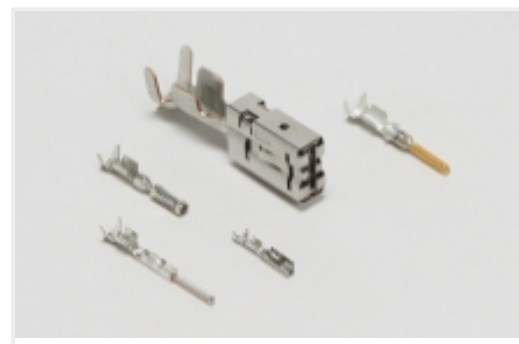

Automotive Terminals(93)



Connector Seals & Cavity Plugs(13)

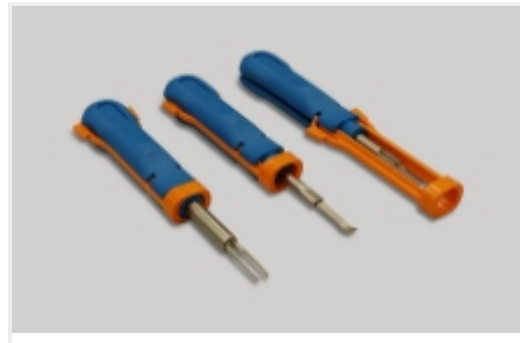

Insertion & Extraction Tools(5)

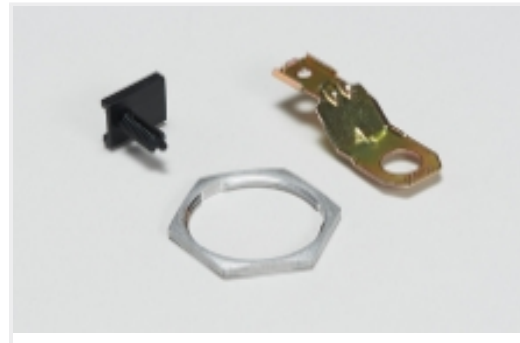

Other Automotive Connector Accessories(7)

Also in the Series | MCON Interconnection System



Automotive Connector Caps & Covers (36)

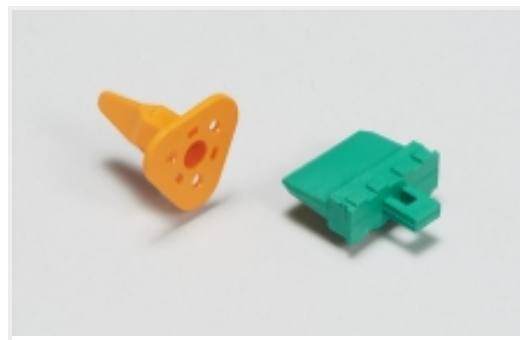

Automotive Connector Locks & Position Assurance(15)

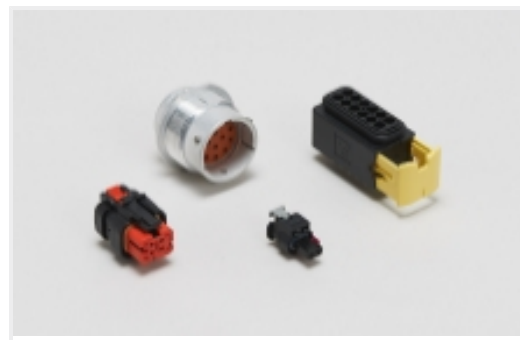

Automotive Housings(119)

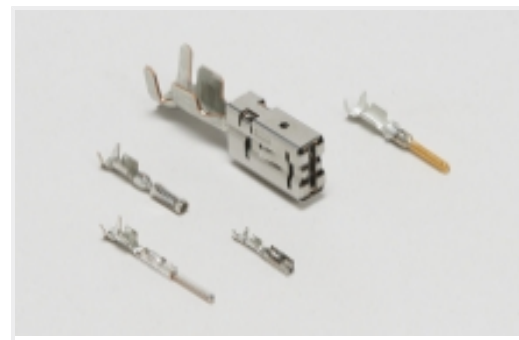

Automotive Terminals(23)



Connector Seals & Cavity Plugs(8)

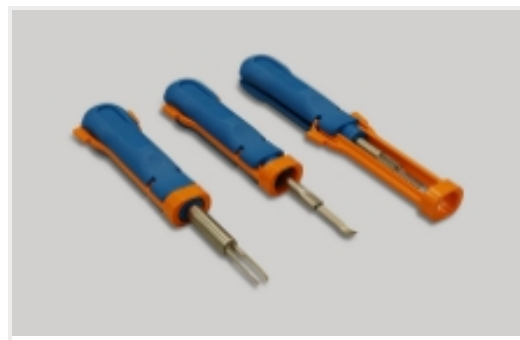

Insertion & Extraction Tools(31)

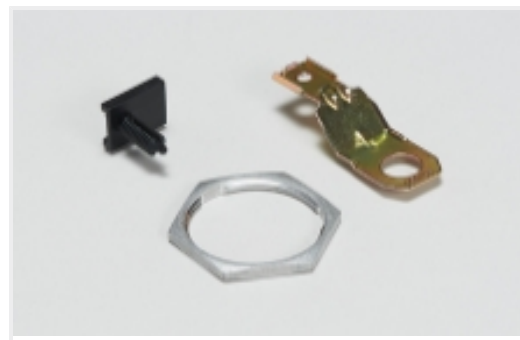

Other Automotive Connector Accessories(4)

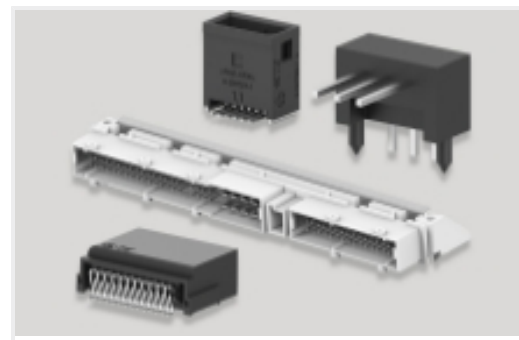

PCB Headers & Receptacles(4)

Customers Also Bought

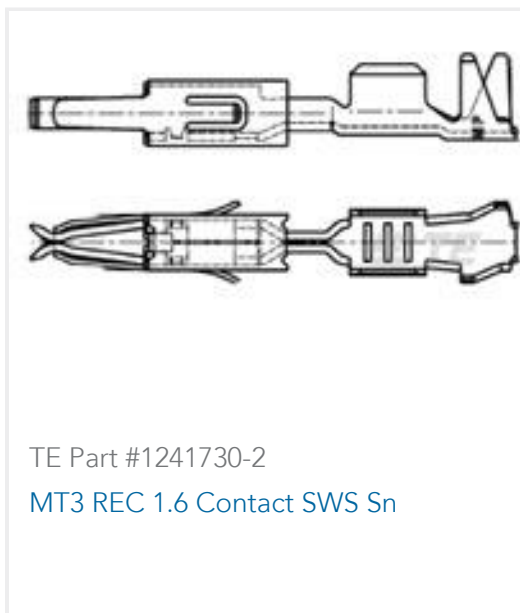

TE Part #1241730-2
MT3 REC 1.6 Contact SWS Sn



TE Part #5-1418760-1
MCON 1.2 LL TAB STC SN



TE Part #1-2177908-1
MCON 0.50 TERMINAL



TE Part #5-968220-5
MQS0,63 Au rec CB unseal. 0,2-0,35



TE Part #1-2236269-1
24POS, MIXED, REC HSG,
20GENYMCP, ASSY, CODA



TE Part #1-2236269-2
24POS, MIXED, REC HSG,
20GENYMCP, ASSY, CODB



TE Part #1418789-1
8POS MQS REC



TE Part #2177000-1
10POS, 0.64 GENER. Y, REC HSG, ASSY



TE Part #2236060-1
COVER, ASSY



TE Part #2112674-2
37POS MIXED MQS REC COD B

Documents

Product Drawings

2. LOCK, 10 POS MALE HOUSING

English

CAD Files

3D PDF

3D

Customer View Model

[ENG_CVM_CVM_1563126-1_A.2d_dxf.zip](#)

English

Customer View Model

[ENG_CVM_CVM_1563126-1_A.3d_igs.zip](#)

English

Customer View Model

[ENG_CVM_CVM_1563126-1_A.3d_stp.zip](#)

English

By downloading the CAD file I accept and agree to the [Terms and Conditions](#) of use.

Product Specifications



Application Specification

English