

1-967624-1 ✓ ACTIVE

AMP | Junior Power Timer

TE Internal #: 1-967624-1

Housing for Female Terminals, Wire-to-Board / Wire-to-Wire, 18 Position, 5 mm [.197 in] Centerline, Gray, Wire & Cable, Signal, Junior Power Timer

[View on TE.com >](#)



Connectors > Automotive Connectors > Automotive Housings > Timer Connector Housing



Connector System: **Wire-to-Board, Wire-to-Wire**

Number of Positions: **18**

Connector & Housing Type: **Housing for Female Terminals**

Centerline (Pitch): **5 mm [.197 in]**

Sealable: **No**

[All Timer Connector Housing \(497\)](#)

Features

Product Type Features

Connector System	Wire-to-Board, Wire-to-Wire
Connector & Housing Type	Housing for Female Terminals
Sealable	No
Connector & Contact Terminates To	Wire & Cable
Primary Locking Feature	On the Terminal
Mixed & Hybrid Connector	No
Connector Shape	Rectangular

Configuration Features

Number of Positions	18
Number of Rows	3

Housing Features

Centerline (Pitch)	5 mm [.197 in]
Housing Material	PBT GF

Contact Features

Mating Tab Width	2.8 mm [.11 in]
Contact Current Rating (Max)	30 A
Contact Size	2.8mm



Contact Type	Receptacle
--------------	------------

Body Features

Primary Product Color	Gray
Connector & Keying Code	A

Operation/Application

Circuit Application	Signal
---------------------	--------

Mechanical Attachment

Connector Mounting Type	Cable Mount (Free-Hanging)
Strain Relief	Without
Terminal Position Assurance	Yes
Mating Alignment Type	Keyed
Mating Alignment	With

Usage Conditions

Operating Temperature (Max)	100 °C[212 °F]
Operating Temperature Range	-30 – 100 °C[-22 – 212 °F]

Electrical Characteristics

Nominal Voltage Architecture	28 V
------------------------------	------

Other

Connector Position Assurance Capable	No
EU RoHS Compliance	Compliant
EU ELV Compliance	Compliant
Serviceable	No

Dimensions

Product Length	34.8 mm[1.37 in]
Connector Height	26.5 mm[1.043 in]

Packaging Features

Packaging Method	Carton
------------------	--------

Product Compliance

[For compliance documentation, visit the product page on TE.com>](#)

EU RoHS Directive 2011/65/EU	Compliant
------------------------------	-----------



EU ELV Directive 2000/53/EC

Compliant

China RoHS 2 Directive MIIT Order No 32, 2016

No Restricted Materials Above Threshold

EU REACH Regulation (EC) No. 1907/2006

Current ECHA Candidate List: JUNE 2024 (241)

Candidate List Declared Against: JUNE 2024 (241)

Does not contain REACH SVHC

Halogen Content

Low Halogen - Br, Cl, F, I < 900 ppm per homogenous material. Also BFR/CFR/PVC Free

Solder Process Capability

Not applicable for solder process capability

Product Compliance Disclaimer

This information is provided based on reasonable inquiry of our suppliers and represents our current actual knowledge based on the information they provided. This information is subject to change. The part numbers that TE has identified as EU RoHS compliant have a maximum concentration of 0.1% by weight in homogenous materials for lead, hexavalent chromium, mercury, PBB, PBDE, DBP, BBP, DEHP, DIBP, and 0.01% for cadmium, or qualify for an exemption to these limits as defined in the Annexes of Directive 2011/65/EU (RoHS2). Finished electrical and electronic equipment products will be CE marked as required by Directive 2011/65/EU. Components may not be CE marked. Additionally, the part numbers that TE has identified as EU ELV compliant have a maximum concentration of 0.1% by weight in homogenous materials for lead, hexavalent chromium, and mercury, and 0.01% for cadmium, or qualify for an exemption to these limits as defined in the Annexes of Directive 2000/53/EC (ELV). Regarding the REACH Regulation, the information TE provides on SVHC in articles for this part number is based on the latest European Chemicals Agency (ECHA) 'Guidance on requirements for substances in articles' posted at this URL: <https://echa.europa.eu/guidance-documents/guidance-on-reach>

Compatible Parts



TE Part # 967634-1
2. RETAINER FOR 18POS



TE Part # CAT-T4827-CH8172
Timer Connector Housing



TE Part # 1-967629-1
FLA-STE-GEH2,8 18P



TE Part # CAT-M4599-H342
AMP MCP Unsealed Headers



TE Part # CAT-T4827-T273
TIMER, RECEPTACLE AND TAB



TE Part # 3-966140-5
MESSERLEISTE 6P



TE Part # 1-967629-0
TAB HOUSING, 2.8MM, 18POS.



TE Part # 1719810-1
JPT REC 2.8 Contact SRC Sn

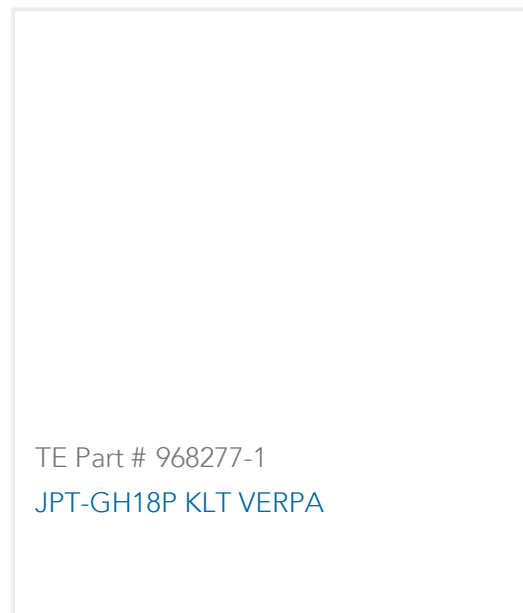

Also in the Series | Junior Power Timer



Automotive Connector Caps & Covers (9)

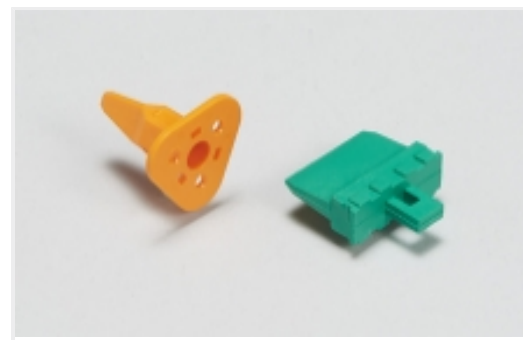

Automotive Connector Locks & Position Assurance (8)

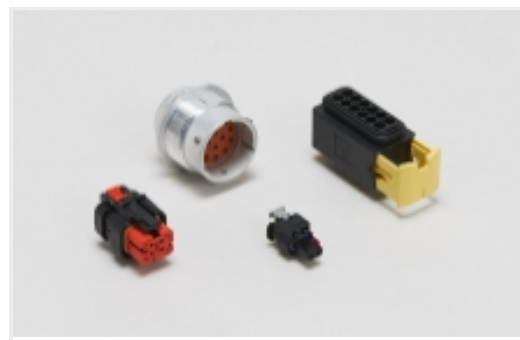

Automotive Housings (306)

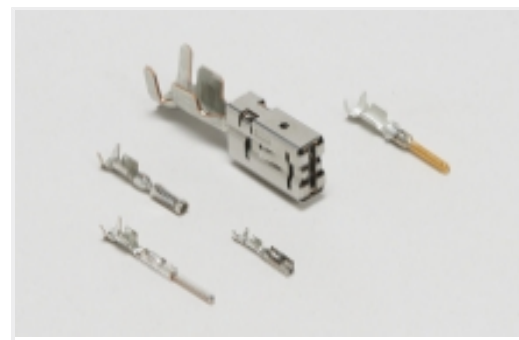

Automotive Terminals (153)



Busbars & Terminals (1)



Connector Seals & Cavity Plugs (8)



Insertion & Extraction Tools (8)

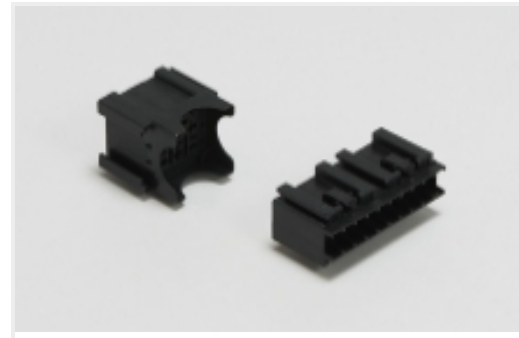

Module Components (1)

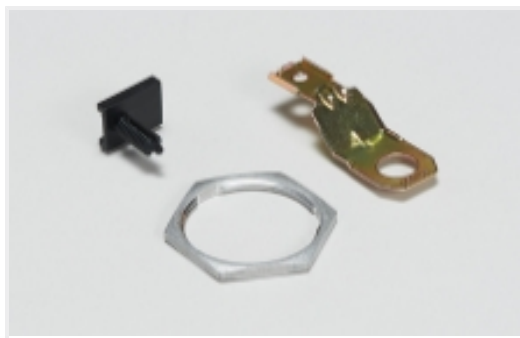

Other Automotive Connector Accessories (2)



Special Purpose Terminals (2)

Customers Also Bought



TE Part #1-967625-2
Timer Connector Housing

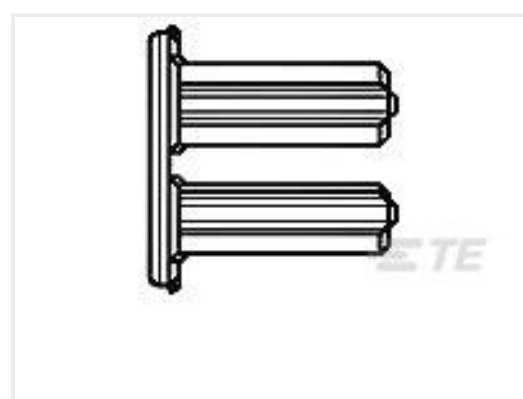

TE Part #968271-1
2. KONT-SICHERUNG 6P



TE Part #1-967630-1
FLA STEGEHZ



Documents

Product Drawings

[JUN-POW-TIM HOUSING 18POS](#)

English

CAD Files

[3D PDF](#)

3D

Customer View Model

[ENG_CVM_CVM_1-967624-1_C.2d_dxf.zip](#)

English

Customer View Model

[ENG_CVM_CVM_1-967624-1_C.3d_igs.zip](#)

English

Customer View Model

[ENG_CVM_CVM_1-967624-1_C.3d_stp.zip](#)

English

By downloading the CAD file I accept and agree to the [Terms and Conditions](#) of use.

Product Specifications

[Product Specification](#)

English

[Product Specification](#)

English