

DTM04-08PB ✓ ACTIVE

DEUTSCH | DEUTSCH DT, DEUTSCH DTM

TE Internal #: DTM04-08PB

Housing for Male Terminals, Wire-to-Wire, 8 Position, 4.19 mm [.165 in] Centerline, Sealable, Black, Wire & Cable, Power, Hybrid

[View on TE.com >](#)



Connectors > Automotive Connectors > Automotive Housings > DEUTSCH DTM Housings



Connector System: **Wire-to-Wire**

Number of Positions: **8**

Connector & Housing Type: **Housing for Male Terminals**

Centerline (Pitch): **4.19 mm [.165 in]**

Sealable: **Yes**

[All DEUTSCH DTM Housings \(113\)](#)

Features

Product Type Features

Connector System	Wire-to-Wire
Connector & Housing Type	Housing for Male Terminals
Sealable	Yes
Connector & Contact Terminates To	Wire & Cable
Primary Locking Feature	Integrated in Housing
Mixed & Hybrid Connector	No
Connector Shape	Rectangular

Configuration Features

Number of Positions	8
Number of Rows	2
Blank Cavity Position	0
Connector Seal Code	N Seal

Housing Features



Centerline (Pitch)	4.19 mm [.165 in]
--------------------	-------------------

Housing Material	PA 66 GF15
------------------	------------

Contact Features

Mating Pin Diameter	1 mm [.04 in]
---------------------	---------------

Contact Current Rating (Max)	7.5 A
------------------------------	-------

Contact Size	Size 20
--------------	---------

Contact Type	Pin
--------------	-----

Body Features

Primary Product Color	Black
-----------------------	-------

Connector & Keying Code	B
-------------------------	---

Cable Exit Angle	180°
------------------	------

Operation/Application

Circuit Application	Power
---------------------	-------

Mechanical Attachment

Connector Mounting Type	Cable Mount (Free-Hanging)
-------------------------	----------------------------

Terminal Position Assurance	Yes
-----------------------------	-----

Mating Alignment Type	Keyed
-----------------------	-------

Mating Alignment	With
------------------	------

Usage Conditions

Operating Temperature (Max)	125 °C [257 °F]
-----------------------------	-----------------

Operating Temperature Range	-55 – 125 °C [-67 – 257 °F]
-----------------------------	-----------------------------

Electrical Characteristics

Nominal Voltage Architecture	250 V
------------------------------	-------

Operating Voltage	250 VDC
-------------------	---------

Other

Connector Position Assurance Capable	No
--------------------------------------	----

EU RoHS Compliance	Compliant
--------------------	-----------

EU ELV Compliance	Compliant
-------------------	-----------

Serviceable	Yes
-------------	-----

Dimensions

Row-to-Row Spacing	7.11 mm [.28 in]
--------------------	------------------

Compatible Insulation Diameter Range	1.35 – 3.05 mm [.053 – .12 in]
--------------------------------------	--------------------------------



Product Width	20.22 mm[.796 in]
Product Length	43.69 mm[1.72 in]
Connector Height	31.62 mm[1.245 in]

Industry Standards

IP Rating	IP6K9K, IP68
Compatible With Agency/Standards Products	SAE J2030
UL Flammability Rating	UL 94V-0

Packaging Features

Packaging Quantity	500
Packaging Method	Package

Product Compliance

[For compliance documentation, visit the product page on TE.com>](#)

EU RoHS Directive 2011/65/EU	Compliant
EU ELV Directive 2000/53/EC	Compliant
China RoHS 2 Directive MIIT Order No 32, 2016	No Restricted Materials Above Threshold
EU REACH Regulation (EC) No. 1907/2006	Current ECHA Candidate List: JUNE 2024 (241) Candidate List Declared Against: JUNE 2024 (241) SVHC > Threshold: Octamethylcyclotetrasiloxane (D4) (.5% in Component Part) Dodecamethylcyclohexasiloxane (D6) (.5% in Component Part) Decamethylcyclopentasiloxane (D5) (.5% in Component Part) Article Safe Usage Statements: Wash thoroughly after handling. Recycle if possible and dispose of the article by following all applicable governmental regulations relevant to your geographic location.
Halogen Content	Not Low Halogen - contains Br or Cl > 900 ppm.
Solder Process Capability	Not reviewed for solder process capability

Product Compliance Disclaimer

This information is provided based on reasonable inquiry of our suppliers and represents our current actual knowledge based on the information they provided. This information is subject to change. The part numbers that TE has identified as EU RoHS compliant have a maximum concentration of 0.1% by weight in homogenous materials for lead, hexavalent chromium, mercury, PBB, PBDE, DBP, BBP, DEHP, DIBP, and 0.01% for cadmium, or qualify for an exemption to these limits as defined in the Annexes of Directive 2011/65/EU (RoHS2). Finished electrical and electronic equipment products will be CE marked as required by Directive 2011/65/EU. Components may not be CE marked. Additionally, the part numbers that TE has identified as EU ELV compliant have a maximum concentration of 0.1% by weight in homogenous

materials for lead, hexavalent chromium, and mercury, and 0.01% for cadmium, or qualify for an exemption to these limits as defined in the Annexes of Directive 2000/53/EC (ELV). Regarding the REACH Regulation, the information TE provides on SVHC in articles for this part number is based on the latest European Chemicals Agency (ECHA) 'Guidance on requirements for substances in articles' posted at this URL: <https://echa.europa.eu/guidance-documents/guidance-on-reach>

Compatible Parts

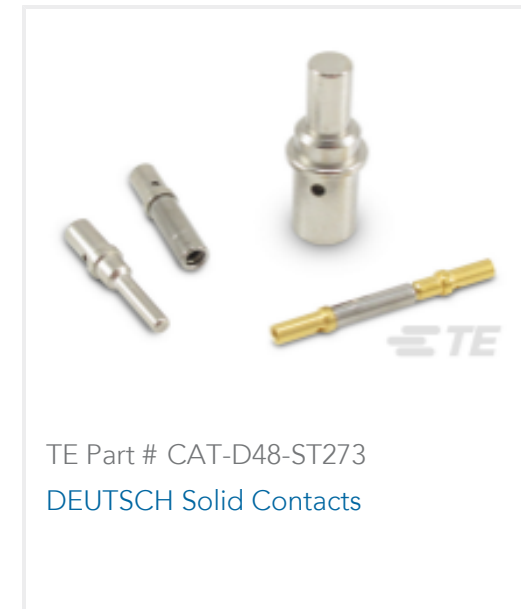

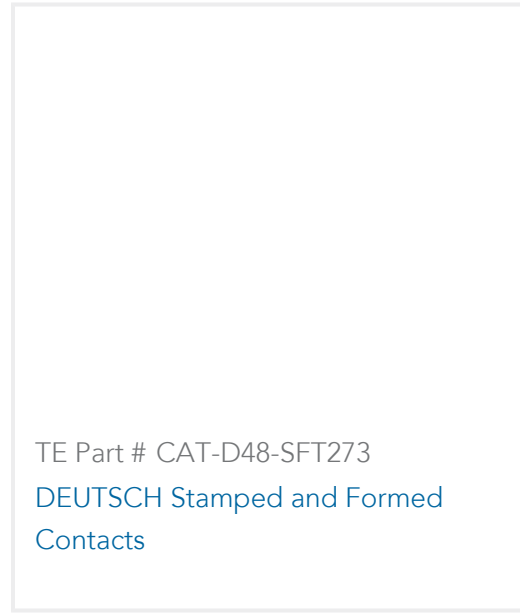

Also in the Series | DEUTSCH DT

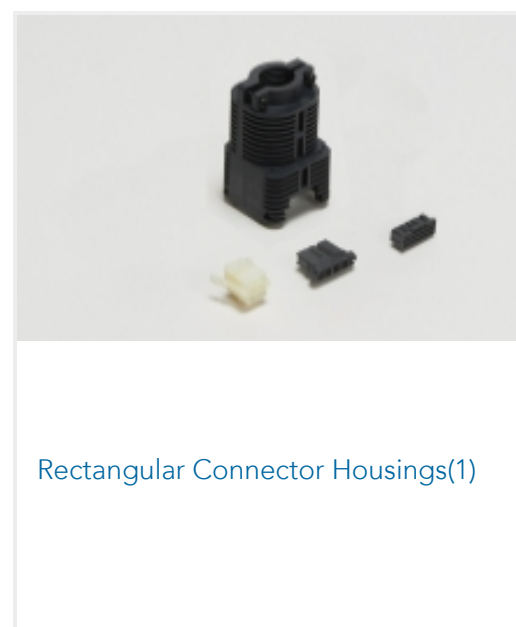
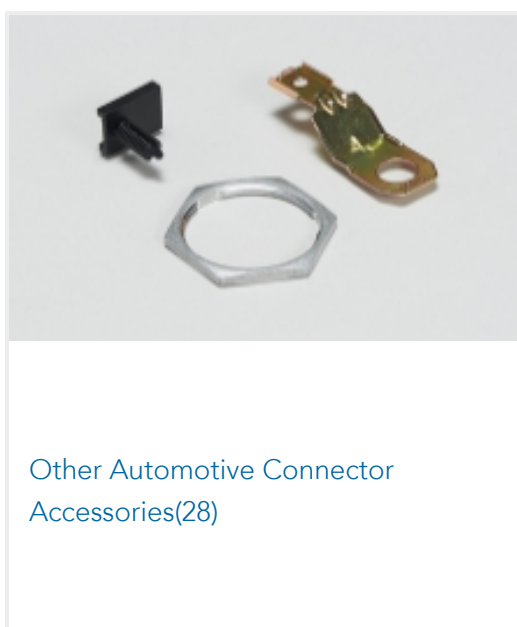
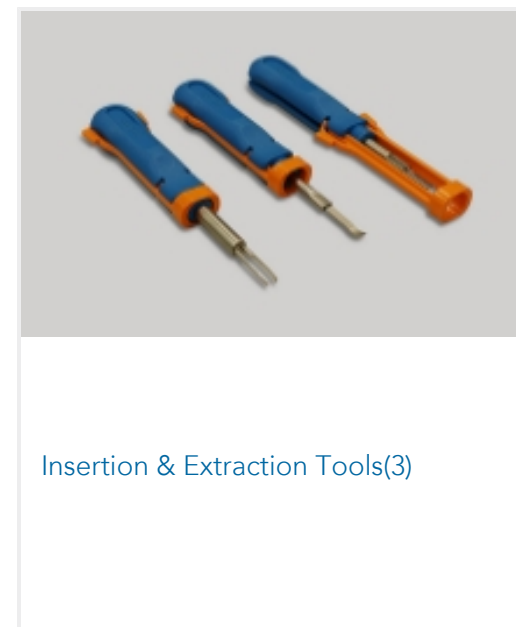
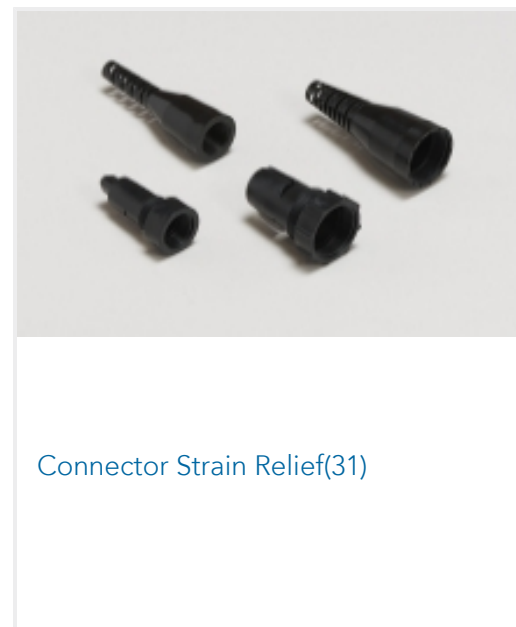
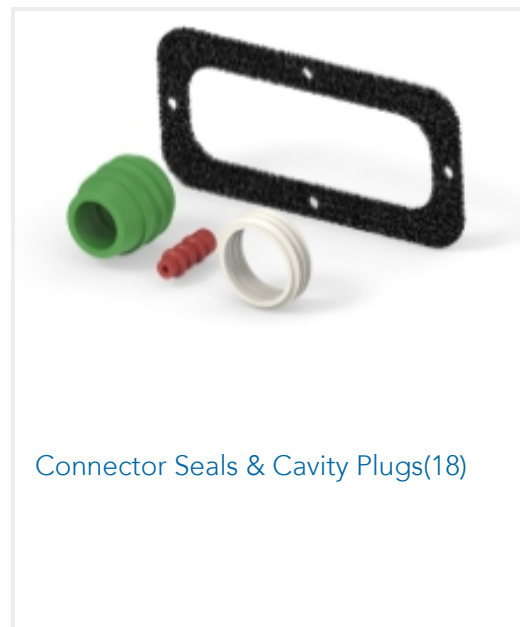
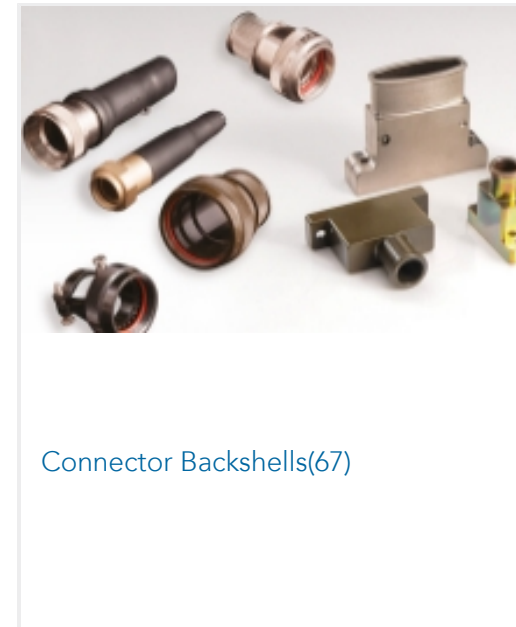
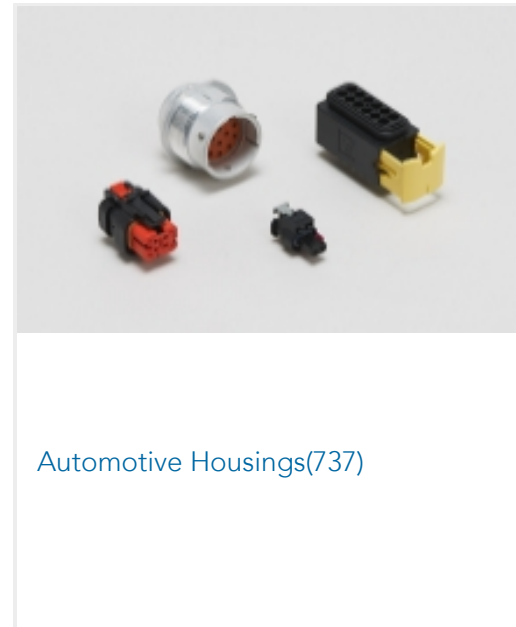
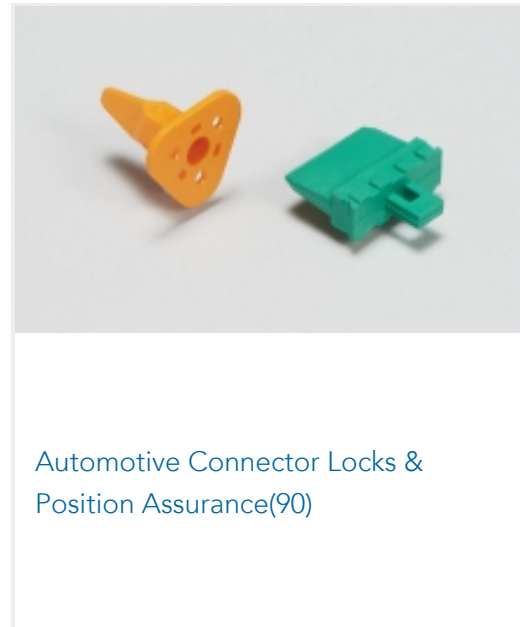

Also in the Series | DEUTSCH DTM



Automotive Connector Caps & Covers (7)

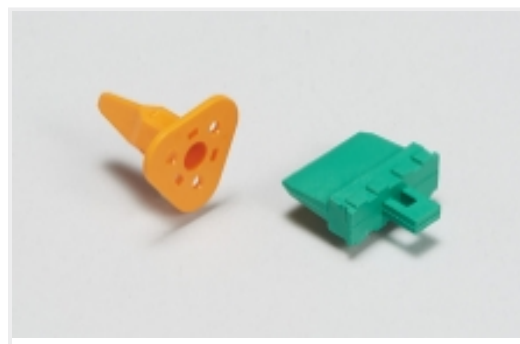

Automotive Connector Locks & Position Assurance(26)

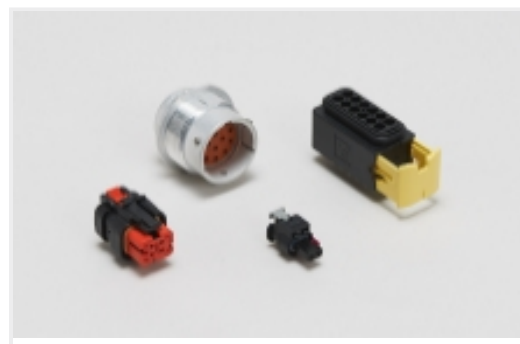

Automotive Housings(109)



Connector Backshells(7)



Connector Seals & Cavity Plugs(1)



Connector Strain Relief(28)



Insertion & Extraction Tools(2)

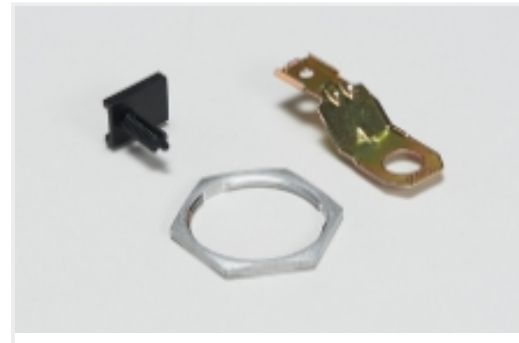

Other Automotive Connector Accessories(7)

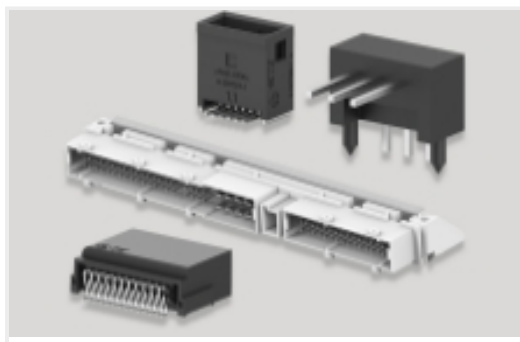

PCB Headers & Receptacles(38)

Customers Also Bought



TE Part #DTM06-08SA
DEUTSCH DTM Housings



TE Part #WM-8S
DEUTSCH DTM Wedgelocks



TE Part #1027-003-1200
CLIP, SS, 11MM HOLE, ST



TE Part #DTM04-3P-R011
REC, 3P, BLK, 90DEG, PANEL

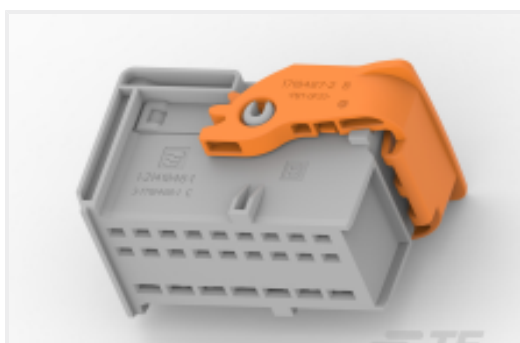

TE Part #1-2141846-2
CARRIER,RECEPTACLE HSG, 25POS, ASSY



TE Part #DTM8S-BT-BK
BOOT, 8P, PLG, ST, BLK

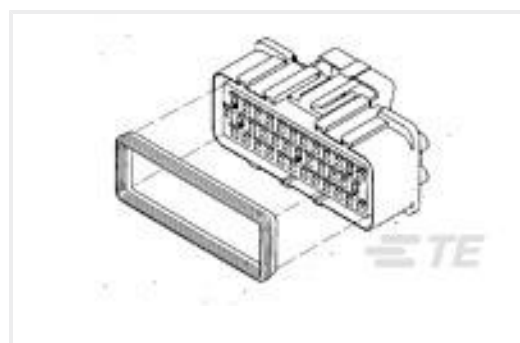

TE Part #346189-5
36 WAY REC HSG ASSY RED 60P P

Documents



Product Drawings

[REC, 8P, BLK, N, B](#)

English

CAD Files

[3D PDF](#)

3D

Customer View Model

[ENG_CVM_CVM_DTM04-08PB_99_c-dtm04-08pb-99.2d_dxf.zip](#)

English

Customer View Model

[ENG_CVM_CVM_DTM04-08PB_99_c-dtm04-08pb-99.3d_igs.zip](#)

English

Customer View Model

[ENG_CVM_CVM_DTM04-08PB_99_c-dtm04-08pb-99.3d_stp.zip](#)

English

By downloading the CAD file I accept and agree to the [Terms and Conditions](#) of use.

Datasheets & Catalog Pages

[TERMINALS AND CONNECTORS](#)

English

[ICT Terminals and Connectors Catalogue](#)

English

[CONNECTOR SELECTOR](#)

English

Product Specifications

[Application Specification](#)

English

Agency Approvals

[UL Report](#)

English