

60618-5 ✓ ACTIVE

MATE-N-LOK | Commercial MATE-N-LOK

TE Internal #: 60618-5

Pin Contact, Gold, 250 VAC, Locking Lance Contact Retention, 24 – 18 AWG Wire Size, .2 – .82 mm<sup>2</sup> Wire Size, Crimp, Brass, Power, Commercial MATE-N-LOK

[View on TE.com >](#)



Connectors > Contacts > Connector Contacts



Contact Type: **Pin**

Contact Mating Area Plating Material: **Gold**

Wire Contact Termination Area Plating Material: **Gold**

Operating Voltage: **250 VAC**

Contact Retention Within Housing: **With**

## Features

### Product Type Features

Discrete Wire Type	Stranded
--------------------	----------

### Packaging Features

Packaging Quantity	1000
Packaging Method	Bag

### Dimensions

Compatible Insulation Diameter Range	2.54 mm[.1 in]
Wire Size	.2 – .82 mm <sup>2</sup>

### Mechanical Attachment

Wire Insulation Support	Without
Contact Retention Type Within Housing	Locking Lance

### Contact Features

Contact Underplating Material	Nickel
Contact Orientation	Straight



Mating Pin Diameter	2.13 mm[.084 in]
Contact Underplating Material Thickness	1.27 μm[50 μin]
Contact Mating Area Plating Material Thickness	.76 μm[30 μin]
Wire Contact Termination Area Plating Material Finish	Bright
Contact Shape & Form	Round
Wire Contact Termination Area Plating Thickness	.76 μm[30 μin]
Barrel Type	Open
Contact Type	Pin
Contact Mating Area Plating Material	Gold
Wire Contact Termination Area Plating Material	Gold
Contact Retention Within Housing	With
Contact Base Material	Brass
Contact Current Rating (Max)	15 A

### Electrical Characteristics

Operating Voltage	250 VAC
-------------------	---------

### Termination Features

Termination Method to Wire & Cable	Crimp
Product Terminates To	Wire & Cable

### Usage Conditions

Operating Temperature Range	-55 – 105 °C[-67 – 221 °F]
-----------------------------	----------------------------

### Operation/Application

Circuit Application	Power
---------------------	-------

### Product Compliance

[For compliance documentation, visit the product page on TE.com>](#)

EU RoHS Directive 2011/65/EU	Compliant
EU ELV Directive 2000/53/EC	Compliant
China RoHS 2 Directive MIIT Order No 32, 2016	No Restricted Materials Above Threshold
EU REACH Regulation (EC) No. 1907/2006	Current ECHA Candidate List: JUNE 2024 (241) Candidate List Declared Against: JUNE 2024 (241) Does not contain REACH SVHC
Halogen Content	Low Halogen - Br, Cl, F, I < 900 ppm per

homogenous material. Also BFR/CFR/PVC Free

Solder Process Capability

Not applicable for solder process capability

Product Compliance Disclaimer

This information is provided based on reasonable inquiry of our suppliers and represents our current actual knowledge based on the information they provided. This information is subject to change. The part numbers that TE has identified as EU RoHS compliant have a maximum concentration of 0.1% by weight in homogenous materials for lead, hexavalent chromium, mercury, PBB, PBDE, DBP, BBP, DEHP, DIBP, and 0.01% for cadmium, or qualify for an exemption to these limits as defined in the Annexes of Directive 2011/65/EU (RoHS2). Finished electrical and electronic equipment products will be CE marked as required by Directive 2011/65/EU. Components may not be CE marked. Additionally, the part numbers that TE has identified as EU ELV compliant have a maximum concentration of 0.1% by weight in homogenous materials for lead, hexavalent chromium, and mercury, and 0.01% for cadmium, or qualify for an exemption to these limits as defined in the Annexes of Directive 2000/53/EC (ELV). Regarding the REACH Regulation, the information TE provides on SVHC in articles for this part number is based on the latest European Chemicals Agency (ECHA) 'Guidance on requirements for substances in articles' posted at this URL: <https://echa.europa.eu/guidance-documents/guidance-on-reach>

## Compatible Parts



TE Part # 91512-1  
CCII CMNL PIN SKT 24-18 ASSY



TE Part # 90574-1  
ASSY PRO-CRIMPER COMM M-N-LOCK



TE Part # 455830-1  
INSERTION TOOL



TE Part # 1-171196-0  
6 POS MATE-N-LOK S



TE Part # 1-480274-0  
09P CMNL PLUG HSG P/M NATL



TE Part # 1-480284-0  
08P CMNL CAP HSG M/M NATL



TE Part # 1-480438-0  
16P CMNL PLUG HSG M/M NATL



TE Part # 1-480683-0  
02P CMNL PLUG HSG F/H NATL



TE Part # 1-480277-0  
09P CMNL CAP HSG P/M NATL



TE Part # 1-480304-0  
03P CMNL PLUG HSG P/M NATL



TE Part # 1-480722-0  
04P CMNL PLUG HSG W/LCK NATL



TE Part # 1-480276-0  
06P CMNL CAP HSG P/M NATL



Also in the Series | **Commercial MATE-N-LOK**

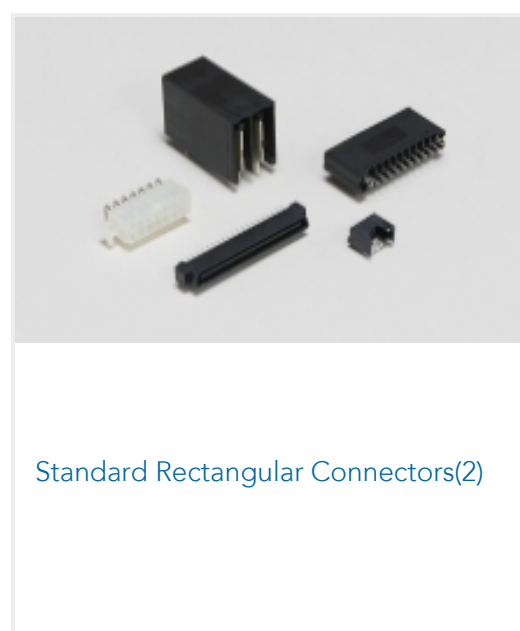
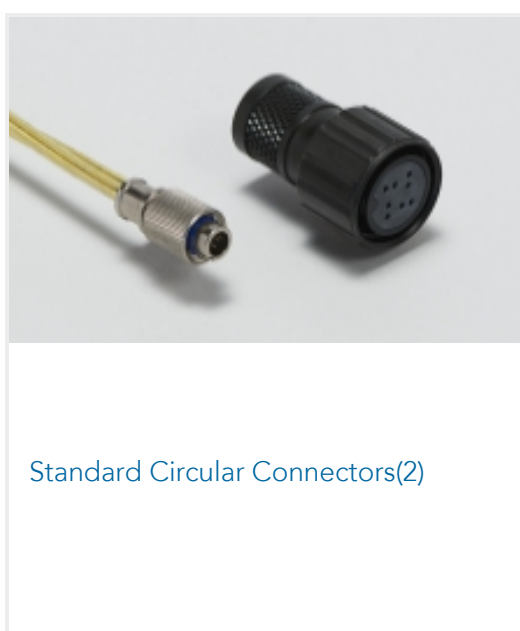
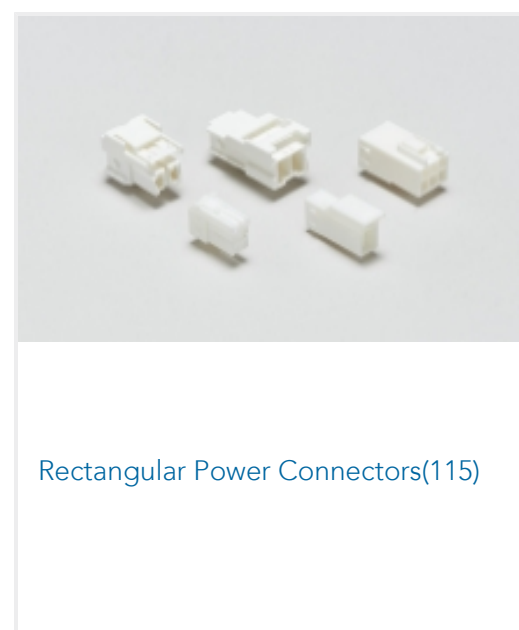
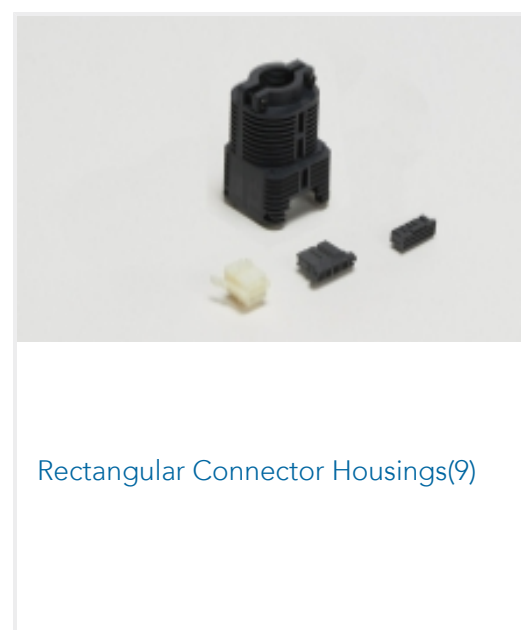
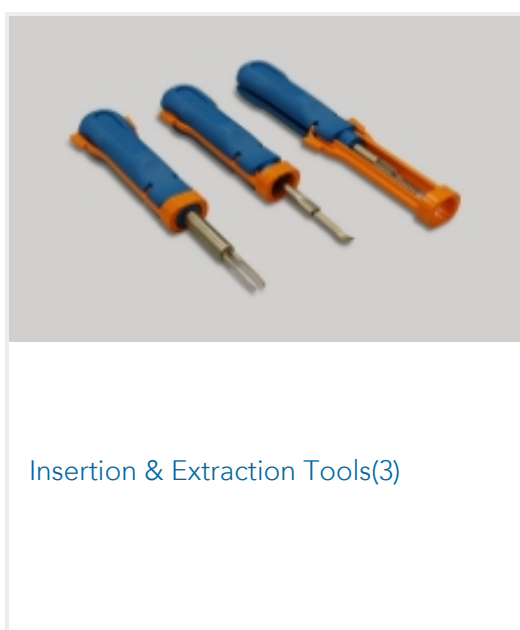
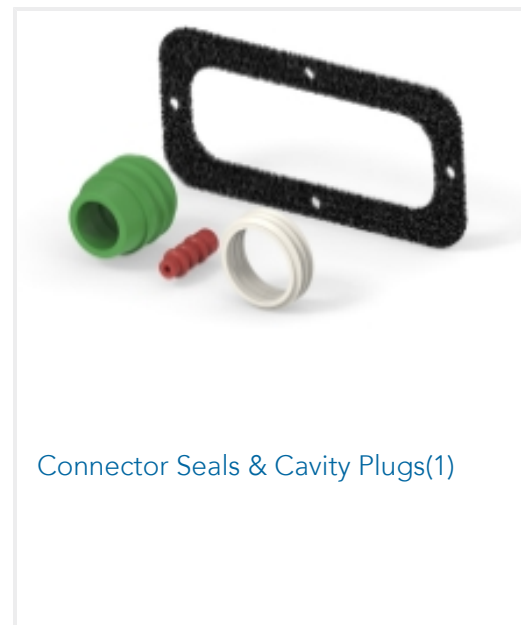
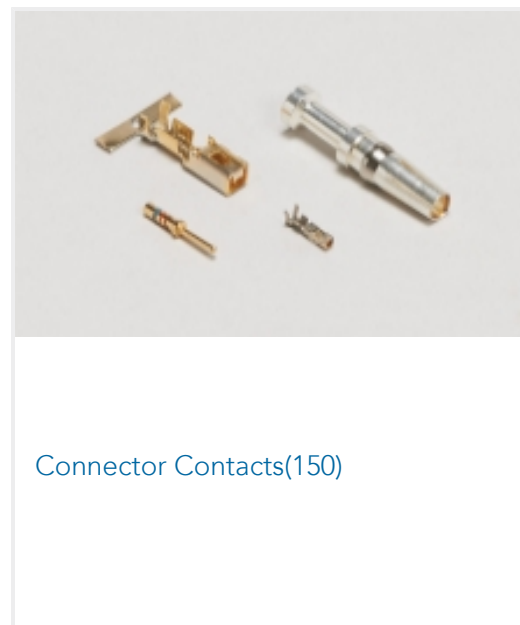

Customers Also Bought



TE Part #M3041-000006-01KPG  
PRESS XDCR M3041-000006-01KPG



TE Part #M3041-000006-250PG  
PRESS XDCR M3041-000006-250PG



TE Part #1-480319-0  
02P CMNL CAP HSG NATL



TE Part #61174-5  
CMNL PIN L/P AUNIBR



TE Part #320749  
SOLIS SPDFLG 22-16COM22-18MIL6



TE Part #330620  
INSUL BUSHING BNC BLKHD PHEN

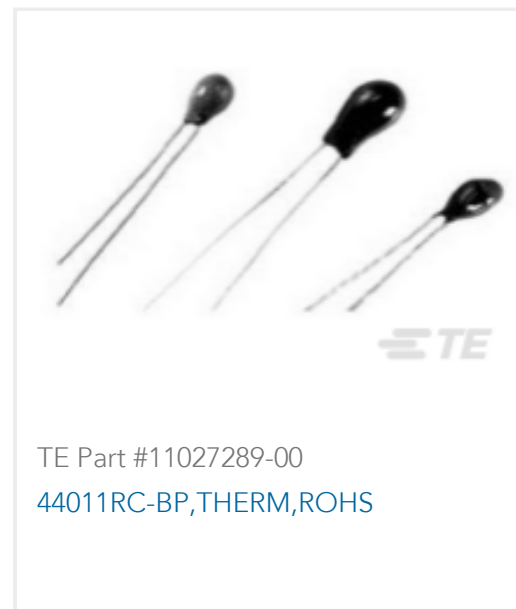

TE Part #11027289-00  
44011RC-BP,THERM,ROHS

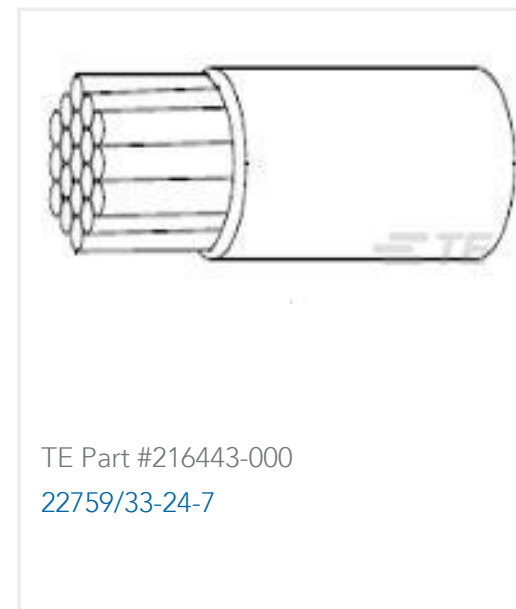

TE Part #216443-000  
22759/33-24-7

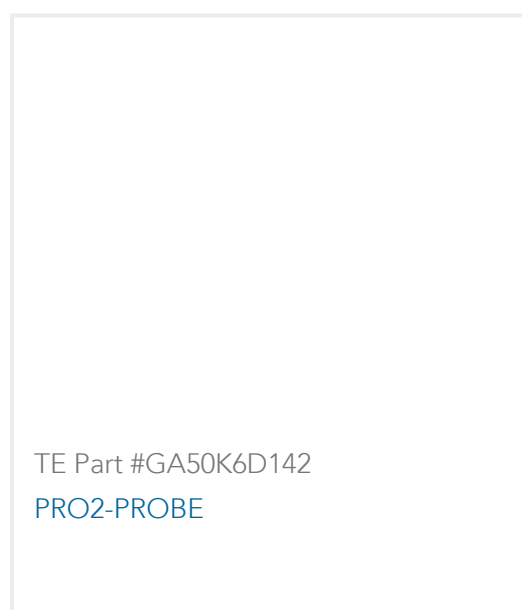

TE Part #GA50K6D142  
PRO2-PROBE

## Documents

### Product Drawings

[CMNL PIN AUBR L/P](#)

English

### CAD Files

[3D PDF](#)

English

**Customer View Model**

[ENG\\_CVM\\_60618-5\\_S.2d\\_dxf.zip](#)

English

**Customer View Model**

[ENG\\_CVM\\_60618-5\\_S.3d\\_igs.zip](#)

English

**Customer View Model**

[ENG\\_CVM\\_60618-5\\_S.3d\\_stp.zip](#)

English

[3D PDF](#)

3D



**Customer View Model**

[ENG\\_CVM\\_CVM\\_60618-5\\_W.2d\\_dxf.zip](#)

English

**Customer View Model**

[ENG\\_CVM\\_CVM\\_60618-5\\_W.3d\\_igs.zip](#)

English

**Customer View Model**

[ENG\\_CVM\\_CVM\\_60618-5\\_W.3d\\_stp.zip](#)

English

By downloading the CAD file I accept and agree to the [Terms and Conditions](#) of use.

---

**Datasheets & Catalog Pages**

[SOFT\\_SHELL\\_PIN\\_SOCKET\\_CONNECTORS\\_STANDARD\\_DENSITY](#)

English

---

**Product Specifications**

[Application Specification](#)

English

---

**Instruction Sheets**

[Instruction Sheet \(U.S.\)](#)

English