

53424-1 ✓ ACTIVE



PIDG

TE Internal #: 53424-1

Closed Ring Tongue Terminal, 12 – 10 AWG, #8 / M4 Stud Size,
4.34 mm [.171 in] Stud Diameter, Closed Barrel, Straight, Tin-Lead,
PIDG

[View on TE.com >](#)

Terminals & Splices > Ring Terminals > PIDG Radiation Resistant C Rings/Spades

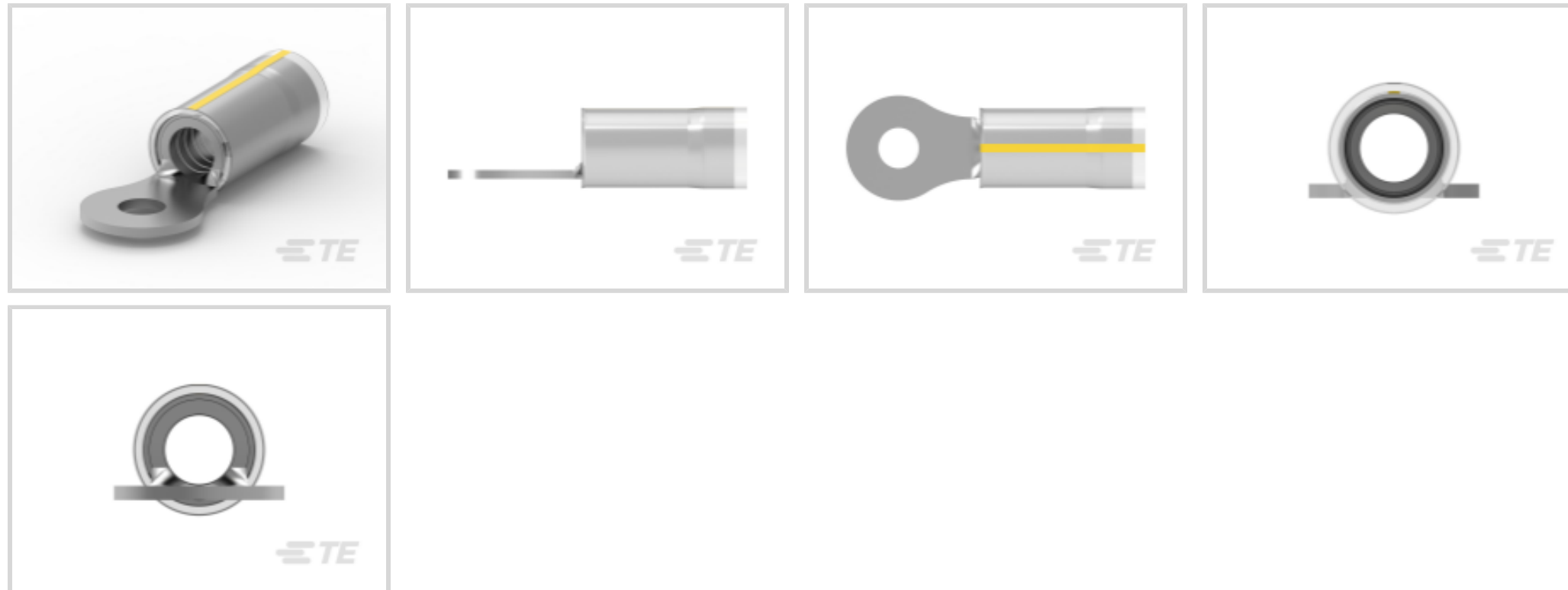

Ring Terminal Product Type: **Closed Ring Tongue Terminal**

Wire Size: **5180 – 13100 CMA**

Stud Size: **#8, M4**

[All PIDG Radiation Resistant C Rings/Spades \(36\)](#)

Features

Product Type Features

Ring Terminal Product Type	Closed Ring Tongue Terminal
Stud Size	#8, M4
Sealable	No
Wire Insulation Support Retention Type	Insulation Support

Dimensions

Wire Size	5180 – 13100 CMA
Stud Diameter	4.34 mm [.171 in]
Tongue Thickness	1.07 mm [.042 in]
Product Length	27.5 mm [1.083 in]
Compatible Insulation Diameter (Max)	5.84 mm [.23 in]
Compatible Insulation Diameter Range	3.81 – 5.84 mm [.15 – .23 in]

Contact Features

Barrel Type	Closed
Terminal Orientation	Straight



Terminal Plating Material	Tin-Lead
---------------------------	----------

Military Part Class	Class I
---------------------	---------

Usage Conditions

Insulation Option	Partially Insulated
-------------------	---------------------

Operating Temperature Range	150 °C[302 °F]
-----------------------------	----------------

Operation/Application

Compatible With Wire Base Material	Copper
------------------------------------	--------

Compatible With Wire Plating Material	Tin
---------------------------------------	-----

Packaging Features

Packaging Method	Loose Piece
------------------	-------------

Packaging Quantity	500
--------------------	-----

Other

EU RoHS Compliance	Not Compliant
--------------------	---------------

EU ELV Compliance	Compliant with Exemptions
-------------------	---------------------------

Configuration Features

Number of Holes	1
-----------------	---

Body Features

Insulation Sleeve Color	Natural
-------------------------	---------

Stripe Color	Yellow
--------------	--------

Mechanical Attachment

Wire Insulation Support	With
-------------------------	------

Industry Standards

Government Qualified Terminal	Yes
-------------------------------	-----

Product Compliance

[For compliance documentation, visit the product page on TE.com>](#)

EU RoHS Directive 2011/65/EU	Not Compliant
------------------------------	---------------

EU ELV Directive 2000/53/EC	Compliant with Exemptions
-----------------------------	---------------------------

China RoHS 2 Directive MIIT Order No 32, 2016	Restricted Materials Above Threshold
---	--------------------------------------

EU REACH Regulation (EC) No. 1907/2006	Current ECHA Candidate List: JUNE 2024 (241) Candidate List Declared Against: JUNE 2024 (241)
--	--



SVHC > Threshold:

Pb (13% in Component Part)

Article Safe Usage Statements:

Do not eat, drink or smoke when using this product. Wash thoroughly after handling. Recycle if possible and dispose of the article by following all applicable governmental regulations relevant to your geographic location.

Halogen Content

Not Low Halogen - contains Br or Cl > 900 ppm.

Solder Process Capability

Not applicable for solder process capability

Product Compliance Disclaimer

This information is provided based on reasonable inquiry of our suppliers and represents our current actual knowledge based on the information they provided. This information is subject to change. The part numbers that TE has identified as EU RoHS compliant have a maximum concentration of 0.1% by weight in homogenous materials for lead, hexavalent chromium, mercury, PBB, PBDE, DBP, BBP, DEHP, DIBP, and 0.01% for cadmium, or qualify for an exemption to these limits as defined in the Annexes of Directive 2011/65/EU (RoHS2). Finished electrical and electronic equipment products will be CE marked as required by Directive 2011/65/EU. Components may not be CE marked. Additionally, the part numbers that TE has identified as EU ELV compliant have a maximum concentration of 0.1% by weight in homogenous materials for lead, hexavalent chromium, and mercury, and 0.01% for cadmium, or qualify for an exemption to these limits as defined in the Annexes of Directive 2000/53/EC (ELV). Regarding the REACH Regulation, the information TE provides on SVHC in articles for this part number is based on the latest European Chemicals Agency (ECHA) 'Guidance on requirements for substances in articles' posted at this URL: <https://echa.europa.eu/guidance-documents/guidance-on-reach>

Compatible Parts

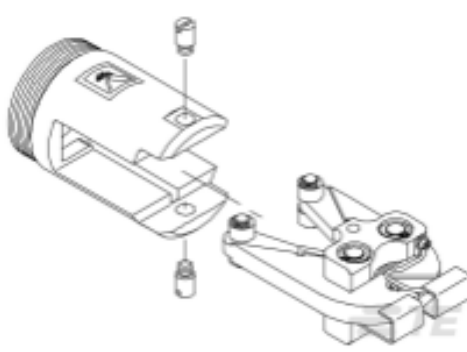

TE Part # 679300-1
1210 PIDG CRIMP HEAD



TE Part # 59824-1
TETRA-CRIMP PIDG PG FASTON 22-10 ASSY



TE Part # 58433-3
PRO CR ASSY, RBY IS9252



TE Part # 59239-4
HHHT PIDG PG 12-10 ASSY



TE Part # 539691-2
ERGO DIE R.B.Y



TE Part # 58423-1
DIE, RBY IS9252



TE Part # 132246-3
TERMINAL RING TONGUE PIDG 22 18



TE Part # 2063030-1
SDE DIESET, RBY, UL



Also in the Series | PIDG

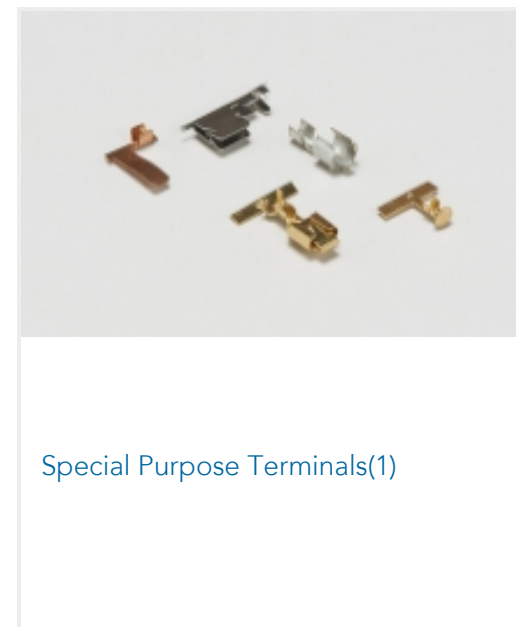
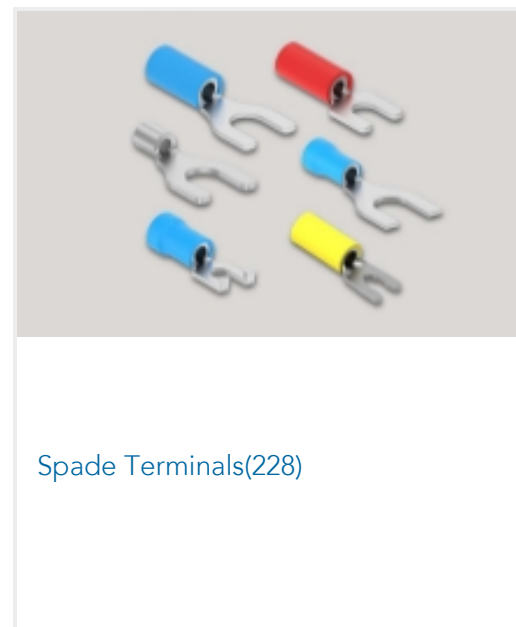
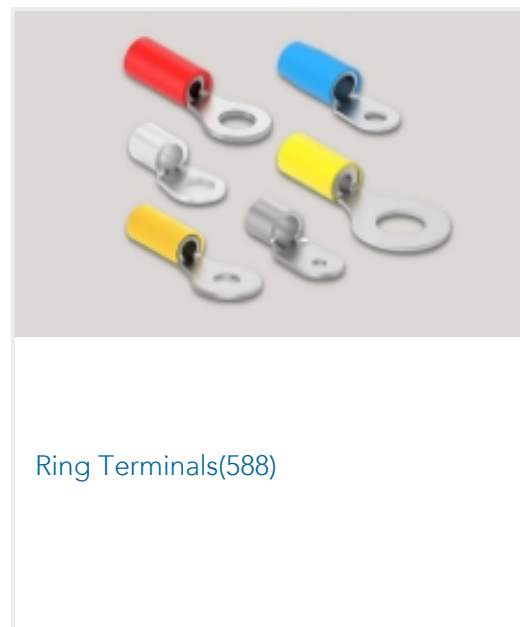
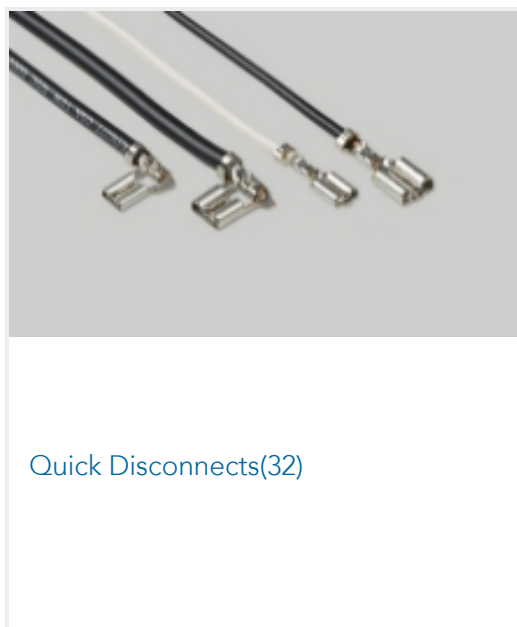
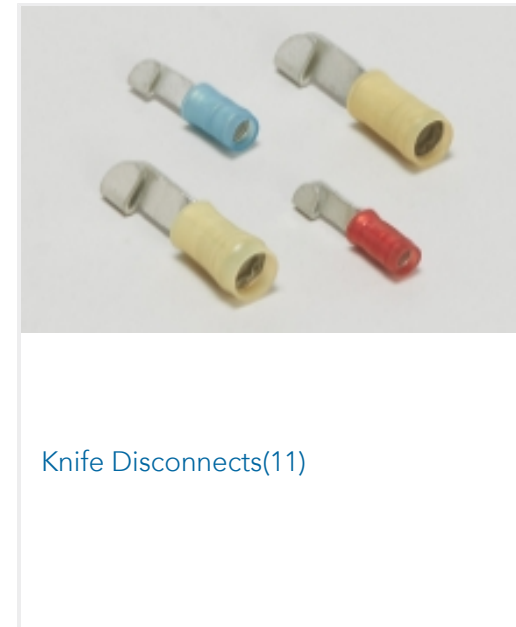
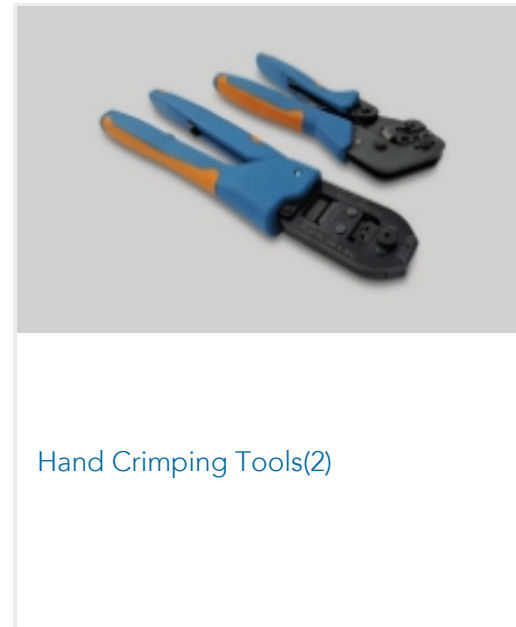
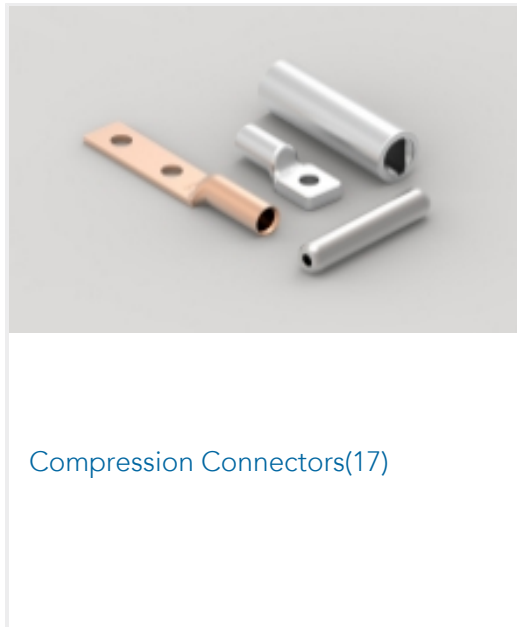

Customers Also Bought

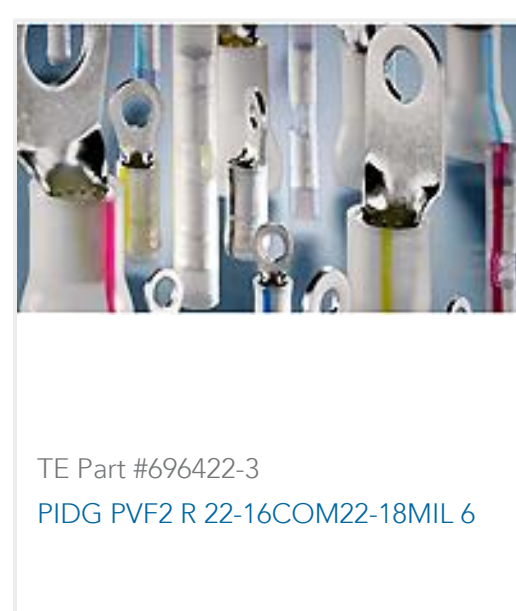



Documents

Product Drawings

[TERMINAL,PIDG PVF2 R 12-10 8](#)

English

CAD Files

3D PDF

3D

Customer View Model

[ENG_CVM_CVM_53424-1_W.2d_dxf.zip](#)

English

Customer View Model

[ENG_CVM_CVM_53424-1_W.3d_igs.zip](#)

English

Customer View Model

[ENG_CVM_CVM_53424-1_W.3d_stp.zip](#)

English

3D PDF

English

Customer View Model

[ENG_CVM_53424-1_S1.3d_igs.zip](#)

English

Customer View Model

[ENG_CVM_53424-1_S1.3d_stp.zip](#)

English

Customer View Model

[ENG_CVM_53424-1_S1.2d_dxf.zip](#)

English

By downloading the CAD file I accept and agree to the [Terms and Conditions](#) of use.