



PLASTI-GRIP

TE Internal #: 34203

Butt Splice, 22 – 16 AWG Wire Size, .3 – 1.42 mm² Wire Size, Serrated, 509 – 3260 CMA Wire Size, Copper, Red, PLASTI-GRIP, Splices

[View on TE.com >](#)

Terminals & Splices > Splices



Splice Type: **Butt Splice**
 Wire Size: **.3 – 1.42 mm²**
 Sealable: **No**
 Splice Features: **Serrated**

Features

Packaging Features

Packaging Quantity	1000
Packaging Method	Loose Piece

Body Features

Product Weight	.321 g
Insulation Material	Vinyl
Splice Features	Serrated
Primary Product Color	Red

Product Type Features

Splice Accessory Type	Splice
Splice Type	Butt Splice
Sealable	No
Compatible With Discrete Wire Type	Solid, Stranded
Wire Insulation Support Retention Type	Insulation Support

Configuration Features

--	--



Compatible With Wire & Cable Type	Discrete Wire
-----------------------------------	---------------

Contact Features

Contact Base Material	Copper
-----------------------	--------

Barrel Type	Closed
-------------	--------

Mechanical Attachment

Wire Insulation Support	With
-------------------------	------

Dimensions

Wire Size	509 – 3260 CMA
-----------	----------------

Compatible Insulation Diameter Range	4.34 mm[.171 in]
--------------------------------------	------------------

Product Length	26.16 mm[1.03 in]
----------------	-------------------

Usage Conditions

Insulation Option	Fully Insulated
-------------------	-----------------

Operating Temperature Range	90 °C[194 °F]
-----------------------------	---------------

Operation/Application

Compatible With Wire Base Material	Copper
------------------------------------	--------

Industry Standards

Government Qualified Splice	No
-----------------------------	----

Other

EU RoHS Compliance	Compliant
--------------------	-----------

EU ELV Compliance	Compliant
-------------------	-----------

Product Compliance

[For compliance documentation, visit the product page on TE.com>](#)

EU RoHS Directive 2011/65/EU	Compliant
------------------------------	-----------

EU ELV Directive 2000/53/EC	Compliant
-----------------------------	-----------

China RoHS 2 Directive MIIT Order No 32, 2016	No Restricted Materials Above Threshold
---	---

EU REACH Regulation (EC) No. 1907/2006	Current ECHA Candidate List: JUNE 2024 (241) Candidate List Declared Against: JUNE 2024 (241) Does not contain REACH SVHC
--	---

Halogen Content	Not Low Halogen - contains Br or Cl > 900 ppm.
-----------------	--

Solder Process Capability	Not applicable for solder process capability
---------------------------	--



Product Compliance Disclaimer

This information is provided based on reasonable inquiry of our suppliers and represents our current actual knowledge based on the information they provided. This information is subject to change. The part numbers that TE has identified as EU RoHS compliant have a maximum concentration of 0.1% by weight in homogenous materials for lead, hexavalent chromium, mercury, PBB, PBDE, DBP, BBP, DEHP, DIBP, and 0.01% for cadmium, or qualify for an exemption to these limits as defined in the Annexes of Directive 2011/65/EU (RoHS2). Finished electrical and electronic equipment products will be CE marked as required by Directive 2011/65/EU. Components may not be CE marked. Additionally, the part numbers that TE has identified as EU ELV compliant have a maximum concentration of 0.1% by weight in homogenous materials for lead, hexavalent chromium, and mercury, and 0.01% for cadmium, or qualify for an exemption to these limits as defined in the Annexes of Directive 2000/53/EC (ELV). Regarding the REACH Regulation, the information TE provides on SVHC in articles for this part number is based on the latest European Chemicals Agency (ECHA) 'Guidance on requirements for substances in articles' posted at this URL: <https://echa.europa.eu/guidance-documents/guidance-on-reach>

Compatible Parts



REPRESENTATION ONLY

TE Part # 47386
DAHT PG PIDG 26-16 ASSY



TE Part # 58433-3
PRO CR ASSY, RBY IS9252



TE Part # 58423-1
DIE, RBY IS9252



REPRESENTATION ONLY

TE Part # 45160
DAHT PG 22-16 ASSY



TE Part # 169404
CERTI-LOK DIE

Also in the Series | PLASTI-GRIP

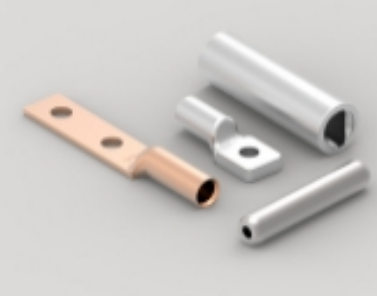

Compression Connectors(3)



Crimp Wire Pins, Tabs & Ferrules(18)



Ring Terminals(297)

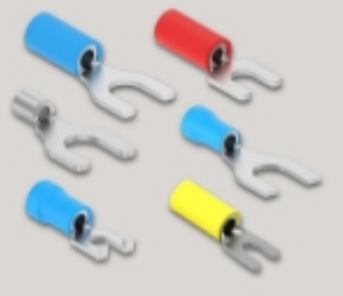

Spade Terminals(157)



Splices(44)

Customers Also Bought

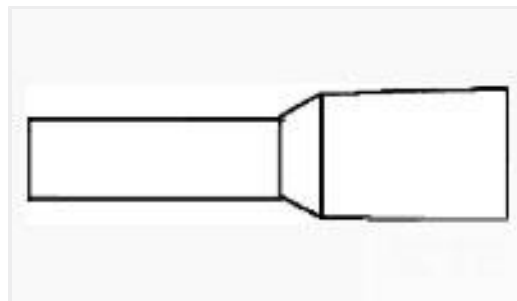
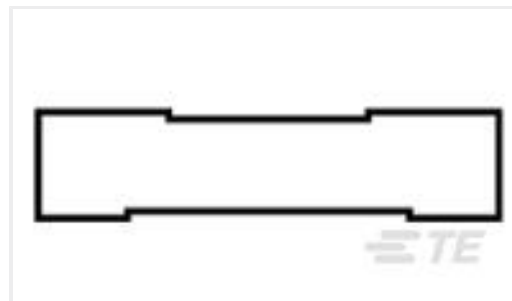
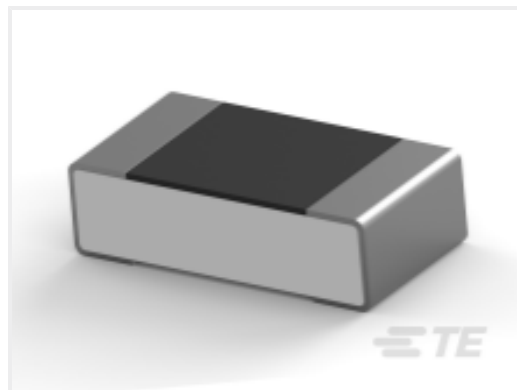
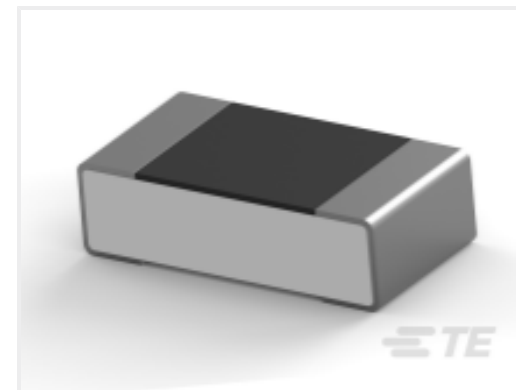
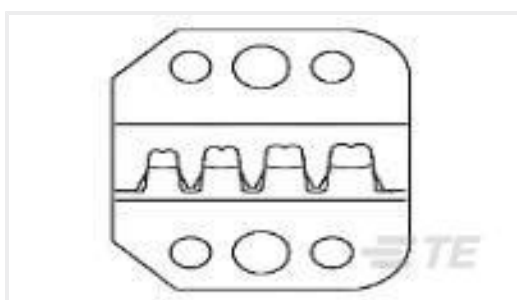
TE Part #5-532955-7
40 MODII 2PC CE RCPT ASSY, RoHSTE Part #966144-6
FER,WIRE,DBL,PL SLV,1.50/16,L8,
BLACK,LPTE Part #55792-1
PG BUTT SPLC 22-16COMM22-18MILTE Part #34071
SPLICE,PG BUTT 16-14TE Part #L9000033-01
Antenna 1/4 Wave Short 2.4GHz RPSTE Part #3-2176370-6
RQ 0603 1K0 0.1% 10PPM 5K RLTE Part #7-2176369-7
RQ 0603 249R 0.1% 10PPM 5K RLTE Part #9-2176370-1
RQ 0603 3K74 0.1% 10PPM 5K RLTE Part #58641-2
PROCRIMP DIE MOD IV

Documents

Product Drawings

[PG BUTT SPLC 22-16COMM22-18MIL](#)

English

CAD Files

Customer View Model

[ENG_CVM_34203_F.3d_igs.zip](#)

English

Customer View Model



[ENG_CVM_34203_F.3d_stp.zip](#)

English

Customer View Model

[ENG_CVM_34203_F.2d_dxf.zip](#)

English

3D PDF

English

By downloading the CAD file I accept and agree to the [Terms and Conditions](#) of use.

Product Specifications

[Application Specification](#)

English

Instruction Sheets

[Instruction Sheet \(U.S.\)](#)

English

Agency Approvals

[UL Report](#)

English

[UL Report](#)

English