

53242-1 ✓ ACTIVE

PLASTI-GRIP

TE Internal #: 53242-1

Spring Spade Terminal, 22 – 16 AWG, #10 Stud Size, 4.83 mm [.19 in] Stud Diameter, Closed Barrel, Straight, Tin, Partially Insulated, PLASTI-GRIP

[View on TE.com >](#)



Terminals & Splices > Spade Terminals

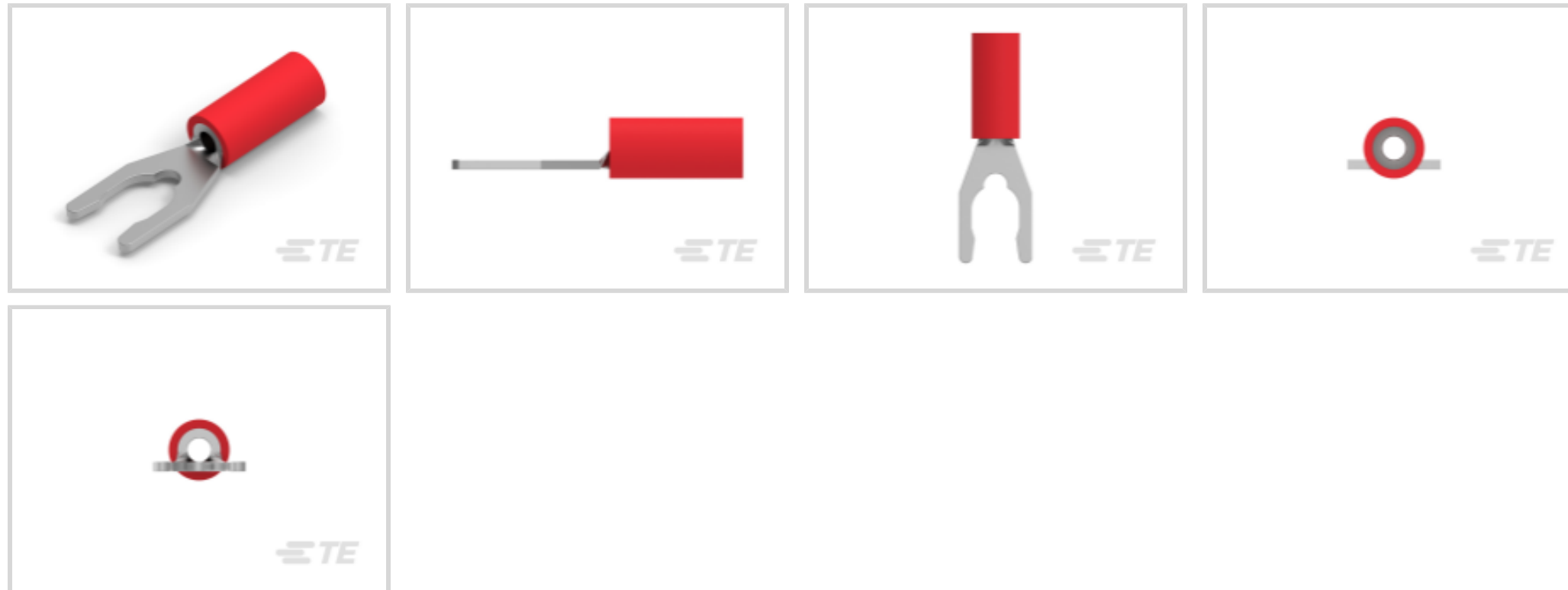

Spade Terminal Type: **Spring Spade Terminal**

Wire Size: **509 – 3260 CMA**

Stud Size: **#10**

Features

Contact Features

Spade Terminal Type	Spring Spade Terminal
Barrel Type	Closed
Terminal Orientation	Straight
Terminal Plating Material	Tin

Dimensions

Wire Size	509 – 3260 CMA
Stud Diameter	4.83 mm [.19 in]
Tongue Thickness	.79 mm [.031 in]
Product Length	23.37 mm [.92 in]
Compatible Insulation Diameter (Max)	3.56 mm [.14 in]
Compatible Insulation Diameter Range	2.67 – 3.56 mm [.105 – .14 in]

Product Type Features

Stud Size	#10
Sealable	No
Wire Insulation Support Retention Type	Insulation Support



Usage Conditions

Insulation Option	Partially Insulated
Operating Temperature Range	105 °C[221 °F]

Operation/Application

Compatible With Wire Base Material	Copper
Compatible With Wire Plating Material	Tin

Packaging Features

Packaging Method	Loose Piece
Packaging Quantity	1000

Other

EU RoHS Compliance	Compliant
EU ELV Compliance	Compliant

Electrical Characteristics

Voltage Rating	1000 V, 600 V
----------------	---------------

Body Features

Product Weight	.155 g
Insulation Sleeve Color	Red
Stripe Color	Red

Mechanical Attachment

Wire Insulation Support	With
-------------------------	------

Industry Standards

Government Qualified Terminal	No
-------------------------------	----

Product Compliance

[For compliance documentation, visit the product page on TE.com>](#)

EU RoHS Directive 2011/65/EU	Compliant
EU ELV Directive 2000/53/EC	Compliant
China RoHS 2 Directive MIIT Order No 32, 2016	No Restricted Materials Above Threshold
EU REACH Regulation (EC) No. 1907/2006	Current ECHA Candidate List: JUNE 2024 (241) Candidate List Declared Against: JUNE 2024 (241) Does not contain REACH SVHC

Halogen Content

Not Low Halogen - contains Br or Cl > 900 ppm.

Solder Process Capability

Not applicable for solder process capability

Product Compliance Disclaimer

This information is provided based on reasonable inquiry of our suppliers and represents our current actual knowledge based on the information they provided. This information is subject to change. The part numbers that TE has identified as EU RoHS compliant have a maximum concentration of 0.1% by weight in homogenous materials for lead, hexavalent chromium, mercury, PBB, PBDE, DBP, BBP, DEHP, DIBP, and 0.01% for cadmium, or qualify for an exemption to these limits as defined in the Annexes of Directive 2011/65/EU (RoHS2). Finished electrical and electronic equipment products will be CE marked as required by Directive 2011/65/EU. Components may not be CE marked. Additionally, the part numbers that TE has identified as EU ELV compliant have a maximum concentration of 0.1% by weight in homogenous materials for lead, hexavalent chromium, and mercury, and 0.01% for cadmium, or qualify for an exemption to these limits as defined in the Annexes of Directive 2000/53/EC (ELV). Regarding the REACH Regulation, the information TE provides on SVHC in articles for this part number is based on the latest European Chemicals Agency (ECHA) 'Guidance on requirements for substances in articles' posted at this URL: <https://echa.europa.eu/guidance-documents/guidance-on-reach>

Compatible Parts



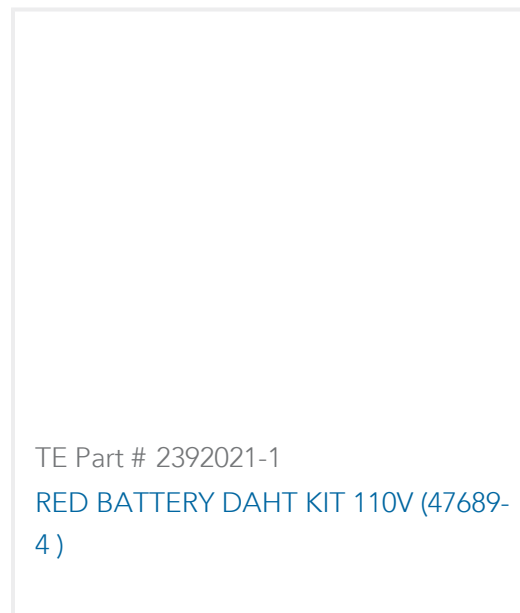
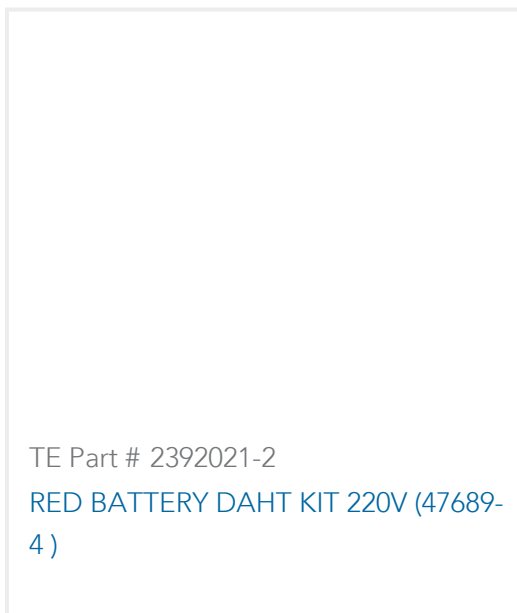

Also in the Series | **PLASTI-GRIP**

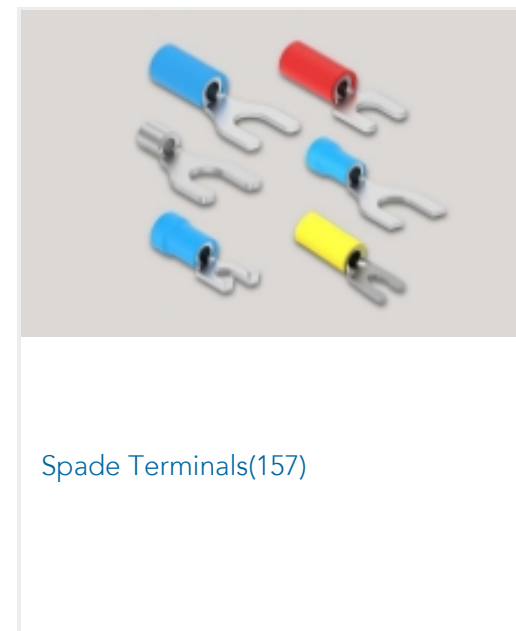
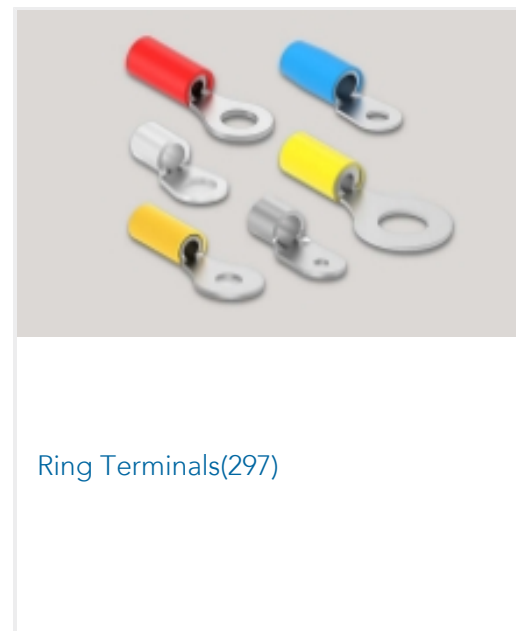
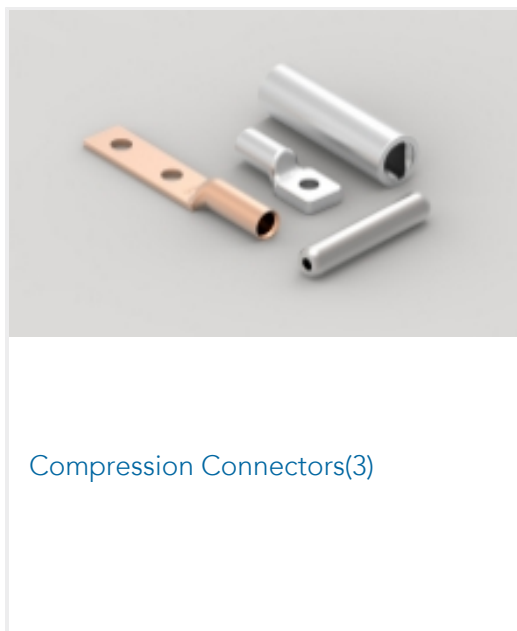

Customers Also Bought

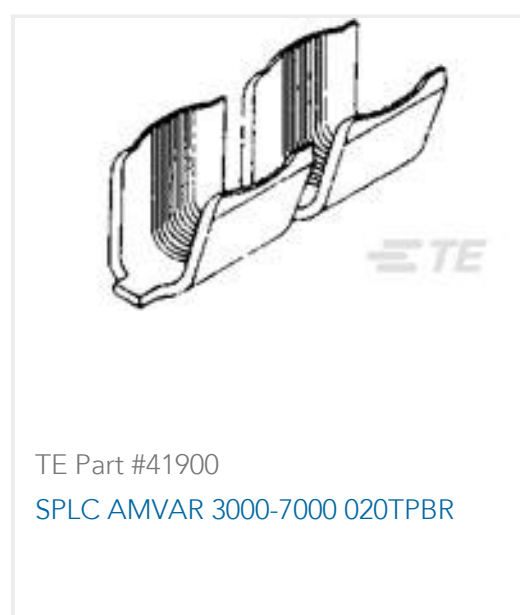



Documents

Product Drawings

[PG SPR SPD 22-16COM22-18MIL 10](#)

English

CAD Files

3D PDF

3D

Customer View Model

[ENG_CVM_CVM_53242-1_J.2d_dxf.zip](#)

English

Customer View Model

[ENG_CVM_CVM_53242-1_J.3d_igs.zip](#)

English

Customer View Model

[ENG_CVM_CVM_53242-1_J.3d_stp.zip](#)

English

Customer View Model

[ENG_CVM_53242-1_K.3d_igs.zip](#)

English

Customer View Model

[ENG_CVM_53242-1_K.3d_stp.zip](#)

English

Customer View Model

[ENG_CVM_53242-1_K.2d_dxf.zip](#)

English

3D PDF

English

By downloading the CAD file I accept and agree to the [Terms and Conditions](#) of use.

Product Specifications

[Application Specification](#)

English

Agency Approvals

[UL Report](#)

English

53242-1

Spring Spade Terminal, 22 – 16 AWG, #10 Stud Size, 4.83 mm [.19 in] Stud Diameter,
Closed Barrel, Straight, Tin, Partially Insulated, PLASTI-GRIP



UL Report

English