

This document is the property of Amphenol Corporation and is delivered on the express condition that is not to be disclosed, reproduced or used, in whole or in part, for manufacture or sale by anyone other than Amphenol Corporation without its prior consent, and that no right is granted to disclose or to use any information in this document.  
The marking on this product doesn't contain environmental hazardous materials per directive 2011/65/EU & 2015/863/EU for RoHS compliant.



ORIGINAL



REVISIONS				
SYM	ECN No.	DESCRIPTION	DATE	APPROVED
A	NE-17059	RELEASE TO PRODUCTION	04/06/2017	Roger Tsai
B	NE-18205	UPDATED 2X9POS CAP, UPDATED PKG QTY. ADDED 2X3 POS OPTION, ADDED SHEET2 FOR RIB OPTION	10/17/2018	Roger Tsai
C	NE-19186	ADD A GROOVE FOR SEMI-AUTOMATIC PROCESSING	11/22/2019	Roger Tsai
D	NE-21029	ADD NOTE FOR CAP COLOR BLACK OR WHITE	03/05/2021	Juda Liu

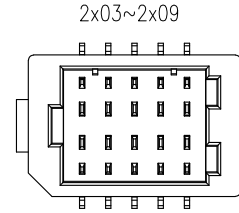
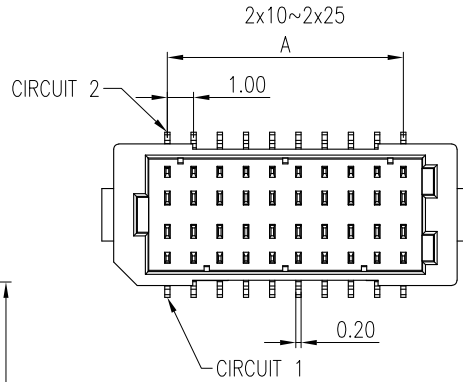
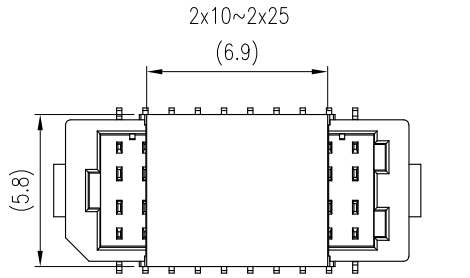

NOTES:

- MATERIAL:
  - HOUSING: HIGH TEMPERATURE THERMAL PLASTIC NYLON9T, UL94V-0, COLOR: OPTION
  - CAP: HIGH TEMPERATURE THERMAL PLASTIC NYLON9T, UL94V-0, COLOR: PIN 2\*03~2\*09, BLACK. COLOR: PIN 2\*10~2\*25, SAME AS HOUSING.
  - TERMINAL: COPPER ALLOY.
  - FITTING NAIL: COPPER ALLOY.
- FINISH:
  - TERMINAL: SELECTIVE PLATING THICKNESS MIN. OVERALL;
  - UNDER PLATING: NICKEL PLATING 50 μ" THICKNESS MIN. OVERALL.
  - FITTING NAIL: MATTE TIN PLATING 100 μ" THICKNESS MIN. OVERALL; UNDER PLATING: NICKEL PLATING 50 μ" THICKNESS MIN. OVERALL.
- PRODUCT SPECIFICATION REFER TO : PS-7506.
- TEST SUMMARY REFER TO : TS-7506-XXX.
- THIS PRODUCT DOESN'T CONTAIN ENVIRONMENTAL HAZARDOUS PER DIRECTIVE 2011/65/EU & 2015/863/EU FOR RoHS COMPLIANT.
- TO ENSURE CURRENT RATING CAPABILITY, AMPHENOL PART NUMBERS IN THE CHART ARE RECOMMENDED.(G842AHXXT4EU CABLE HOUSING SERIES WITH G842ACX2XTEU TERMINAL SERIES.)

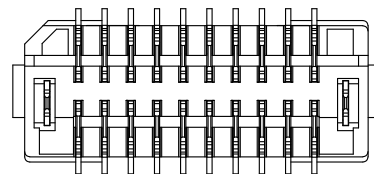
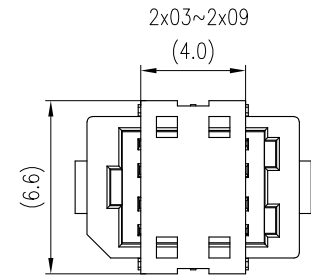
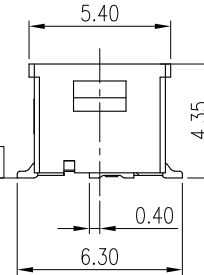
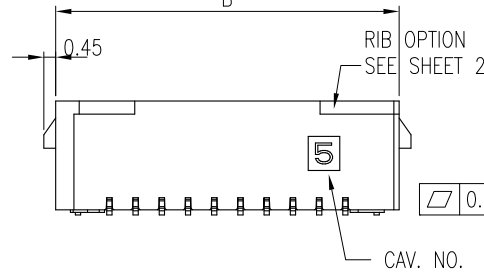
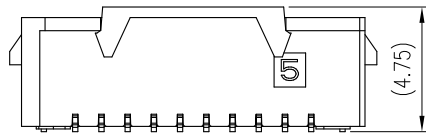

PART NO. G846AXX2XXXT4EU  
NO. OF CIRCUIT  
CONTACT FINISH  
0: 100μ" TIN  
1: GOLD FLASH  
2: 15μ" GOLD  
3: 30μ" GOLD  
COLOR OPTION  
BLANK: WHITE  
1: BLACK  
CAP OPTION  
1: WITH CAP

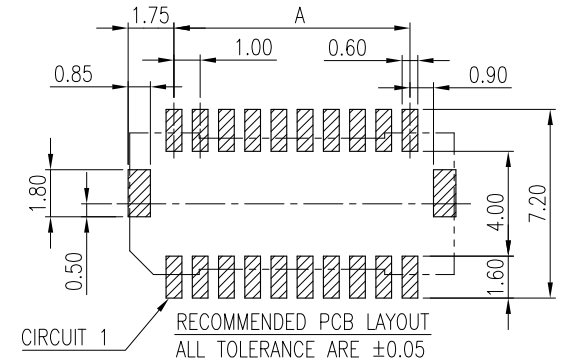

PIN	DIM.(mm)		PIN	DIM.(mm)	
	A	B		A	B
2x03	2.00	6.10	2x10	9.00	13.10
2x04	3.00	7.10	2x11	10.00	14.10
2x05	4.00	8.10	2x12	11.00	15.10
2x06	5.00	9.10	2x15	14.00	18.10
2x07	6.00	10.10	2x20	19.00	23.10
2x08	7.00	11.10	2x25	24.00	28.10
2x09	8.00	12.10			

TOLERANCE			APPROVALS			DATE			TITLE				
X.			DRAWN	Juda Liu	03/05/2021	G846A SERIES, WTB CONN.			Amphenol® Amphenol Corporation Amphenol Taiwan Corporation				
X.X	±0.30		CHECKED	Aqua Chou	03/05/2021	1.00 PITCH, VERTICAL SMT TYPE							
X.XX	±0.20		APPROVED	Roger Tsai	03/05/2021	UNIT	mm	SIZE	A3	PART No.	G846AXX2XXXT4EU		
X.XXX	±0.10		DWG TYPE	CUST DWG	PROJECT CODE	BHD	SCALE	NA	SHEET	1 OF 4	DWG No.	G846AXX2XXXT4EU	
ANGULAR	±1°		UNLESS OTHERWISE SPECIFIED			UNIT			mm	SIZE	A3	REV.	D

This document is the property of Amphenol Corporation and is delivered on the express condition that is not to be disclosed, reproduced or used, in whole or in part, for manufacture or sale by anyone other than Amphenol Corporation without its prior consent, and that no right is granted to disclose or to use any information in this document.  
The marking on this product doesn't contain environmental hazardous materials per directive 2011/65/EU & 2015/863/EU for RoHS compliant.

ORIGINAL

REVISIONS				
SYM	ECN No.	DESCRIPTION	DATE	APPROVED
A	NE-17059	RELEASE TO PRODUCTION	04/06/2017	Roger Tsai
B	NE-18205	UPDATED 2X9POS CAP, UPDATED PKG QTY. ADDED 2X3 POS OPTION, ADDED SHEET2 FOR RIB OPTION	10/17/2018	Roger Tsai
C	NE-19186	ADD A GROOVE FOR SEMI-AUTOMATIC PROCESSING	11/22/2019	Roger Tsai
D	NE-21029	ADD NOTE FOR CAP COLOR BLACK OR WHITE	03/05/2021	Juda Liu

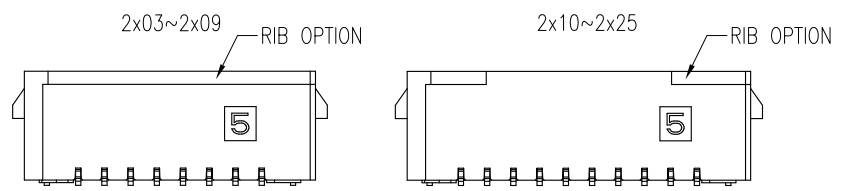

2X05

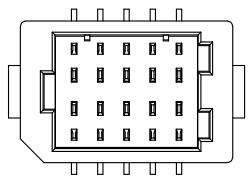

2X08

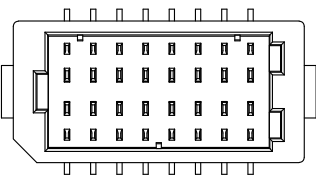

2X11

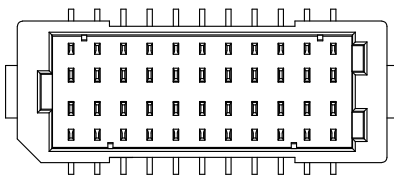

2X20

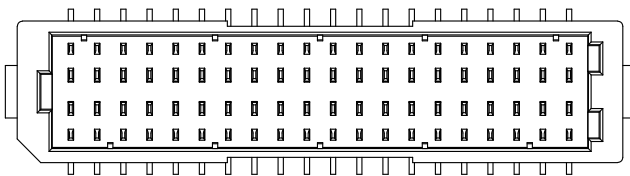

2X06

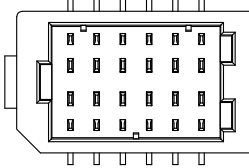

2X09

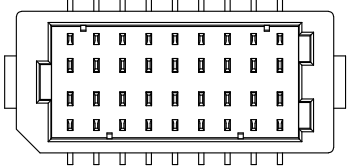

2X12

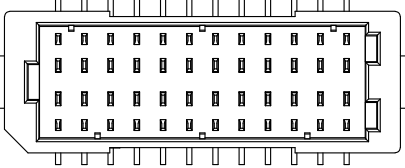

2X25

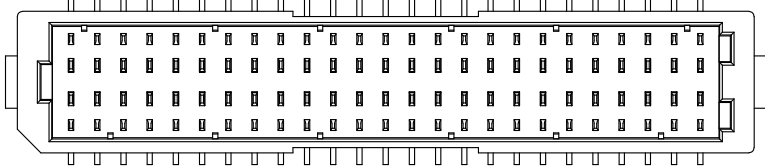

2X07

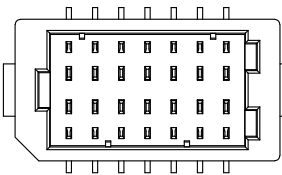

2X10

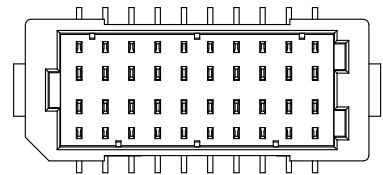

2X15

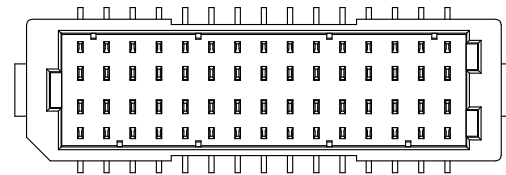

2X03

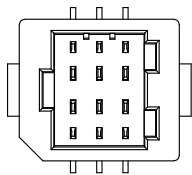

2X04

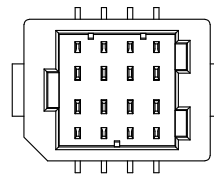

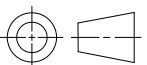
TOLERANCE		APPROVALS		DATE	TITLE G846A SERIES, WTB CONN. 1.00 PITCH, VERTICAL SMT TYPE	 Amphenol Corporation Amphenol Taiwan Corporation			
X.		DRAWN	Juda Liu	03/05/2021					
X.X	±0.30	CHECKED	Aqua Chou	03/05/2021					
X.XX	±0.20	APPROVED	Roger Tsai	03/05/2021					
X.XXX	±0.10	DWG TYPE	CUST DWG	PROJECT CODE BHD		UNIT mm	SIZE A3	PART No. G846AXX2XXX4EU	
ANGULAR ±1°		UNLESS OTHERWISE SPECIFIED			SCALE NA	SHEET 2 OF 4	DWG No. G846AXX2XXX4EU		REV. D

This document is the property of Amphenol Corporation and is delivered on the express condition that is not to be disclosed, reproduced or used, in whole or in part, for manufacture or sale by anyone other than Amphenol Corporation without its prior consent, and that no right is granted to disclose or to use any information in this document.  
The marking on this product doesn't contain environmental hazardous materials per directive 2011/65/EU & 2015/863/EU for RoHS compliant.



ORIGINAL



REVISIONS				
SYM	ECN No.	DESCRIPTION	DATE	APPROVED
A	NE-17059	RELEASE TO PRODUCTION	04/06/2017	Roger Tsai
B	NE-18205	UPDATED 2X9POS CAP, UPDATED PKG QTY. ADDED 2X3 POS OPTION, ADDED SHEET2 FOR RIB OPTION	10/17/2018	Roger Tsai
C	NE-19186	ADD A GROOVE FOR SEMI-AUTOMATIC PROCESSING	11/22/2019	Roger Tsai
D	NE-21029	ADD NOTE FOR CAP COLOR BLACK OR WHITE	03/05/2021	Juda Liu

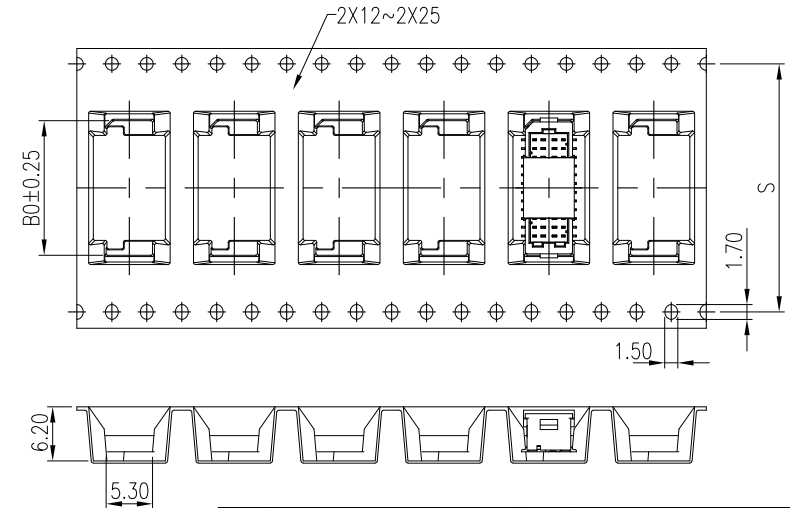
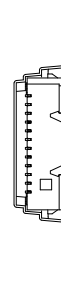
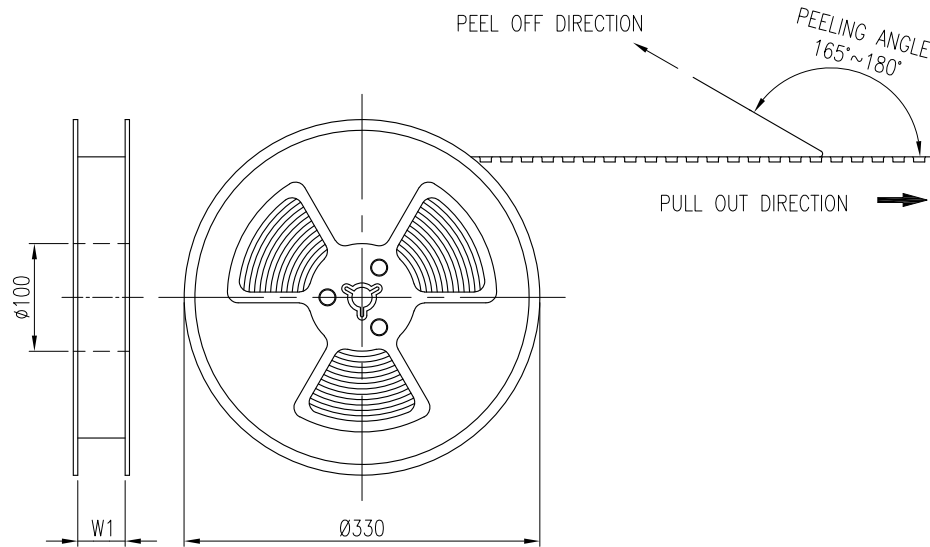
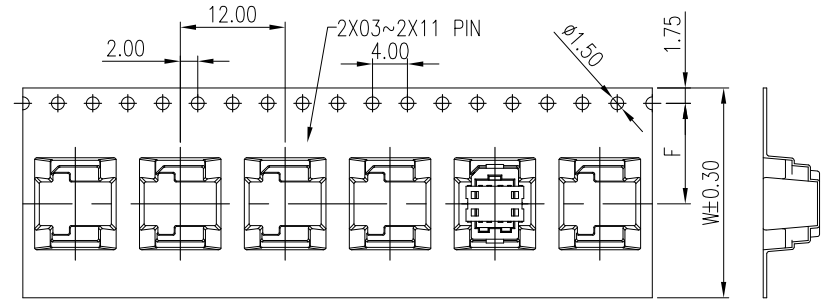
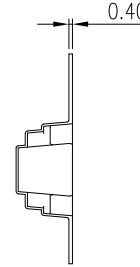
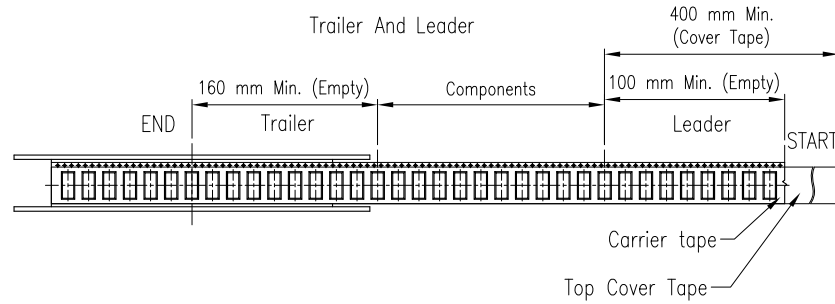

PIN	DIM.(mm)					PIN	DIM.(mm)				
	B0	F	S	W	W1		B0	F	S	W	W1
2x03	6.4	7.5	--	160	16.5	2x10	13.4	11.5	--	24.0	24.5
2x04	7.4					2x11	14.4				
2x05	8.4					2x12	15.4	14.2	28.4	32.0	32.5
2x06	9.4					2x15	18.4				
2x07	10.4	11.5	--	24.0	24.5	2x20	23.4	20.2	40.4	44.0	44.5
2x08	11.4					2x25	28.4				
2x09	12.4										

- 10 SPROCKET HOLE PITCH CUMULATIVE TOLERANCE  $\pm 0.20$
- CARRIER CAMBER IS WITHIN 1 mm IN 250 mm
- THE TOTAL TEARING CONTROL RANGE OF TOP COVER TAPE IS 10~130g, REFERENCE SPEC: EIA-481-D
- PEELING SPEED: 300mm/MINUTES, REFERENCE SPEC: EIA-481-D
- MATERIAL: TRANSPARENT CONDUCTIVE POLYSTYRENE ALLOY.(UP-5000)
- ALL DIMENSIONS MEET EIA-481-D REQUIREMENTS
- THICKNESS :  $0.40 \pm 0.05$ mm
- COMPONENT LOAD PER 13" REEL : 800 PCS

TOLERANCE	APPROVALS	DATE	TITLE	UNIT	SIZE	PART No.
X. X.X X.XX X.XXX	DRAWN Juda Liu	03/05/2021	G846A SERIES, WTB CONN. 1.00 PITCH, VERTICAL SMT TYPE	mm	A3	G846AXX2XXX4EU
	CHECKED Aqua Chou	03/05/2021				
ANGULAR	APPROVED Roger Tsai	03/05/2021				
UNLESS OTHERWISE SPECIFIED	DWG TYPE CUST DWG	PROJECT CODE BHD		SCALE NA	SHEET 3 OF 4	DWG No. G846AXX2XXX4EU

**Amphenol**<sup>®</sup>  
Amphenol Corporation  
Amphenol Taiwan Corporation

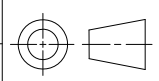

REV. D

This document is the property of Amphenol Corporation and is delivered on the express condition that is not to be disclosed, reproduced or used, in whole or in part, for manufacture or sale by anyone other than Amphenol Corporation without its prior consent, and that no right is granted to disclose or to use any information in this document.  
The marking on this product doesn't contain environmental hazardous materials per directive 2011/65/EU & 2015/863/EU for RoHS compliant.



ORIGINAL



REVISIONS					
SYM	ECN No.	DESCRIPTION	DATE	APPROVED	
A	NE-17059	RELEASE TO PRODUCTION	04/06/2017	Roger Tsai	
B	NE-18205	UPDATED 2X9POS CAP, UPDATED PKG QTY. ADDED 2X3 POS OPTION, ADDED SHEET2 FOR RIB OPTION	10/17/2018	Roger Tsai	
C	NE-19186	ADD A GROOVE FOR SEMI-AUTOMATIC PROCESSING	11/22/2019	Roger Tsai	
D	NE-21029	ADD NOTE FOR CAP COLOR BLACK OR WHITE	03/05/2021	Juda Liu	

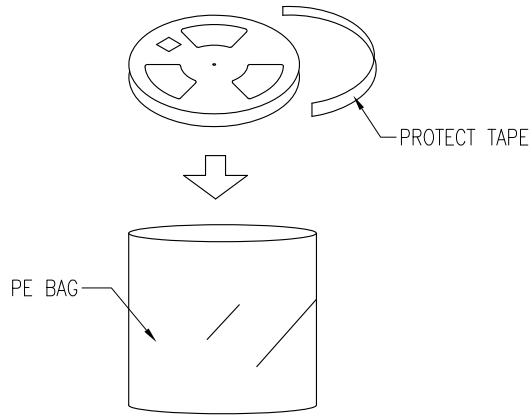

PACKING MATERIAL		PACKING CAPACITY			
PART NAME	DIM.(mm)	PIN	PCS/RE	RE/BC	PCS/BC
REEL	∅330*(W+0.5)	2x03	800	12	9,600
CARTON	350*350*340	2x04~2x11	800	9	7,200
		2x12	800	7	5,600
		2x15~2x25	800	6	4,800

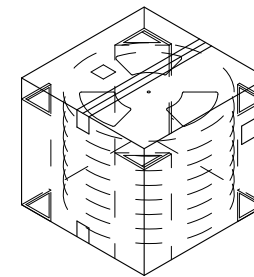
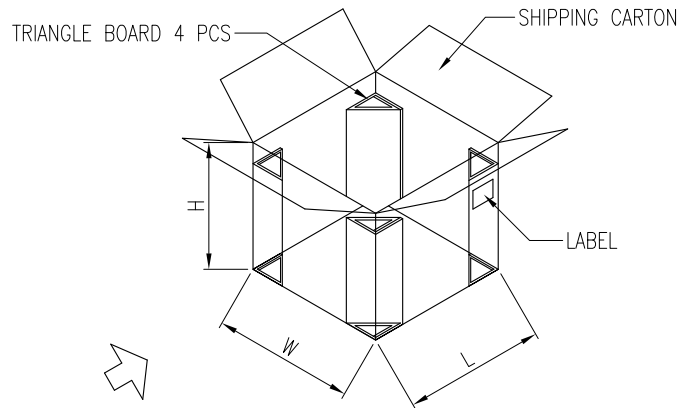
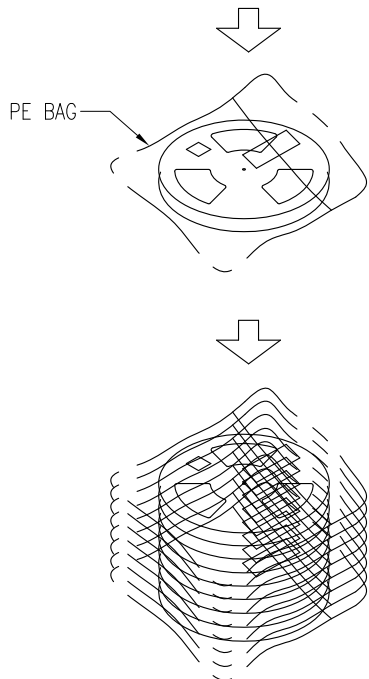

TOLERANCE		APPROVALS		DATE	TITLE		Amphenol®						
X.		DRAWN	Juda Liu	03/05/2021	G846A SERIES, WTB CONN. 1.00 PITCH, VERTICAL SMT TYPE		Amphenol Corporation Amphenol Taiwan Corporation						
X.X	±0.30	CHECKED	Aqua Chou	03/05/2021									
X.XX	±0.20	APPROVED	Roger Tsai	03/05/2021									
X.XXX	±0.10						UNIT	mm	SIZE	A3	PART No.	G846AXX2XXX4EU	
ANGULAR	±1°	DWG TYPE		CUST DWG	PROJECT CODE	BHD	SCALE	NA	SHEET	4 OF 4	DWG No.	G846AXX2XXX4EU	
UNLESS OTHERWISE SPECIFIED											REV.	D	