

1-104257-0 ✓ ACTIVE

AMPMODU | AMPMODU MTE

TE Internal #: 1-104257-0

Housing, Receptacle, Wire-to-Board, 11 Position, 2.54 mm [.1 in]
Centerline, Crimp / Insulation Displacement (IDC), 1 Row, Black,
AMPMODU MTE

[View on TE.com >](#)



Connectors > PCB Connectors > Wire-to-Board Connectors > Wire-to-Board Connector Assemblies & Housings



Connector Product Type: **Housing**

Connector & Housing Type: **Receptacle**

Connector System: **Wire-to-Board**

Number of Positions: **11**

Centerline (Pitch): **2.54 mm [.1 in]**

Features

Product Type Features

Connector Product Type	Housing
Connector & Housing Type	Receptacle
Connector System	Wire-to-Board
Sealable	No
Connector & Contact Terminates To	Wire & Cable

Configuration Features

Number of Positions	11
Number of Rows	1

Housing Features

Centerline (Pitch)	2.54 mm [.1 in]
Housing Material	Thermoplastic

Termination Features

Termination Method to Wire & Cable	Crimp, Insulation Displacement (IDC)
------------------------------------	--------------------------------------

Body Features

Primary Product Color	Black
-----------------------	-------

Mechanical Attachment

Mating Retention	With
Connector Mounting Type	Cable Mount (Free-Hanging)



Contact Retention Type Within Housing	Locking Lance
Strain Relief	Without
Panel Mount Feature	Without
Mating Retention Type	Latch
PCB Mount Retention	Without

Contact Features

Contact Current Rating (Max)	3 A
Contact Layout	Inline
Contact Retention Within Housing	With
Contact Type	Socket

Operation/Application

Circuit Application	Signal
---------------------	--------

Usage Conditions

Operating Temperature Range	-65 – 105 °C[-85 – 221 °F]
-----------------------------	----------------------------

Other

EU RoHS Compliance	Compliant
EU ELV Compliance	Compliant

Electrical Characteristics

Insulation Resistance	5000 MΩ
Operating Voltage	267 V
Dielectric Withstanding Voltage (Max)	600 VAC

Dimensions

Connector Height	6.73 mm[.265 in]
Connector Length	27.89 mm[1.098 in]

Industry Standards

UL Flammability Rating	UL 94V-0
Glow Wire Rating	Standard Part - Not Glow Wire

Packaging Features

Packaging Method	Bag
Packaging Quantity	500



Product Compliance





[For compliance documentation, visit the product page on TE.com>](#)

EU RoHS Directive 2011/65/EU	Compliant
EU ELV Directive 2000/53/EC	Compliant
China RoHS 2 Directive MIIT Order No 32, 2016	No Restricted Materials Above Threshold
EU REACH Regulation (EC) No. 1907/2006	Current ECHA Candidate List: JUNE 2024 (241) Candidate List Declared Against: JUNE 2024 (241) Does not contain REACH SVHC
Halogen Content	Not Low Halogen - contains Br or Cl > 900 ppm.
Solder Process Capability	Not applicable for solder process capability

Product Compliance Disclaimer

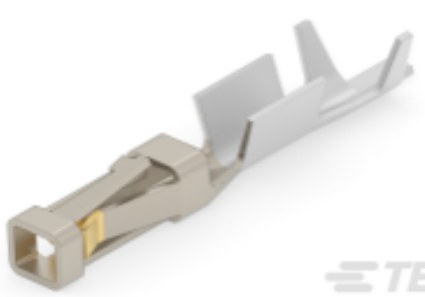
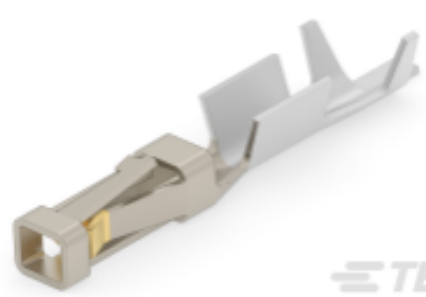
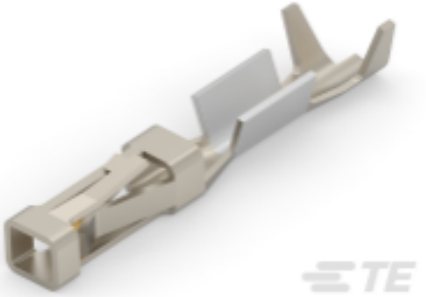
This information is provided based on reasonable inquiry of our suppliers and represents our current actual knowledge based on the information they provided. This information is subject to change. The part numbers that TE has identified as EU RoHS compliant have a maximum concentration of 0.1% by weight in homogenous materials for lead, hexavalent chromium, mercury, PBB, PBDE, DBP, BBP, DEHP, DIBP, and 0.01% for cadmium, or qualify for an exemption to these limits as defined in the Annexes of Directive 2011/65/EU (RoHS2). Finished electrical and electronic equipment products will be CE marked as required by Directive 2011/65/EU. Components may not be CE marked. Additionally, the part numbers that TE has identified as EU ELV compliant have a maximum concentration of 0.1% by weight in homogenous materials for lead, hexavalent chromium, and mercury, and 0.01% for cadmium, or qualify for an exemption to these limits as defined in the Annexes of Directive 2000/53/EC (ELV). Regarding the REACH Regulation, the information TE provides on SVHC in articles for this part number is based on the latest European Chemicals Agency (ECHA) 'Guidance on requirements for substances in articles' posted at this URL: <https://echa.europa.eu/guidance-documents/guidance-on-reach>

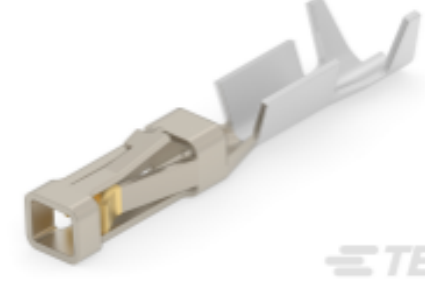
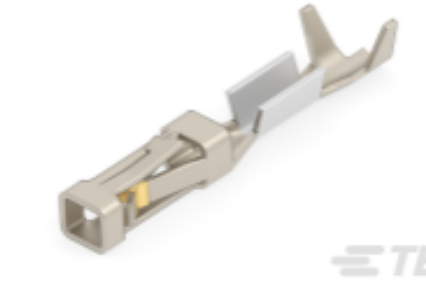
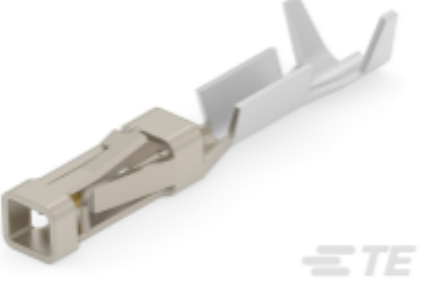
Compatible Parts

 TE Part # 1-104479-0 SHORT POINT CONT 30 DPLX STMPD LF	 TE Part # 104479-9 SHORT POINT CONT 15 DPLX STMPD LF	 TE Part # 1-104480-3 SHORT POINT CONT 30 DPLX STMPD LF	 TE Part # 104479-8 SHORT POINT CONT PLTD SN
 TE Part # 1-104480-2 SHORT POINT CONT 15 DPLX STMPD LF	 TE Part # 1-104481-1 SHORT POINT CONT 30 DPLX STMPD LF	 TE Part # 1-104481-0 SHORT POINT CONT 15 DPLX STMPD LF	 TE Part # 1-103653-0 11 MTE SHRD PIN HSG SR LATCH

Also in the Series | AMPMODU MTE



Connector Caps & Covers(18)



Connector Contacts(27)



Connector Hardware(1)

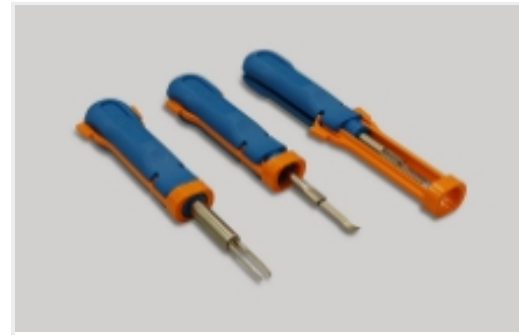

Insertion & Extraction Tools(1)



PCB Headers & Receptacles(444)



Wire-to-Board Connector Assemblies & Housings(298)

Customers Also Bought



TE Part #1658543-1
SOCKET CONT DUPL PLT LP HD-20



TE Part #104257-9
10 MTE RCPT HSG SR LATCH .100



TE Part #5-103635-9
10 MTE HDR SRRRA LTCH.100CL LF

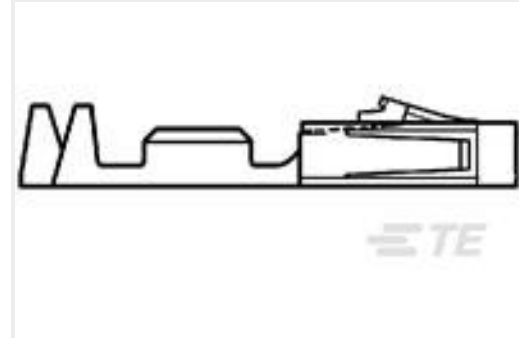

TE Part #1-104480-2
SHORT POINT CONT 15 DPLX STMPD LF



TE Part #1-104257-1
12 MTE RCPT HSG SR LATCH .100

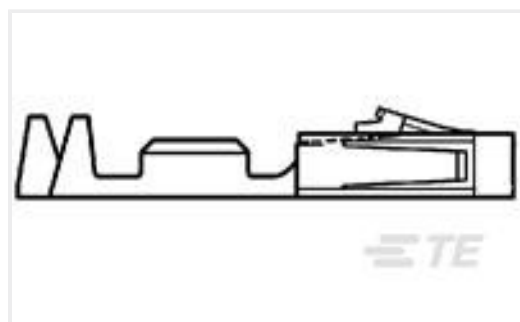

TE Part #1-104480-6
SHORT POINT RECP CONT LP



TE Part #104257-8
09 MTE RCPT HSG SR LATCH .100



TE Part #1-104257-4
15 MTE RCPT HSG SR LATCH .100



TE Part #6-103635-0
11 MTE HDR SRRRA LTCH.100CL LF



TE Part #755336-1
DAHT FASTON 22-14 ASSY



Documents

Product Drawings

[11 MTE RCPT HSG SR LATCH .100](#)

English

CAD Files

[3D PDF](#)

3D

Customer View Model

[ENG_CVM_CVM_1-104257-0_AH.2d_dxf.zip](#)

English

Customer View Model

[ENG_CVM_CVM_1-104257-0_AH.3d_igs.zip](#)

English

Customer View Model

[ENG_CVM_CVM_1-104257-0_AH.3d_stp.zip](#)

English

By downloading the CAD file I accept and agree to the [Terms and Conditions](#) of use.

Datasheets & Catalog Pages

[AMP MODU MTE Section of Catalog 1307819](#)

English

[AMPMODU_INTERCONNECTION_SYSTEM_SECTION5_CONT](#)

English

[AMPMODU MTE INTERCONNECT SYSTEM](#)

English

Product Specifications

[Application Specification](#)

English