

52284-3 ✓ ACTIVE



## PIDG

TE Internal #: 52284-3

Closed Ring Tongue Terminal, 20 AWG, #10 Stud Size, 4.82 mm [.19 in] Stud Diameter, Closed Barrel, Offset, Tin, Partially Insulated, PIDG

[View on TE.com >](#)

Terminals & Splices > Ring Terminals > PIDG Offset Ring Tongue Terminals

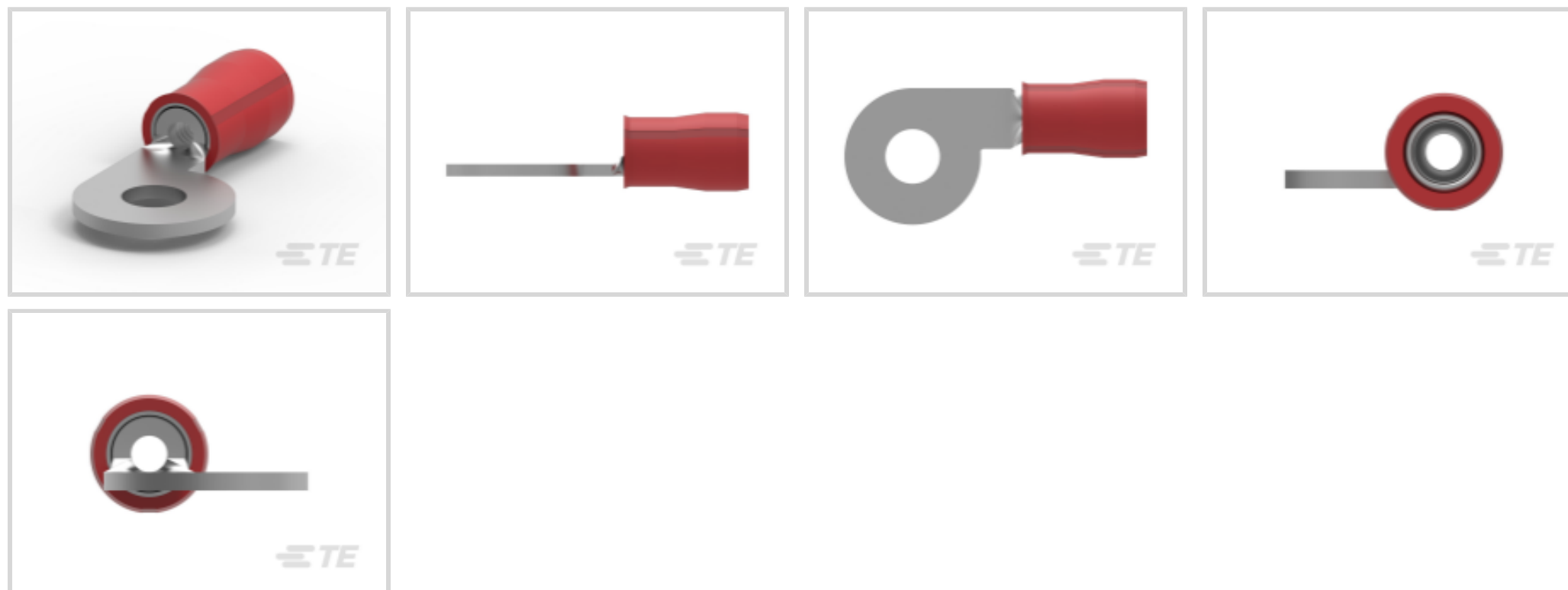

Ring Terminal Product Type: Closed Ring Tongue Terminal

Wire Size: 1186 CMA

Stud Size: #10

[All PIDG Offset Ring Tongue Terminals \(6\)](#)

## Features

### Product Type Features

Ring Terminal Product Type	Closed Ring Tongue Terminal
Stud Size	#10
Sealable	No
Wire Insulation Support Retention Type	Insulation Restriction

### Dimensions

Wire Size	1186 CMA
Stud Diameter	4.82 mm [.19 in]
Tongue Thickness	.79 mm [.031 in]
Product Length	24.03 mm [.946 in]
Compatible Insulation Diameter (Max)	2.79 mm [.11 in]
Compatible Insulation Diameter Range	1.17 – 2.79 mm [.046 – .11 in]

### Contact Features

Barrel Type	Closed
Terminal Orientation	Offset



Terminal Plating Material	Tin
---------------------------	-----

### Usage Conditions

Insulation Option	Partially Insulated
-------------------	---------------------

Operating Temperature Range	105 °C[221 °F]
-----------------------------	----------------

### Operation/Application

Compatible With Wire Base Material	Copper
------------------------------------	--------

Compatible With Wire Plating Material	Tin
---------------------------------------	-----

### Packaging Features

Packaging Method	Loose Piece
------------------	-------------

Packaging Quantity	1000
--------------------	------

### Other

EU RoHS Compliance	Compliant
--------------------	-----------

EU ELV Compliance	Compliant
-------------------	-----------

### Configuration Features

Number of Holes	1
-----------------	---

### Electrical Characteristics

Voltage Rating	300 V
----------------	-------

### Body Features

Insulation Sleeve Color	Red
-------------------------	-----

Stripe Color	Red
--------------	-----

### Mechanical Attachment

Wire Insulation Support	With
-------------------------	------

### Industry Standards

Government Qualified Terminal	No
-------------------------------	----

### Product Compliance

[For compliance documentation, visit the product page on TE.com>](#)

EU RoHS Directive 2011/65/EU	Compliant
------------------------------	-----------

EU ELV Directive 2000/53/EC	Compliant
-----------------------------	-----------

China RoHS 2 Directive MIIT Order No 32, 2016	No Restricted Materials Above Threshold
---	---

EU REACH Regulation (EC) No. 1907/2006	Current ECHA Candidate List: JUNE 2024 (241)
--	--









Candidate List Declared Against: JUNE 2024 (241)  
Does not contain REACH SVHC

Halogen Content	Low Halogen - Br, Cl, F, I < 900 ppm per homogenous material. Also BFR/CFR/PVC Free
Solder Process Capability	Not applicable for solder process capability

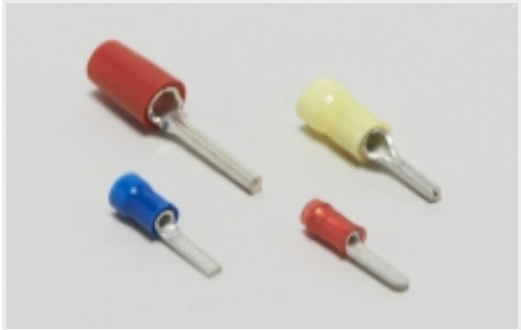
Product Compliance Disclaimer

This information is provided based on reasonable inquiry of our suppliers and represents our current actual knowledge based on the information they provided. This information is subject to change. The part numbers that TE has identified as EU RoHS compliant have a maximum concentration of 0.1% by weight in homogenous materials for lead, hexavalent chromium, mercury, PBB, PBDE, DBP, BBP, DEHP, DIBP, and 0.01% for cadmium, or qualify for an exemption to these limits as defined in the Annexes of Directive 2011/65/EU (RoHS2). Finished electrical and electronic equipment products will be CE marked as required by Directive 2011/65/EU. Components may not be CE marked. Additionally, the part numbers that TE has identified as EU ELV compliant have a maximum concentration of 0.1% by weight in homogenous materials for lead, hexavalent chromium, and mercury, and 0.01% for cadmium, or qualify for an exemption to these limits as defined in the Annexes of Directive 2000/53/EC (ELV). Regarding the REACH Regulation, the information TE provides on SVHC in articles for this part number is based on the latest European Chemicals Agency (ECHA) 'Guidance on requirements for substances in articles' posted at this URL: <https://echa.europa.eu/guidance-documents/guidance-on-reach>

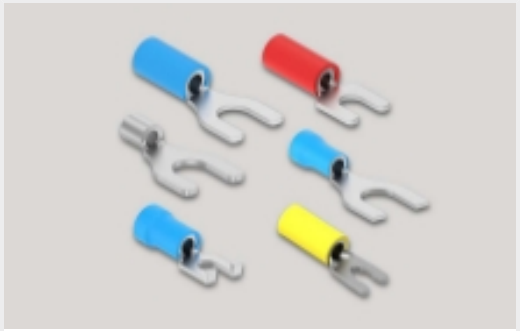
Also in the Series | PIDG

 Compression Connectors(17)	 Crimp Wire Pins, Tabs & Ferrules(41)	 Hand Crimping Tools(2)	 Knife Disconnects(11)
 Quick Disconnects(32)	 Ring Terminals(588)	 Spade Terminals(228)	 Special Purpose Terminals(1)



Splices(39)

## Customers Also Bought

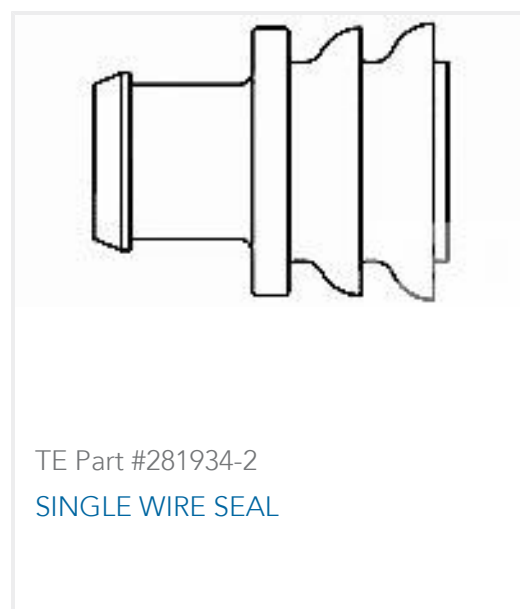
TE Part #DT04-2P  
REC, 2P, GRY, NTE Part #W2S  
Wedgelocks: DEUTSCH DTTE Part #0460-202-16141  
DEUTSCH Solid ContactsTE Part #282104-1  
AMP SUPERSEAL 1.5MM,  
CONNECTOR HOUSINGTE Part #DT06-2S  
PLG, 2P, GRY, NTE Part #281934-2  
SINGLE WIRE SEALTE Part #114017-ZZ  
SEALING PLUG, SIZE 12/16, WHT

## Documents

### Product Drawings

[N PIDG RING OFFSET 20 10](#)

English

### CAD Files

[3D PDF](#)

3D

Customer View Model

[ENG\\_CVM\\_CVM\\_52284-3\\_H.2d\\_dxf.zip](#)

English

Customer View Model

[ENG\\_CVM\\_CVM\\_52284-3\\_H.3d\\_igs.zip](#)

English

Customer View Model

[ENG\\_CVM\\_CVM\\_52284-3\\_H.3d\\_stp.zip](#)

English

By downloading the CAD file I accept and agree to the [Terms and Conditions](#) of use.

52284-3

Closed Ring Tongue Terminal, 20 AWG, #10 Stud Size, 4.82 mm [.19 in] Stud Diameter, Closed Barrel, Offset, Tin, Partially Insulated, PIDG

