

34855 ✓ ACTIVE

PLASTI-GRIP

TE Internal #: 34855

Closed Ring Tongue Terminal, 12 – 10 AWG, 1/4 / M6 Stud Size, 6.35 mm [.25 in] Stud Diameter, Closed Barrel, Straight, Tin, PLASTI-GRIP

[View on TE.com >](#)



Terminals & Splices > Ring Terminals

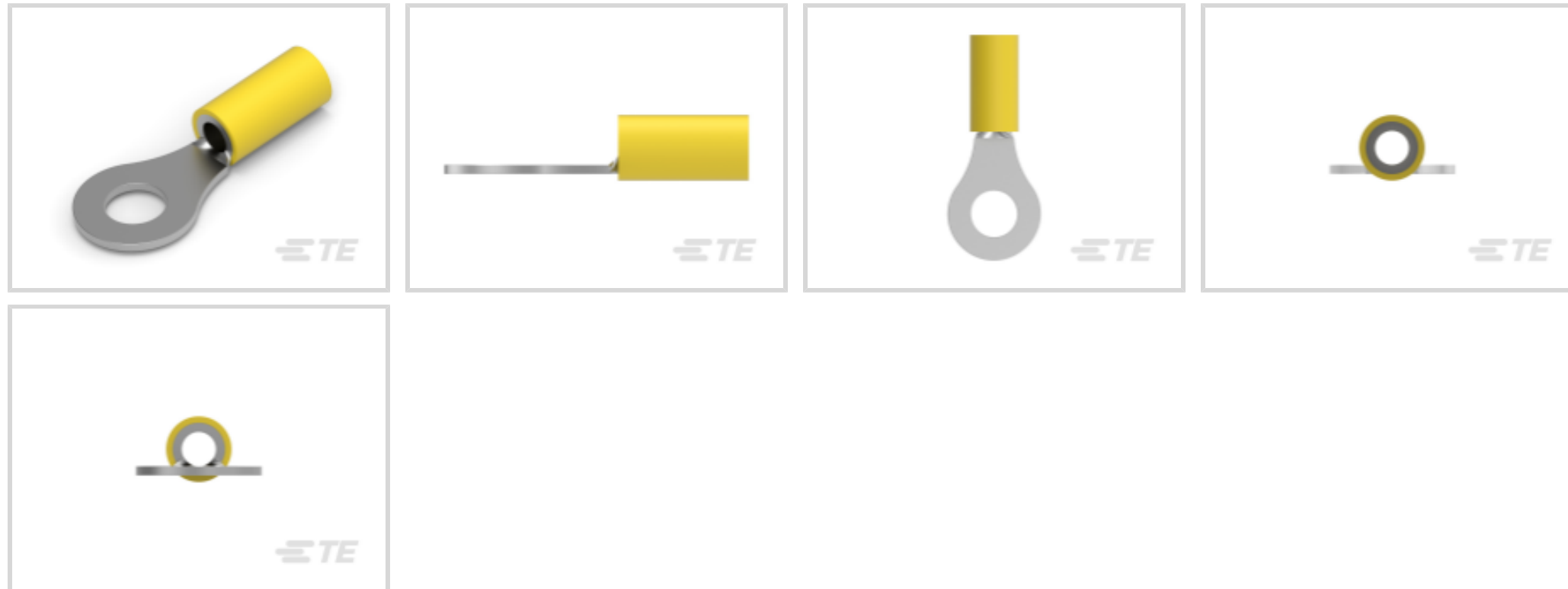

Ring Terminal Product Type: Closed Ring Tongue Terminal

Wire Size: 5180 – 13100 CMA

Stud Size: 1/4, M6

Features

Product Type Features

Ring Terminal Product Type	Closed Ring Tongue Terminal
Stud Size	1/4, M6
Sealable	No
Wire Insulation Support Retention Type	Insulation Support

Dimensions

Wire Size	5180 – 13100 CMA
Stud Diameter	6.35 mm[.25 in]
Tongue Thickness	.99 mm[.039 in]
Product Length	33.71 mm[1.33 in]
Compatible Insulation Diameter (Max)	6.35 mm[.25 in]
Compatible Insulation Diameter Range	3.81 – 6.35 mm[.15 – .25 in]

Contact Features

Barrel Type	Closed
Terminal Orientation	Straight
Terminal Plating Material	Tin

Usage Conditions

Insulation Option	Partially Insulated
Operating Temperature Range	105 °C[221 °F]

Operation/Application

Compatible With Wire Base Material	Copper
Compatible With Wire Plating Material	Tin

Packaging Features

Packaging Method	Loose Piece
Packaging Quantity	500

Other

EU RoHS Compliance	Compliant
EU ELV Compliance	Compliant

Configuration Features

Number of Holes	1
-----------------	---

Electrical Characteristics

Voltage Rating	600 V
----------------	-------

Body Features

Product Weight	2.408 g
----------------	---------

Mechanical Attachment

Wire Insulation Support	With
-------------------------	------

Industry Standards

Government Qualified Terminal	No
-------------------------------	----

Product Compliance

[For compliance documentation, visit the product page on TE.com>](#)

EU RoHS Directive 2011/65/EU	Compliant
EU ELV Directive 2000/53/EC	Compliant
China RoHS 2 Directive MIIT Order No 32, 2016	No Restricted Materials Above Threshold
EU REACH Regulation (EC) No. 1907/2006	Current ECHA Candidate List: JUNE 2024 (241) Candidate List Declared Against: JUNE 2024 (241) Does not contain REACH SVHC



Halogen Content Not Low Halogen - contains Br or Cl > 900 ppm.

Solder Process Capability Not applicable for solder process capability

Product Compliance Disclaimer

This information is provided based on reasonable inquiry of our suppliers and represents our current actual knowledge based on the information they provided. This information is subject to change. The part numbers that TE has identified as EU RoHS compliant have a maximum concentration of 0.1% by weight in homogenous materials for lead, hexavalent chromium, mercury, PBB, PBDE, DBP, BBP, DEHP, DIBP, and 0.01% for cadmium, or qualify for an exemption to these limits as defined in the Annexes of Directive 2011/65/EU (RoHS2). Finished electrical and electronic equipment products will be CE marked as required by Directive 2011/65/EU. Components may not be CE marked. Additionally, the part numbers that TE has identified as EU ELV compliant have a maximum concentration of 0.1% by weight in homogenous materials for lead, hexavalent chromium, and mercury, and 0.01% for cadmium, or qualify for an exemption to these limits as defined in the Annexes of Directive 2000/53/EC (ELV). Regarding the REACH Regulation, the information TE provides on SVHC in articles for this part number is based on the latest European Chemicals Agency (ECHA) 'Guidance on requirements for substances in articles' posted at this URL: <https://echa.europa.eu/guidance-documents/guidance-on-reach>

Compatible Parts

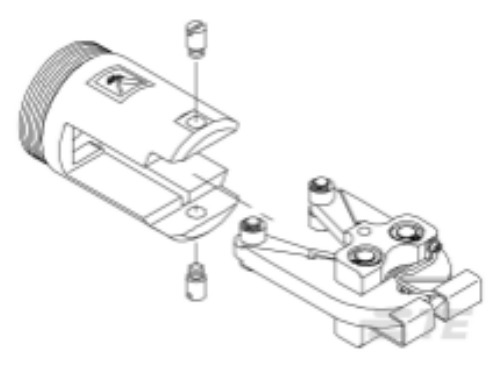

TE Part # 679300-1
1210 PIDG CRIMP HEAD



TE Part # 59824-1
TETRA-CRIMP PIDG PG FASTON 22-10 ASSY



TE Part # 58433-3
PRO CR ASSY, RBY IS9252



TE Part # 59239-4
HHHT PIDG PG 12-10 ASSY



TE Part # 539691-2
ERGO DIE R.B.Y



TE Part # 58423-1
DIE, RBY IS9252



TE Part # 2063030-1
SDE DIESET, RBY, UL



TE Part # 2217330-1
KIT, BTLI, 4 TON, NA



TE Part # 47808-6
DIES PIDG 12-10 DIE SET



TE Part # 169400
CERTI-LOK FRAME W/O DIES



TE Part # 169404
CERTI-LOK DIE

Also in the Series | **PLASTI-GRIP**



Compression Connectors(3)



Crimp Wire Pins, Tabs & Ferrules(18)

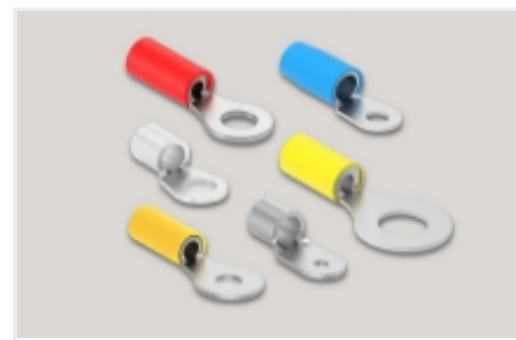

Ring Terminals(297)

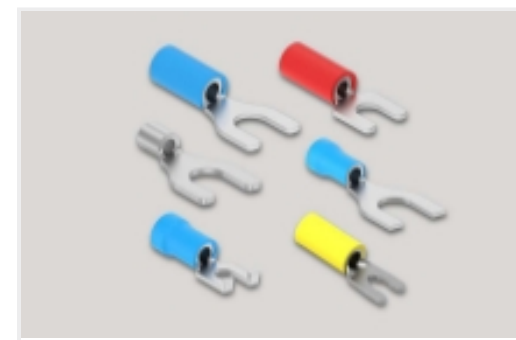

Spade Terminals(157)



Splices(44)

Customers Also Bought



TE Part #898369-000
RT-1145-OX-75-0



TE Part #5745782-4
15 MSFL RCPT RA 318 (IN,FM)



TE Part #1-175194-3
DYNAMIC D-3 REC CONT/S AU 0.76



TE Part #34854
TERMINAL,PG R 12-10 10



TE Part #1218434-2
R/A RCP ASSY 15 POS SER 109

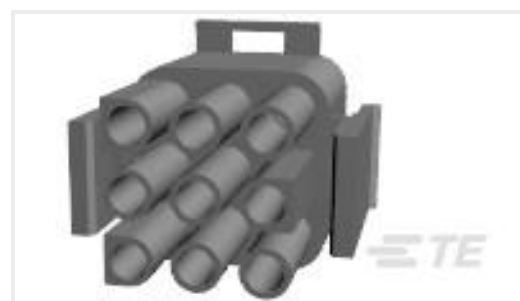

TE Part #1586844-1
09P UMNL PLUG HSG NATL, GW

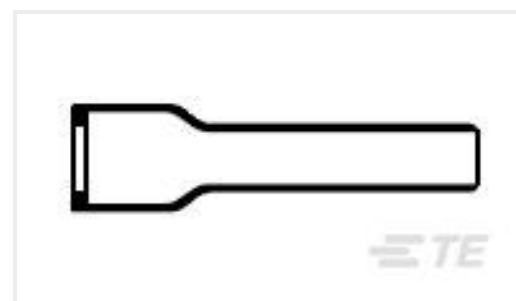

TE Part #811175-000
202D232-12-0



TE Part #4-1462039-2
IM41CGR=IM RELAY 100mW 3V BIS

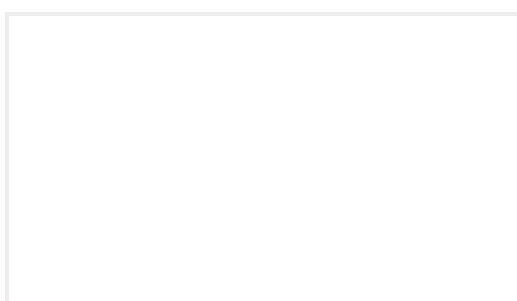

TE Part #300397-000
101A073-25/225-0

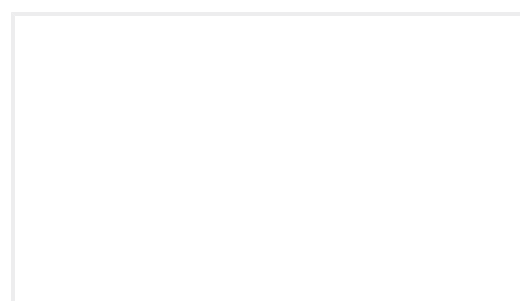

TE Part #40-A756-000-000
723 HTEC INSULATION INSERT, 5+2-PIN

Documents



Product Drawings

[TERMINAL,PG R 12-10 1/4](#)

English

CAD Files

Customer View Model

[ENG_CVM_CVM_34855_AA.2d_dxf.zip](#)

English

3D PDF

3D

Customer View Model

[ENG_CVM_CVM_34855_AA.3d_igs.zip](#)

English

Customer View Model

[ENG_CVM_CVM_34855_AA.3d_stp.zip](#)

English

By downloading the CAD file I accept and agree to the [Terms and Conditions](#) of use.

Product Specifications

[Application Specification](#)

English

Agency Approvals

[UL Report](#)

English

[UL Report](#)

English

[UL Report](#)

English