

Nov.1.2024 Copyright 2024 HIROSE ELECTRIC CO., LTD. All Rights Reserved.  
In case of consideration for using Automotive equipment / device which demand high reliability, kindly contact our sales window correspondents.

TO  
□  
□  
□  
□

	DESCRIPTION OF REVISIONS	BY	CHKD	DATE	COUNT	DESCRIPTION OF REVISIONS	BY	CHKD	DATE
△					△				
△					△				
<b>APPLICABLE STANDARD</b>									
RATING	OPERATING TEMPERATURE RANGE	- 35 °C TO 85 °C(NOTE1)			STORAGE TEMPERATURE RANGE	- 10 °C TO 60 °C			
	VOLTAGE	30 V AC			APPLICABLE CONNECTOR	DF30*-60DP-0.4V(**)			
	CURRENT	0.3 A							
<b>SPECIFICATIONS</b>									
ITEM		TEST METHOD			REQUIREMENTS			QT	AT
<b>CONSTRUCTION</b>									
GENERAL EXAMINATION		VISUALLY AND BY MEASURING INSTRUMENT.			ACCORDING TO DRAWING.			X	X
MARKING		CONFIRMED VISUALLY.						X	X
<b>ELECTRICAL CHARACTERISTICS</b>									
CONTACT RESISTANCE		100 mA (DC OR 1000 Hz).			100 mΩ MAX.			X	-
INSULATION RESISTANCE		100 V DC.			50 MΩ MIN.			X	-
VOLTAGE PROOF		100 V AC FOR 1 min.			NO FLASHOVER OR BREAKDOWN.			X	-
<b>MECHANICAL CHARACTERISTICS</b>									
MECHANICAL OPERATION		50 TIMES INSERTIONS AND EXTRACTIONS.			① CONTACT RESISTANCE: 100 mΩ MAX. ② NO DAMAGE, CRACK AND LOOSENESS, OF PARTS.			X	-
VIBRATION		FREQUENCY 10 TO 55 Hz, SINGLE AMPLITUDE 0.75 mm, 10 CYCLES OF EACH 3 AXIAL DIRECTION FOR 5 min.			① NO ELECTRICAL DISCONTINUITY OF 1 μs. ② NO DAMAGE, CRACK AND LOOSENESS, OF PARTS.			X	-
SHOCK		490 m/s <sup>2</sup> DURATION OF PULSE 11 ms AT 3 TIMES FOR 3 DIRECTIONS.			① NO ELECTRICAL DISCONTINUITY OF 1 μs. ② NO DAMAGE, CRACK AND LOOSENESS, OF PARTS.			X	-
<b>ENVIRONMENTAL CHARACTERISTICS</b>									
DAMP HEAT (STEADY STATE)		EXPOSED AT 40±2 °C, 90 TO 95 %, 96 h.			① CONTACT RESISTANCE: 100 mΩ MAX. ② INSULATION RESISTANCE: 25 MΩ MIN. ③ NO DAMAGE, CRACK AND LOOSENESS, OF PARTS.			X	-
RAPID CHANGE OF TEMPERATURE		TEMPERATURE -55→ 5 TO 35→85→ 5 TO 35 °C TIME 30→10 TO 15→30→10 TO 15 min UNDER 5 CYCLES.			① CONTACT RESISTANCE: 100 mΩ MAX. ② INSULATION RESISTANCE: 50 MΩ MIN. ③ NO DAMAGE, CRACK AND LOOSENESS, OF PARTS.			X	-
CORROSION SALT MIST		EXPOSED IN 5% SALT WATER SPRAY FOR 48 h. (TEST STANDARD:IEC60068)			① CONTACT RESISTANCE: 100 mΩ MAX. ② NO HEAVY CORROSION.			X	-
SULPHUR DIOXIDE		EXPOSED IN 25 PPM FOR 96h. (TEST STANDARD:IEC60068)			① CONTACT RESISTANCE: 100 mΩ MAX. ② NO HEAVY CORROSION.			X	-
REMARKS NOTE1: INCLUDE THE TEMPERATURE RISING BY CURRENT.					DRAWN F.MATSUKI '05.01.28	DESIGNED <i>A. Takahashi</i> '05.01.31	CHECKED <i>T. Sakata</i> '05.01.31	APPROVED <i>T. Sakata</i> '05.01.31	RELEASED
Unless otherwise specified, refer to IEC60512.									
Note QT: Qualification Test AT: Assurance Test X: Applicable Test									
<b>HRS</b> HIROSE ELECTRIC CO., LTD.					<b>SPECIFICATION SHEET</b>			PART NO. DF30FC-60DS-0.4V(81)	
CODE NO.(OLD) CL		DRAWING NO. ELC4-303169-04			CODE NO. CL684-1082-3-81			1/1	

Nov.1.2024 Copyright 2024 HIROSE ELECTRIC CO., LTD. All Rights Reserved.  
In case of consideration for using Automotive equipment / device which demand high reliability, kindly contact our sales window correspondents.

1	2		3		4				
COUNT	DESCRIPTION OF REVISIONS	BY	CHKD	DATE	COUNT	DESCRIPTION OF REVISIONS	BY	CHKD	DATE
△	4	RE-H-06664	YM	TS	04.12.17	△			. .
△						△			. .
△						△			. .

■ NOTES WHEN MATING DF30 SERIES CONNECTORS.

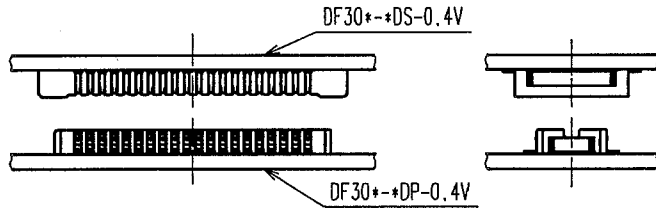

FIGURE-1

PLEASE LOCATE EACH CONNECTOR IN PARALLEL WHEN YOU PUT THEM IN MATING POSITION.

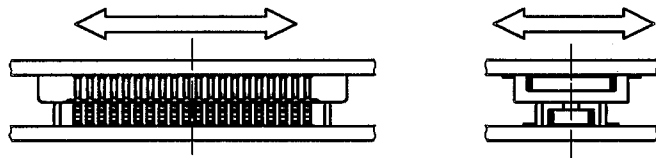

FIGURE-2

THE INSULATOR WILL BE DAMAGED AND THE CONTACTS WILL BE DEFORMED IF THE CONNECTORS ARE LOCATED INCLINED AND MATED BY EXCESSIVE FORCE.

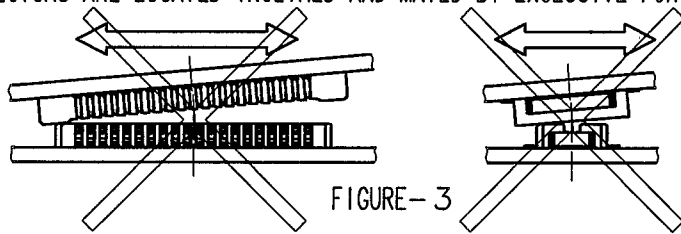

FIGURE-3

WHEN YOU LOCATE TWO CONNECTORS IN A PROPER POSITION, THEY WILL GO DOWN SLIGHTLY AT A LOWER LEVEL AND YOU WILL FIND THAT THEY GET LOCATED CORRECTLY. PLEASE MATE EACH CONNECTOR IN PARALLEL AFTER YOU CONFIRMED THAT THEY GO DOWN LOWER TO SOME EXTENT.

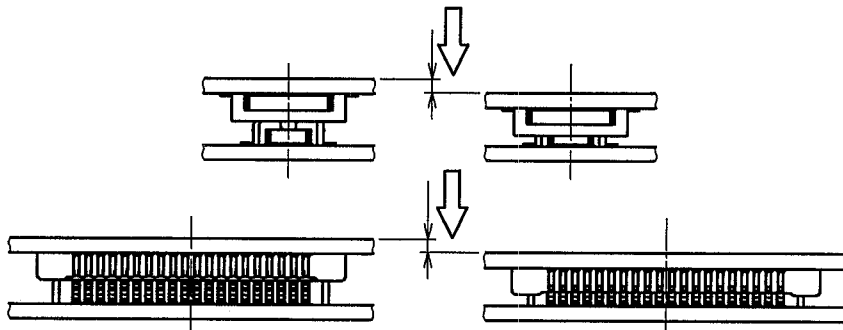

FIGURE-4

THE MATED CONDITIONS CAN BE RELEASED BY A DROP IMPACT OR THE APPLIED FORCE CAUSED BY FPC-HANDLING. FIX THE CONNECTORS BY APPLYING PRESSURE IN THE MATING DIRECTION WITH THE DEVICE OR A BUFFER MATERIAL.

CODE NO. (OLD)		DRAWN Y.MICHIDA 04.12.16	DESIGNED A.TAKAHASHI 04.12.16	CHECKED T.SAKATA 04.12.16	APPROVED T.OMA 04.12.16	RELEASED
NOTES WHEN MATING						
DRAWING NO. EDSC4-830174		PART NO. DF30 Series				
SCALE FREE : 1		CODE NO. CL684				1/3
UNITS mm		HIROSE ELECTRIC CO., LTD.				

TO



Nov.1.2024 Copyright 2024 HIROSE ELECTRIC CO.,LTD. All Rights Reserved.  
In case of consideration for using Automotive equipment / device which demand high reliability, kindly contact our sales window correspondents.

1			2			3			4					
COUNT	DESCRIPTION OF REVISIONS	BY	CHKD	DATE	COUNT	DESCRIPTION OF REVISIONS	BY	CHKD	DATE	COUNT	DESCRIPTION OF REVISIONS	BY	CHKD	DATE
△					△									.
△					△									.
△					△									.

■ NOTES WHEN EXTRACTING

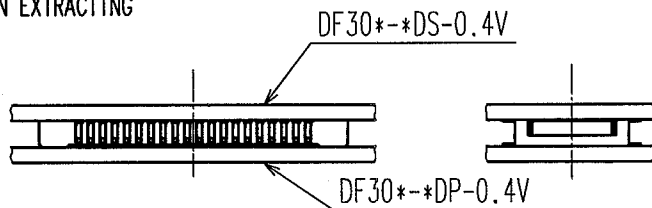

FIGURE-5

WHEN YOU EXTRACT CONNECTORS, PLEASE EXTRACT IN PARALLEL.

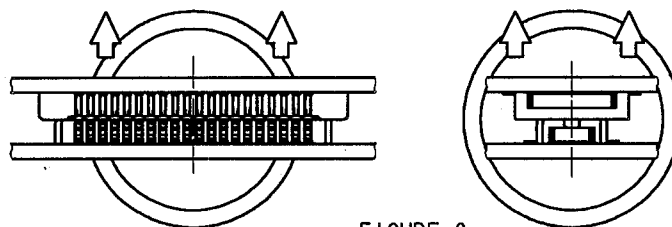

FIGURE-6

⚠ IF YOU'RE UNABLE TO EXTRACT IN PARALLEL DUE TO SET STRUCTURE OR SPACE, PLEASE EXTRACT AS FIGURE-7 (IN LONGER DIMENSION). PLEASE BE CAREFUL NOT TO DAMAGE CONTACTS AT SIDES, WHERE STRESS IS LIKELY TO GATHER WHEN CONNECTORS ARE MOUNTED ON SOFT FPC.

⚠ ESPECIALLY, PLEASE DO NOT EXTRACT FROM THE CORNER AS FIGURE-8. IT GIVES CRITICAL STRESS TO THE CONTACTS ON THE CROSS CORNER.

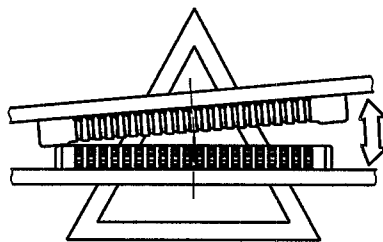

FIGURE-7

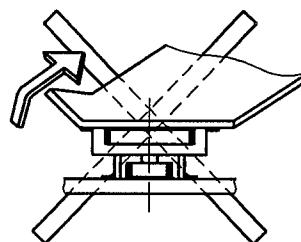

FIGURE-8

⚠ PLEASE DO NOT EXTRACT AS FIGURE-9. THE STRESS CONCENTRATES ON ONE ROW, AND MIGHT DAMAGE CONNECTORS TO MALFUNCTION.

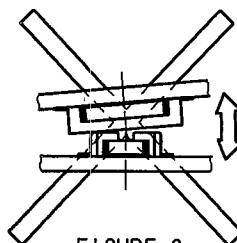

FIGURE-9

CODE NO. (OLD)		DRAWN	DESIGNED	CHECKED	APPROVED	RELEASED
		Y.MICHIDA	A.TAKAHASHI	T.SAKATA	T.OMA	
NOTES WHEN EXTRACTING		04.12.16	04.12.16	04.12.16	04.12.16	
DRAWING NO.		PART NO.				
EDSC4-830174		DF30 Series				
SCALE FREE : 1		CODE NO.				
UNITS mm		CL684				
HRS HIROSE ELECTRIC CO.,LTD.		2/3				

Nov.1.2024 Copyright 2024 HIROSE ELECTRIC CO., LTD. All Rights Reserved.  
 In case of consideration for using Automotive equipment / device which demand high reliability, kindly contact our sales window correspondents.

1	2				3				4			
COUNT	DESCRIPTION OF REVISIONS			BY	CHKD	DATE	COUNT	DESCRIPTION OF REVISIONS		BY	CHKD	DATE
△							△					. .
△							△					. .
△							△					. .

⚠ WHEN FPC IS SOFT, STRESS IS CONCENTRATED ON THE CONTACTS AT CORNERS.  
 PLEASE PAY ATTENTION TO THIS POINT AND DO NOT UNMATE CONNECTORS FROM CORNERS AS FIGURE-10.  
 THIS GIVES SERIOUS DAMAGE ON CONTACTS, AND OCCURS SOLDER PEEL-OFF OR CONTACT COME-OFF.

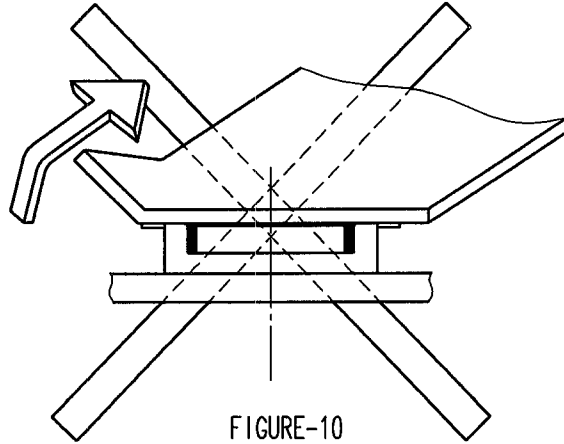

FIGURE-10

IF YOU MOUNT PLUG CONNECTOR ON FPC, CONTACTS MIGHT COME OFF FROM HOUSING MOLD.

CONTACT MIGHT COME OFF FROM HOUSING MOLD.

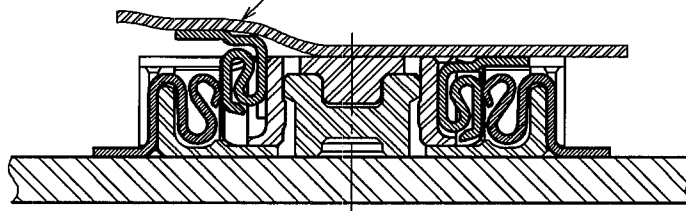

FIGURE-11

IN CASE YOU MOUNT RECEPTACLE CONNECTOR ON FPC, THERE IS NO RISK OF CONTACT COME-OFF.  
 HIROSE RECOMMEND THAT RECEPTACLE IS MOUNTED ON FPC.

IN ORDER TO AVOID THIS RISK, IT IS RECOMMENDED THAT YOU MOUNT RECEPTACLE CONNECTOR ON FPC.

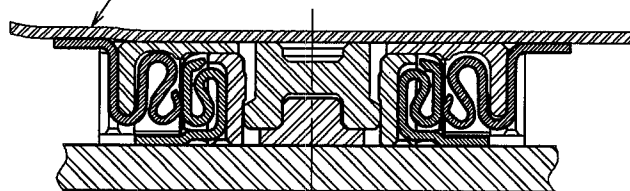

FIGURE-12

CODE NO. (OLD)		DRAWN	DESIGNED	CHECKED	APPROVED	RELEASED
		Y.MICHIDA	A.TAKAHASHI	T.SAKATA	T.OMA	
NOTES WHEN EXTRACTING (SUPPLEMENTARY DATA)		04.12.16	04.12.16	04.12.16	04.12.16	
 SCALE FREE : 1 UNITS mm	DRAWING NO.		PART NO.			
	EDSC4-830174		DF30 Series			
 HIROSE ELECTRIC CO.,LTD.		CODE NO.			CL684 3/3	



Nov.1.2024 Copyright 2024 HIROSE ELECTRIC CO., LTD. All Rights Reserved.  
In case of consideration for using Automotive equipment / device which demand high reliability, kindly contact our sales window correspondents.

1			2			3			4					
COUNT	DESCRIPTION OF REVISIONS	BY	CHKD	DATE	COUNT	DESCRIPTION OF REVISIONS	BY	CHKD	DATE	COUNT	DESCRIPTION OF REVISIONS	BY	CHKD	DATE
△					△					△				
△					△					△				
△					△					△				

Temperatuer (°C)

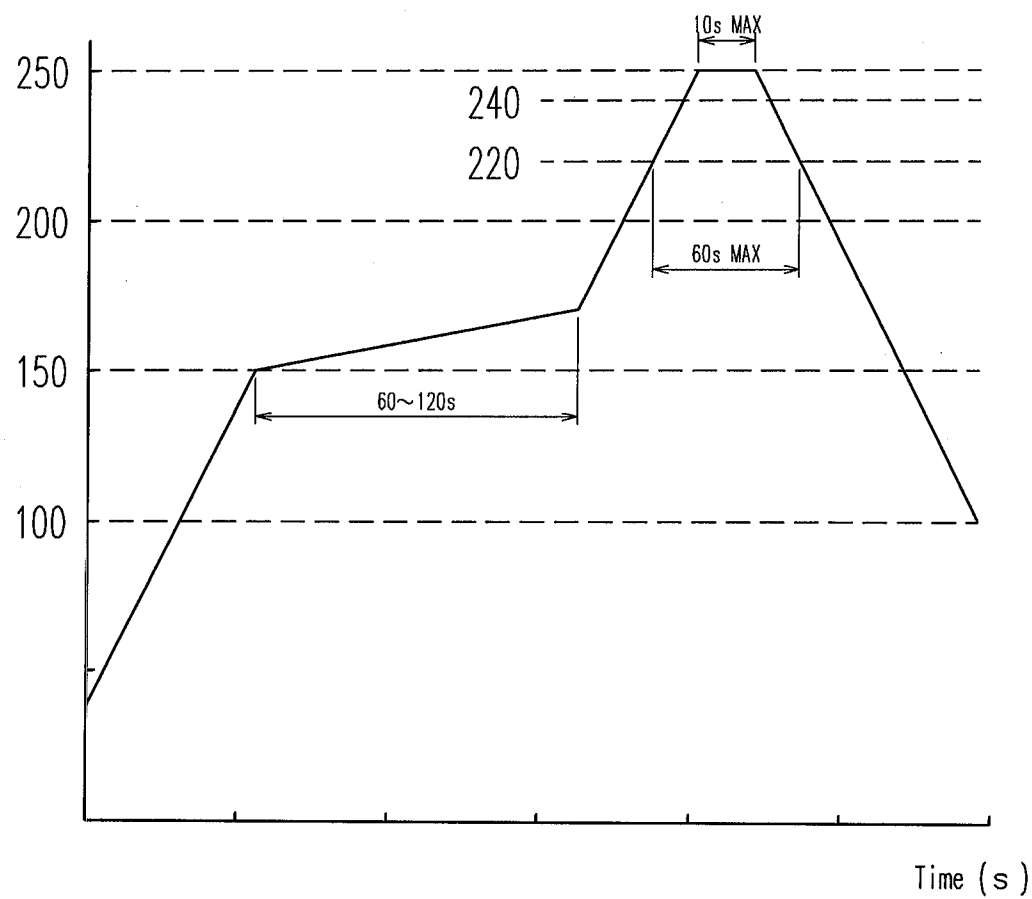

NOTE 1.REFLOW SYSTEM : IR REFLOW (AIR OR N<sub>2</sub> GAS)  
2.PERFORMING REFLOW : TWICE MAX

NO.	MATERIAL	FINISH, REMARKS	NO.	MATERIAL	FINISH, REMARKS
CODE NO. (OLD)			DRAWN	DESIGNED	CHECKED
			T.NISHI	W.Fukuchi	J. Jomika
			03.08.19	03.08.19	03.08.20
					APPROVED
					J. Ona
					RELEASED
DRAWING NO.			PART NO.		
EDC4-830116			DF30-*DS/DP-0.4V		
SCALE			CODE NO.		
FREE			CL684		
UNITS					
mm					

TO

