

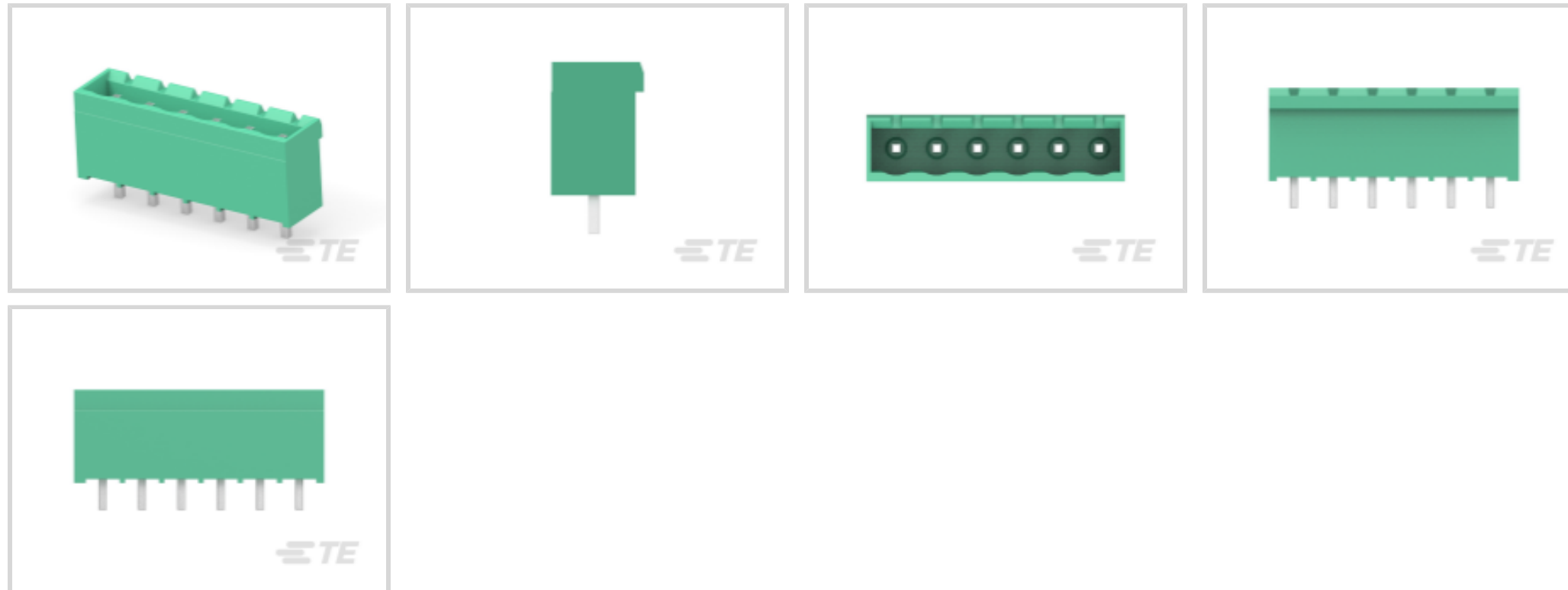

Connectors > Terminal Blocks & Strips > PCB Terminal Blocks



EU RoHS Compliance: **Compliant**

EU ELV Compliance: **Compliant**

Terminal Block Connector Type: **Header**

Connector System: **Wire-to-Board**

Number of Positions: **6**

Features

Other

EU RoHS Compliance	Compliant
EU ELV Compliance	Compliant

Product Type Features

Header Type	Fully Shrouded
Terminal Block Connector Type	Header
Connector System	Wire-to-Board
Connector & Contact Terminates To	Printed Circuit Board

Configuration Features

Stacking Configuration	Side Stackable
Number of Positions	6
Number of Rows	1

Electrical Characteristics

Operating Voltage	300 VAC
-------------------	---------



Body Features

Primary Product Color	Green
Product Orientation	Vertical

Contact Features

Contact Mating Area Plating Material	Tin
Contact Base Material	Copper Magnesium
Contact Current Rating (Max)	15 A

Termination Features

Termination Method to PCB	Through Hole - Solder
Termination Post & Tail Length	3.5 mm[.138 in]

Mechanical Attachment

Connector Mounting Type	Board Mount
-------------------------	-------------

Housing Features

Housing Material	PA 66
Centerline (Pitch)	5.08 mm[.2 in]

Dimensions

Wire Size	30 – 12 AWG
-----------	-------------

Usage Conditions

Operating Temperature Range	-40 – 105 °C[-40 – 221 °F]
-----------------------------	----------------------------

Operation/Application

Circuit Application	Power & Signal
---------------------	----------------

Packaging Features

Packaging Quantity	100
--------------------	-----

Product Compliance

[For compliance documentation, visit the product page on TE.com>](#)

EU RoHS Directive 2011/65/EU	Compliant
EU ELV Directive 2000/53/EC	Compliant
China RoHS 2 Directive MIIT Order No 32, 2016	No Restricted Materials Above Threshold
EU REACH Regulation (EC) No. 1907/2006	Current ECHA Candidate List: JUNE 2024 (241) Candidate List Declared Against: JUNE 2024 (241)

Does not contain REACH SVHC

Halogen Content

Low Halogen - Br, Cl, F, I < 900 ppm per homogenous material. Also BFR/CFR/PVC Free

Solder Process Capability

Wave solder capable to 240°C

Product Compliance Disclaimer

This information is provided based on reasonable inquiry of our suppliers and represents our current actual knowledge based on the information they provided. This information is subject to change. The part numbers that TE has identified as EU RoHS compliant have a maximum concentration of 0.1% by weight in homogenous materials for lead, hexavalent chromium, mercury, PBB, PBDE, DBP, BBP, DEHP, DIBP, and 0.01% for cadmium, or qualify for an exemption to these limits as defined in the Annexes of Directive 2011/65/EU (RoHS2). Finished electrical and electronic equipment products will be CE marked as required by Directive 2011/65/EU. Components may not be CE marked. Additionally, the part numbers that TE has identified as EU ELV compliant have a maximum concentration of 0.1% by weight in homogenous materials for lead, hexavalent chromium, and mercury, and 0.01% for cadmium, or qualify for an exemption to these limits as defined in the Annexes of Directive 2000/53/EC (ELV). Regarding the REACH Regulation, the information TE provides on SVHC in articles for this part number is based on the latest European Chemicals Agency (ECHA) 'Guidance on requirements for substances in articles' posted at this URL: <https://echa.europa.eu/guidance-documents/guidance-on-reach>

Compatible Parts

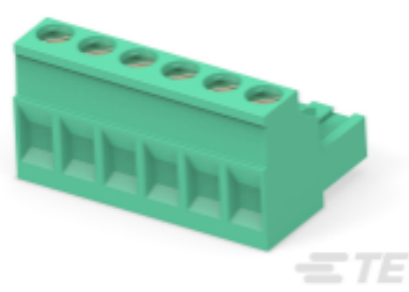

TE Part # 796634-6
6 POS 5.08MM R/A PLUG, TRM BLK

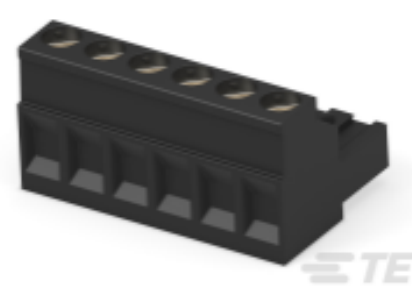

TE Part # 796635-6
6 POS 5.08MM R/A PLUG, TRM BLK

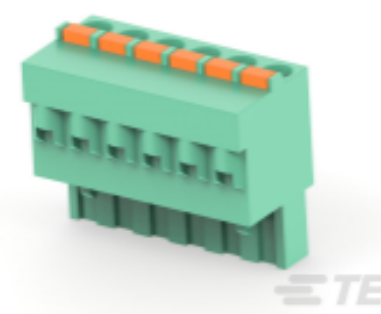

TE Part # 1986262-6
6 POS PLUG SPRING CONN, PITCH 5.08

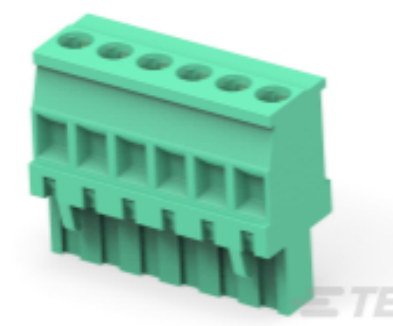

TE Part # 284047-6
TERMI-BLOK VERTICAL PLUG STACK

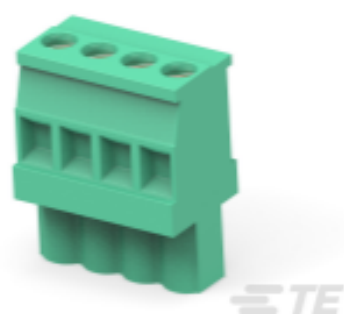

TE Part # 284041-6
TERMINAL BLOCK VERTICAL PLUG S

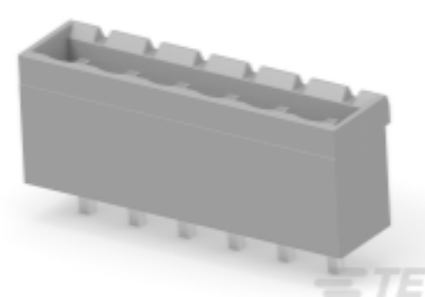

TE Part # 1546111-6
EUROSTYLE TB, HEADER, GREY, 6 POS

Customers Also Bought

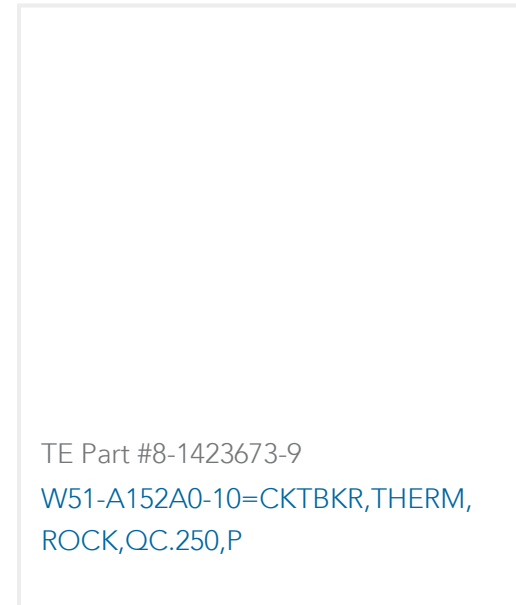
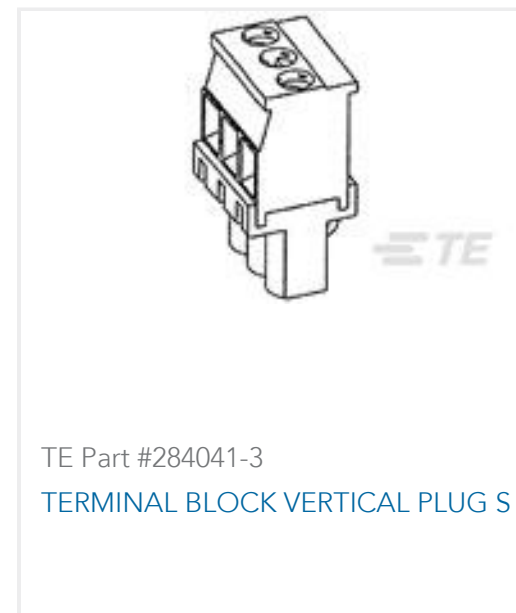
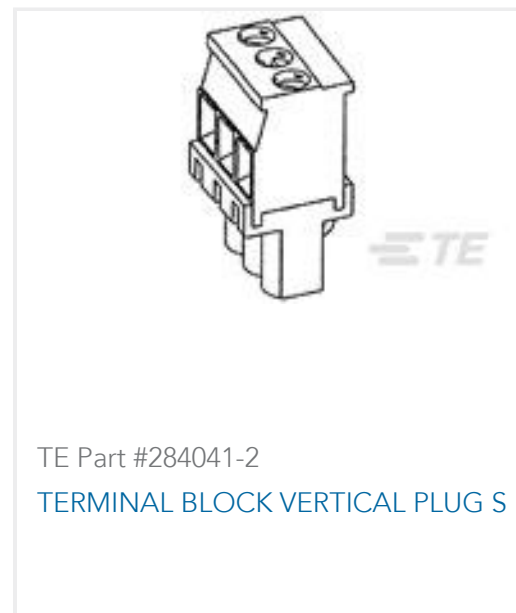
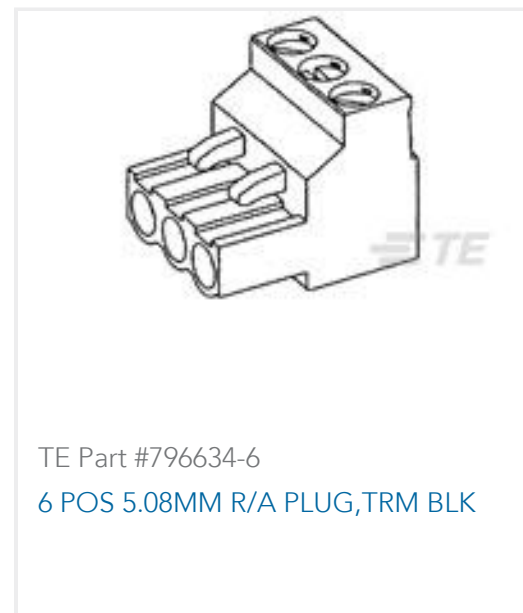

Documents

Product Drawings

[6POS 5.08MM CE VRT HDR,TRM BLK](#)

English

CAD Files

Customer View Model

[ENG_CVM_CVM_796636-6_B.2d_dxf.zip](#)

English

[3D PDF](#)

3D

Customer View Model

[ENG_CVM_CVM_796636-6_B.3d_igs.zip](#)

English

Customer View Model

[ENG_CVM_CVM_796636-6_B.3d_stp.zip](#)

English

By downloading the CAD file I accept and agree to the [Terms and Conditions](#) of use.

Datasheets & Catalog Pages

[Eurostyle Terminal Blocks Focus Product Stock List](#)

English

[BUCHANAN TERMINAL BLOCKS CATALOG - EUROSTYLE TERMINAL BLOCKS](#)

English

[BUCHANAN PCB TERMINAL BLOCKS](#)

English

[1-1773458-1_EURO_STYLE_TERMINAL_BLOCKS_QRG](#)

English



Product Specifications

Application Specification

English

Agency Approvals

UL

English