

1-327717-0 ✓ ACTIVE



PIDG

TE Internal #: 1-327717-0

Spade Tongue Terminal, 22 – 16 AWG, #4 / M2.5 Stud Size, 3.02 mm [.119 in] Stud Diameter, Closed Barrel, Straight, Tin, Partially Insulated, PIDG

[View on TE.com >](#)

Terminals & Splices > Spade Terminals > PIDG Spade Tongue Terminals

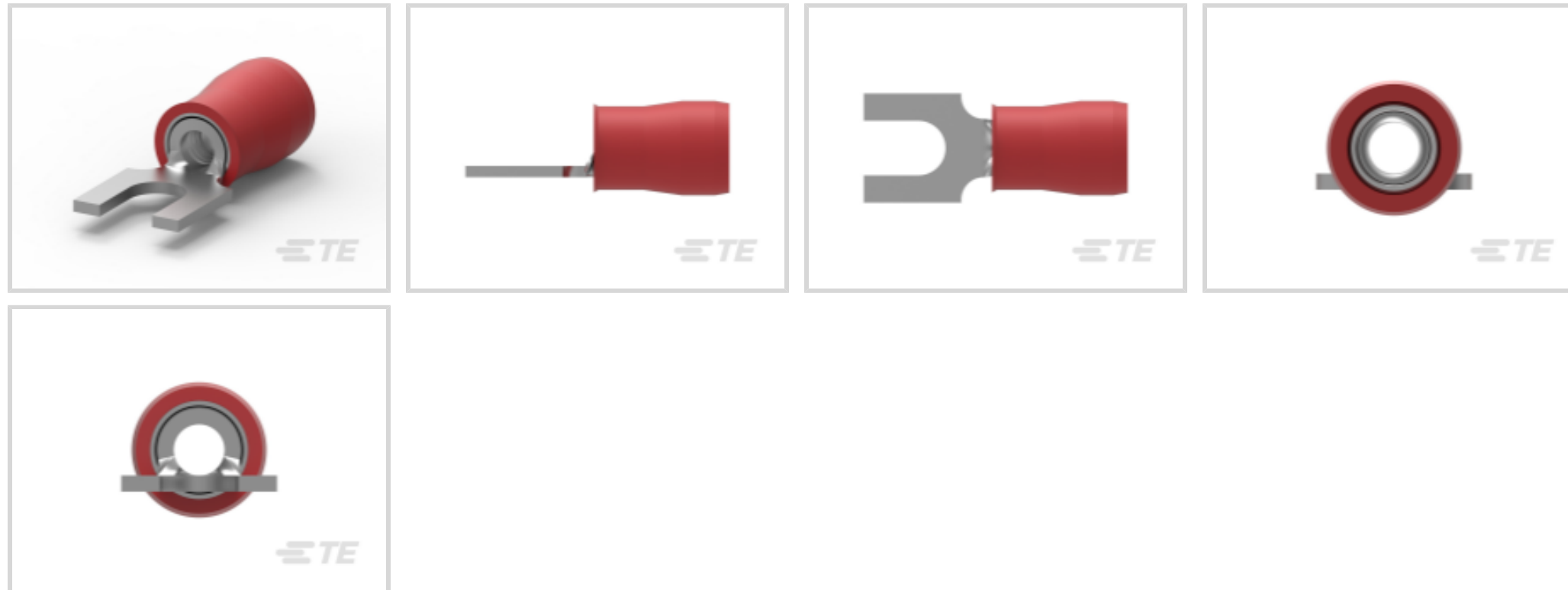

Spade Terminal Type: **Spade Tongue Terminal**

Wire Size: **509 – 3260 CMA**

Stud Size: **M2.5, #4**

[All PIDG Spade Tongue Terminals \(63\)](#)

Features

Contact Features

Spade Terminal Type	Spade Tongue Terminal
Barrel Type	Closed
Terminal Orientation	Straight
Terminal Plating Material	Tin

Dimensions

Wire Size	509 – 3260 CMA
Stud Diameter	3.02 mm [.119 in]
Tongue Thickness	.79 mm [.031 in]
Product Length	17.12 mm [.674 in]
Compatible Insulation Diameter (Max)	3.18 mm [.125 in]
Compatible Insulation Diameter Range	2.03 – 3.18 mm [.08 – .125 in]

Product Type Features

Stud Size	M2.5, #4
Sealable	No



Wire Insulation Support Retention Type	Insulation Support
--	--------------------

Usage Conditions

Insulation Option	Partially Insulated
Operating Temperature Range	105 °C[221 °F]

Operation/Application

Compatible With Wire Base Material	Copper
Compatible With Wire Plating Material	Tin

Packaging Features

Packaging Method	Loose Piece
Packaging Quantity	1000

Other

EU RoHS Compliance	Compliant
EU ELV Compliance	Compliant

Electrical Characteristics

Voltage Rating	300 V
----------------	-------

Body Features

Product Weight	.964 g
----------------	--------

Mechanical Attachment

Wire Insulation Support	With
-------------------------	------

Industry Standards

Government Qualified Terminal	No
-------------------------------	----

Product Compliance

[For compliance documentation, visit the product page on TE.com>](#)

EU RoHS Directive 2011/65/EU	Compliant
EU ELV Directive 2000/53/EC	Compliant
China RoHS 2 Directive MIIT Order No 32, 2016	No Restricted Materials Above Threshold
EU REACH Regulation (EC) No. 1907/2006	Current ECHA Candidate List: JUNE 2024 (241) Candidate List Declared Against: JUNE 2024 (241) Does not contain REACH SVHC
Halogen Content	Low Halogen - Br, Cl, F, I < 900 ppm per

homogenous material. Also BFR/CFR/PVC Free

Solder Process Capability

Not applicable for solder process capability

Product Compliance Disclaimer

This information is provided based on reasonable inquiry of our suppliers and represents our current actual knowledge based on the information they provided. This information is subject to change. The part numbers that TE has identified as EU RoHS compliant have a maximum concentration of 0.1% by weight in homogenous materials for lead, hexavalent chromium, mercury, PBB, PBDE, DBP, BBP, DEHP, DIBP, and 0.01% for cadmium, or qualify for an exemption to these limits as defined in the Annexes of Directive 2011/65/EU (RoHS2). Finished electrical and electronic equipment products will be CE marked as required by Directive 2011/65/EU. Components may not be CE marked. Additionally, the part numbers that TE has identified as EU ELV compliant have a maximum concentration of 0.1% by weight in homogenous materials for lead, hexavalent chromium, and mercury, and 0.01% for cadmium, or qualify for an exemption to these limits as defined in the Annexes of Directive 2000/53/EC (ELV). Regarding the REACH Regulation, the information TE provides on SVHC in articles for this part number is based on the latest European Chemicals Agency (ECHA) 'Guidance on requirements for substances in articles' posted at this URL: <https://echa.europa.eu/guidance-documents/guidance-on-reach>

Compatible Parts



REPRESENTATION ONLY

TE Part # 47386-4
DAHT PG PIDG 26-16 ASSY



TE Part # 59250
T-HEAD PIDG 26-14 ASSY



TE Part # 59824-1
TETRA-CRIMP PIDG PG FASTON 22-10 ASSY



REPRESENTATION ONLY

TE Part # 47386
DAHT PG PIDG 26-16 ASSY



TE Part # 58433-3
PRO CR ASSY, RBY IS9252



REPRESENTATION ONLY

TE Part # 525690
DAHT PG PIDG 20-18 ASSY



TE Part # 539691-2
ERGO DIE R.B.Y



TE Part # 58423-1
DIE, RBY IS9252



TE Part # 2063030-1
SDE DIESET, RBY, UL



TE Part # 47806-2
DIES PIDG 22-16 DIE SET



TE Part # 59300
T-HEAD PIDG PG 26-16 ASSY



TE Part # 169400
CERTI-LOK FRAME W/O DIES

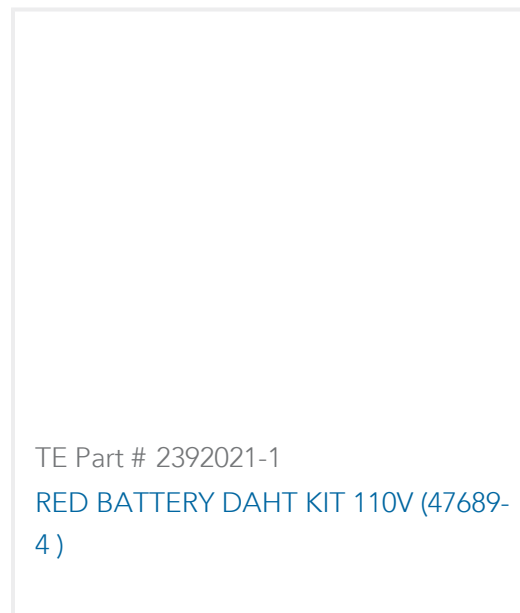
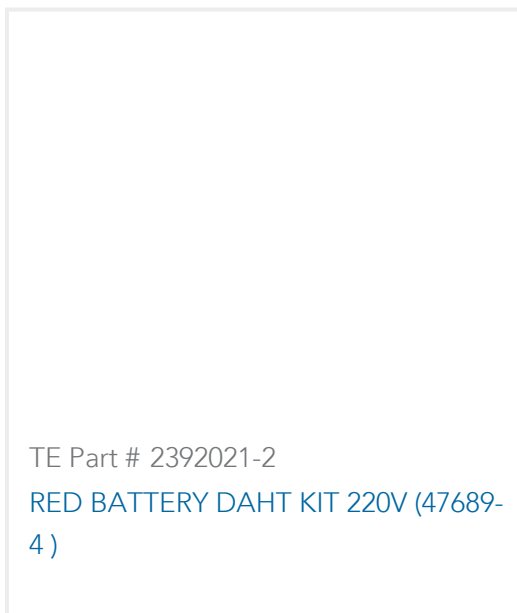

Also in the Series | PIDG

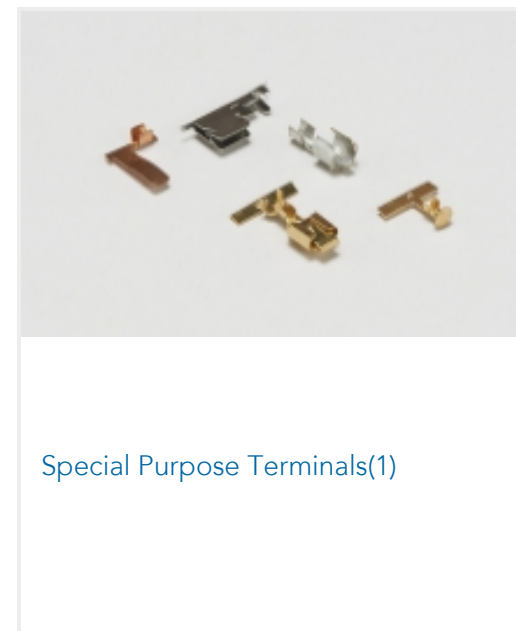
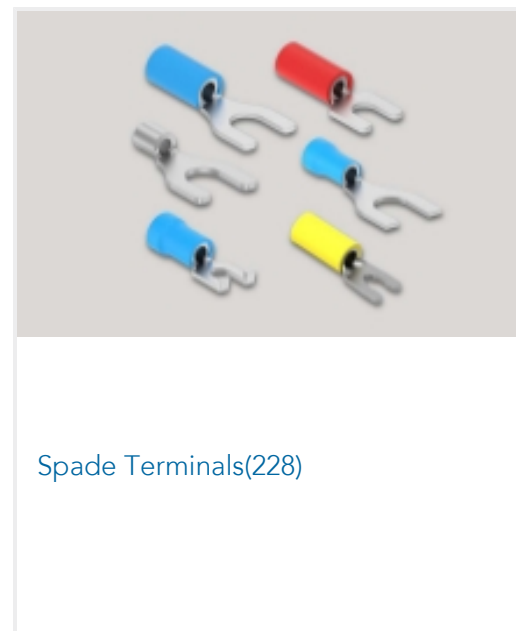
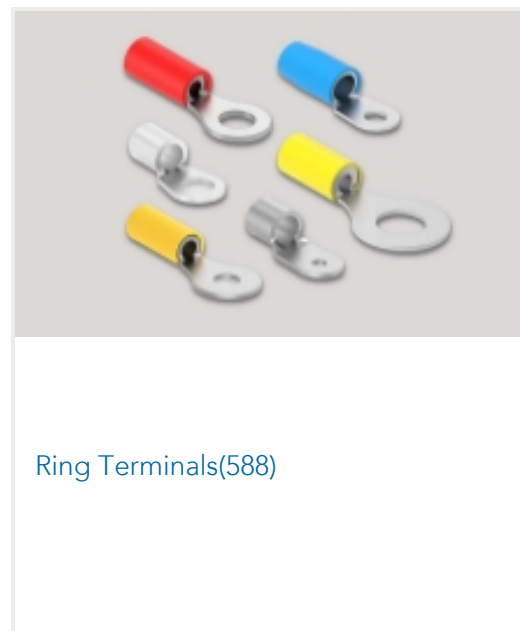
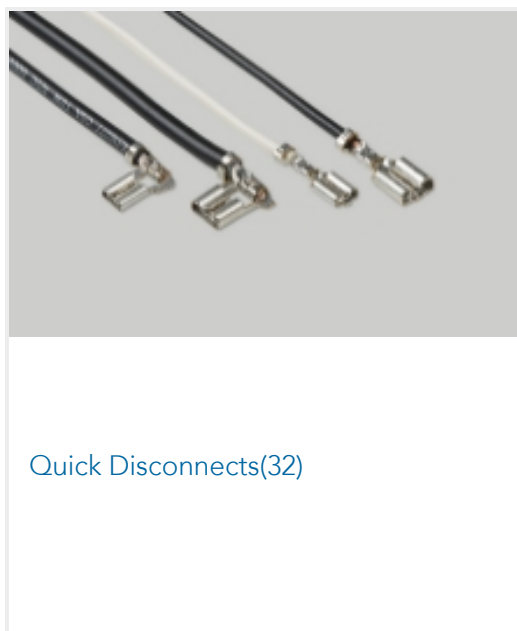
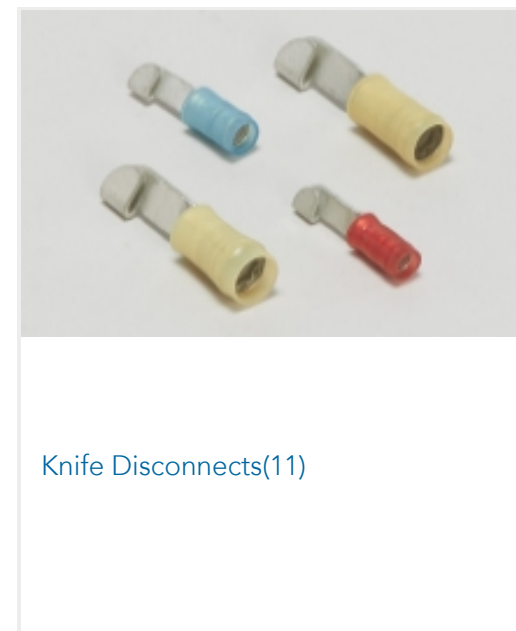
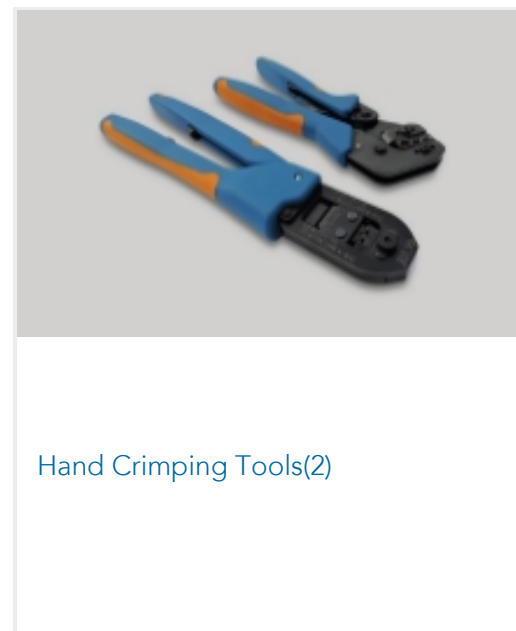
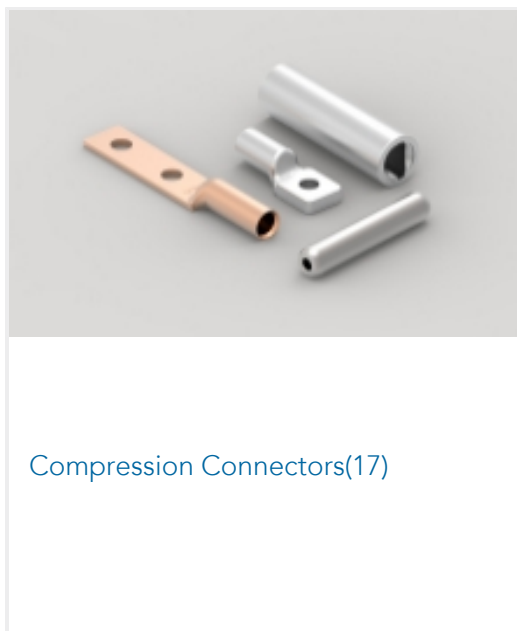

Customers Also Bought

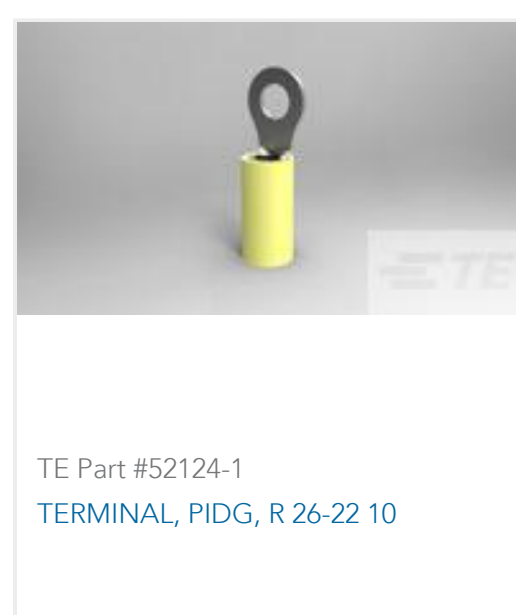

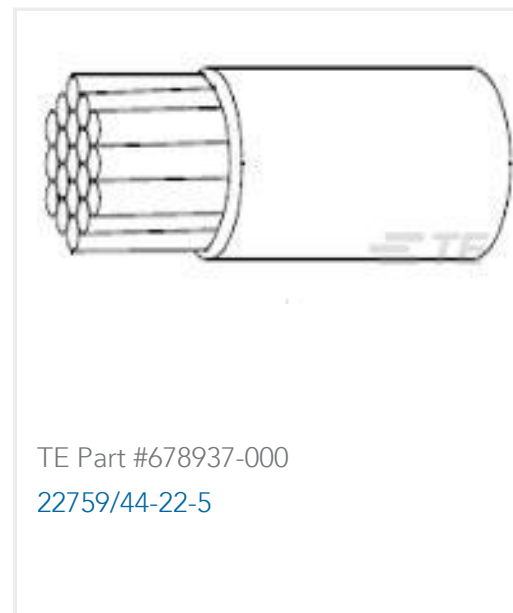
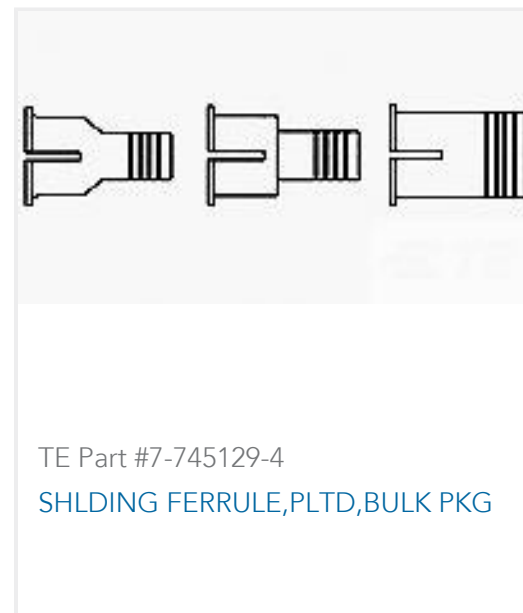

Documents

Product Drawings

[PIDG SPD 22-16 COMM 22-18MIL 4](#)

English

CAD Files

[3D PDF](#)

3D

Customer View Model

[ENG_CVM_CVM_1-327717-0_J.2d_dxf.zip](#)

English

Customer View Model

[ENG_CVM_CVM_1-327717-0_J.3d_igs.zip](#)

English

Customer View Model

[ENG_CVM_CVM_1-327717-0_J.3d_stp.zip](#)

English

By downloading the CAD file I accept and agree to the [Terms and Conditions](#) of use.

Datasheets & Catalog Pages

[PIDG Terminals and Splices Quick Reference Guide](#)

English

Instruction Sheets

[Instruction Sheet \(U.S.\)](#)

English

Agency Approvals

[UL Report](#)

English