



FASTIN-FASTON | FASTIN-FASTON 250

TE Internal #: 180351-2

Receptacle, 11 – 9 AWG Wire Size, 4 – 6.63 mm² Wire Size, Mating Tab Width 6.35 mm [.25 in], Straight, Brass, FASTIN-FASTON 250, Quick Disconnects

[View on TE.com >](#)

Terminals & Splices > Quick Disconnects

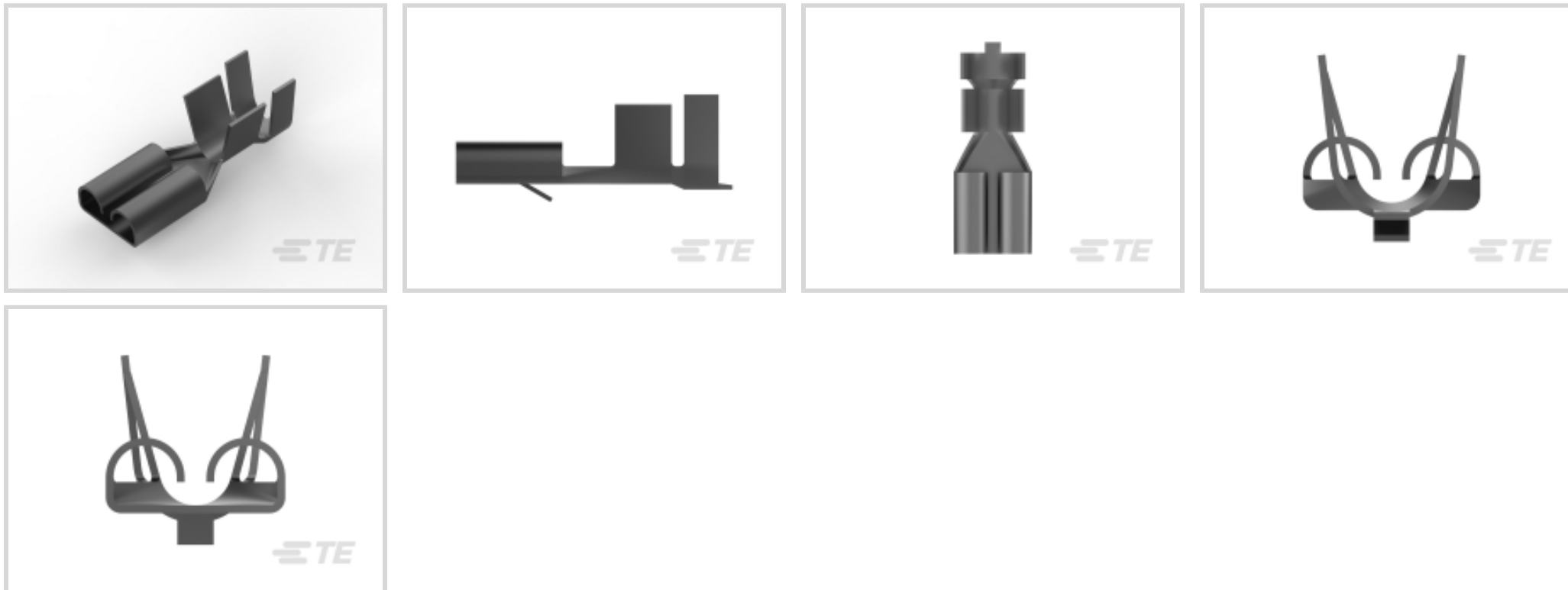

Quick Disconnect Terminal Type: **Receptacle**

Wire Size: **4 – 6.63 mm²**

Mating Tab Width: **6.35 mm [.25 in]**

Mating Tab Thickness: **.81 mm [.032 in]**

Features

Contact Features

Quick Disconnect Terminal Type	Receptacle
Mating Tab Width	6.35 mm [.25 in]
Mating Tab Thickness	.81 mm [.032 in]
Terminal Orientation	Straight
Contact Base Material	Brass
Terminal Plating Material	Pre-Tin
Crimp Type	F-Crimp
Barrel Type	Open

Dimensions

Wire Size	4 – 6.63 mm ²
Product Length	19 mm [.748 in]
Compatible Insulation Diameter Range	3.4 – 5.1 mm [.134 – .2 in]
Terminal Material Thickness	.33 mm [.013 in]

Packaging Features

Packaging Method	Strip/Reel
------------------	------------



Packaging Quantity	3000
--------------------	------

Product Type Features

Insertion Force	Normal
-----------------	--------

Usage Conditions

Insulation Option	Uninsulated
-------------------	-------------

Operating Temperature Range	-40 – 110 °C[-40 – 230 °F]
-----------------------------	----------------------------

Other

EU RoHS Compliance	Compliant
--------------------	-----------

EU ELV Compliance	Compliant
-------------------	-----------

Configuration Features

Compatible With Wire & Cable Type	Discrete Wire
-----------------------------------	---------------

Connection Capacity	Single
---------------------	--------

Electrical Characteristics

Voltage Rating	250 V
----------------	-------

Termination Features

Product Terminates To	Wire & Cable
-----------------------	--------------

Mechanical Attachment

Wire Insulation Support	With
-------------------------	------

Mating Retention Type	Locking Lance
-----------------------	---------------

Product Compliance

[For compliance documentation, visit the product page on TE.com>](#)

EU RoHS Directive 2011/65/EU	Compliant
------------------------------	-----------

EU ELV Directive 2000/53/EC	Compliant
-----------------------------	-----------

China RoHS 2 Directive MIIT Order No 32, 2016	No Restricted Materials Above Threshold
---	---

EU REACH Regulation (EC) No. 1907/2006	Current ECHA Candidate List: JUNE 2024 (241) Candidate List Declared Against: JUNE 2024 (241) Does not contain REACH SVHC
--	---

Halogen Content	Low Halogen - Br, Cl, F, I < 900 ppm per homogenous material. Also BFR/CFR/PVC Free
-----------------	---

Solder Process Capability	Not applicable for solder process capability
---------------------------	--



Product Compliance Disclaimer

This information is provided based on reasonable inquiry of our suppliers and represents our current actual knowledge based on the information they provided. This information is subject to change. The part numbers that TE has identified as EU RoHS compliant have a maximum concentration of 0.1% by weight in homogenous materials for lead, hexavalent chromium, mercury, PBB, PBDE, DBP, BBP, DEHP, DIBP, and 0.01% for cadmium, or qualify for an exemption to these limits as defined in the Annexes of Directive 2011/65/EU (RoHS2). Finished electrical and electronic equipment products will be CE marked as required by Directive 2011/65/EU. Components may not be CE marked. Additionally, the part numbers that TE has identified as EU ELV compliant have a maximum concentration of 0.1% by weight in homogenous materials for lead, hexavalent chromium, and mercury, and 0.01% for cadmium, or qualify for an exemption to these limits as defined in the Annexes of Directive 2000/53/EC (ELV). Regarding the REACH Regulation, the information TE provides on SVHC in articles for this part number is based on the latest European Chemicals Agency (ECHA) 'Guidance on requirements for substances in articles' posted at this URL: <https://echa.europa.eu/guidance-documents/guidance-on-reach>

Compatible Parts



Also in the Series | FASTIN-FASTON 250

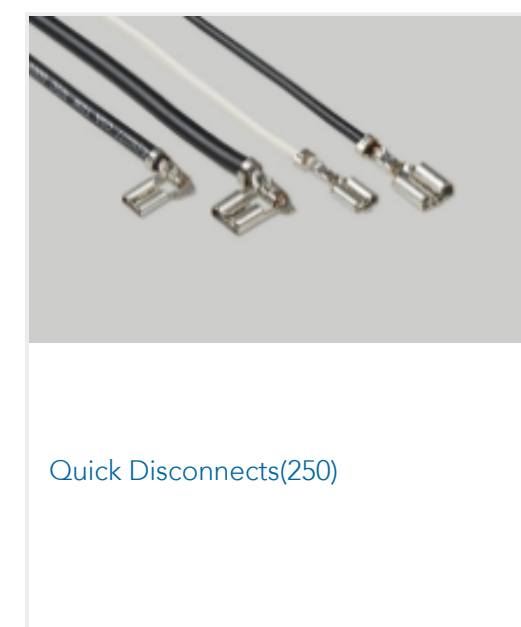
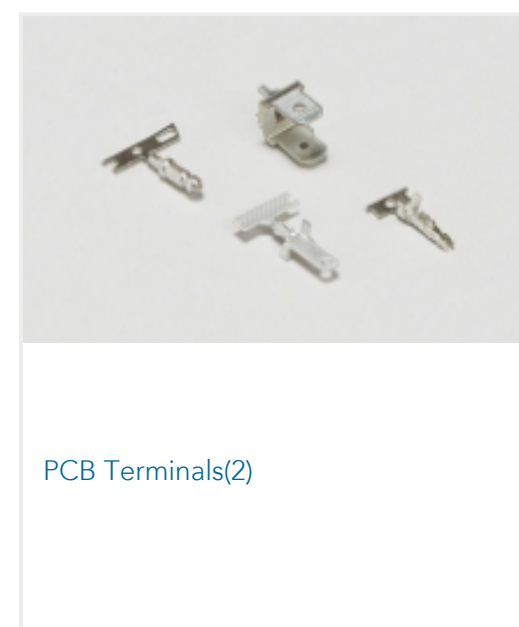
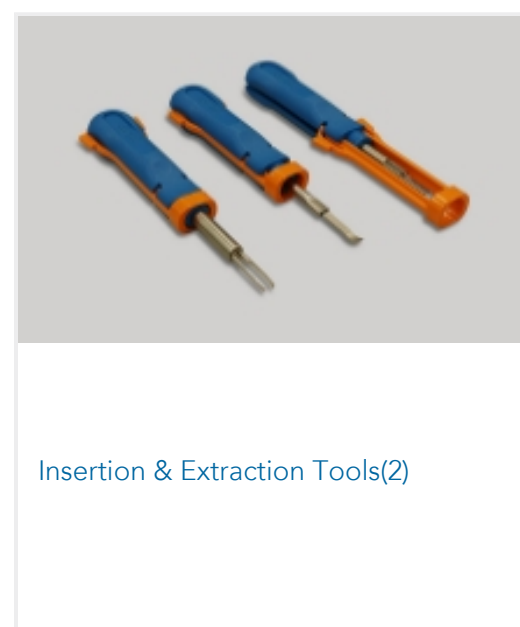
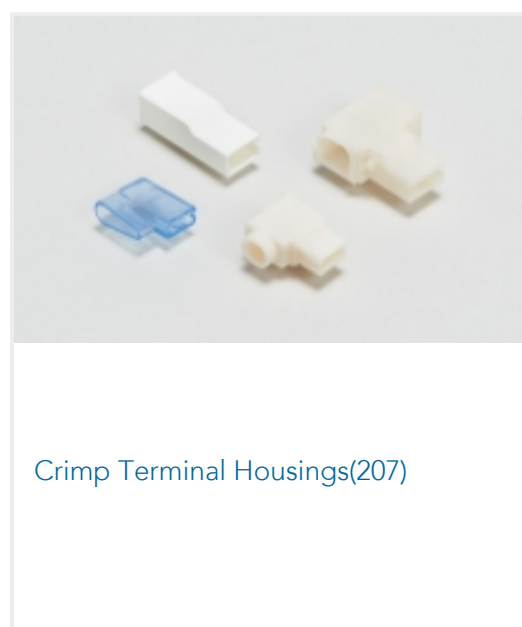

Customers Also Bought



TE Part #5-1971776-3
High Temperature Plug — POWER
TRIPLE LOCK



TE Part #5-1971772-7
PTL 1X5 CAP PANEL MT HITEMP KEY
A LGR



TE Part #368136-6
MULTILOCK, CONNECTOR HOUSING

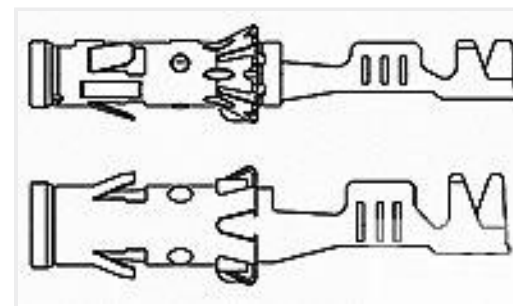

TE Part #962954-2
4MM BUCHS-KONTAKT



TE Part #1241608-1
MQS1,5 Sn rec CB unseal. 0,75-1,5

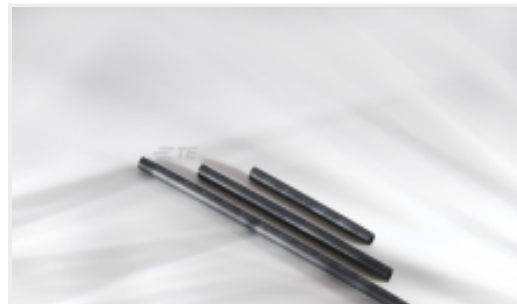

TE Part #537637P036
SCT-NO.3-E3-0-75MM

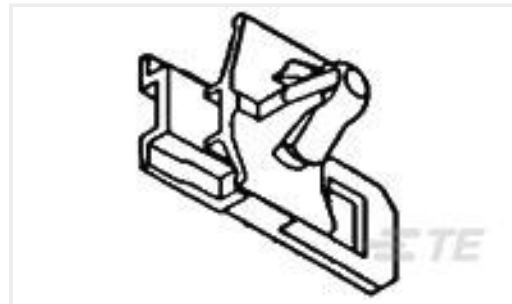

TE Part #345485-1
BODY CLIP HOUSING DUAL

Documents

Product Drawings

[FF 250 REC 4-6MM2 PTBR](#)

English

CAD Files

[3D PDF](#)

3D

Customer View Model

[ENG_CVM_CVM_180351-2_AD_c-180351-2-ad.2d_dxf.zip](#)

English

Customer View Model

[ENG_CVM_CVM_180351-2_AD_c-180351-2-ad.3d_igs.zip](#)

English

Customer View Model

[ENG_CVM_CVM_180351-2_AD_c-180351-2-ad.3d_stp.zip](#)

English

By downloading the CAD file I accept and agree to the [Terms and Conditions](#) of use.

Datasheets & Catalog Pages

[FASTIN_FASTON_Product_Line](#)

English

[1654742_HOUSEHOLD_APPLIANCES_RAST5](#)

English

Product Specifications

[Application Specification](#)

English

180351-2

Receptacle, 11 – 9 AWG Wire Size, 4 – 6.63 mm² Wire Size, Mating Tab Width 6.35 mm [.25 in], Straight, Brass, FASTIN-FASTON 250, Quick Disconnects



Application Specification

English