

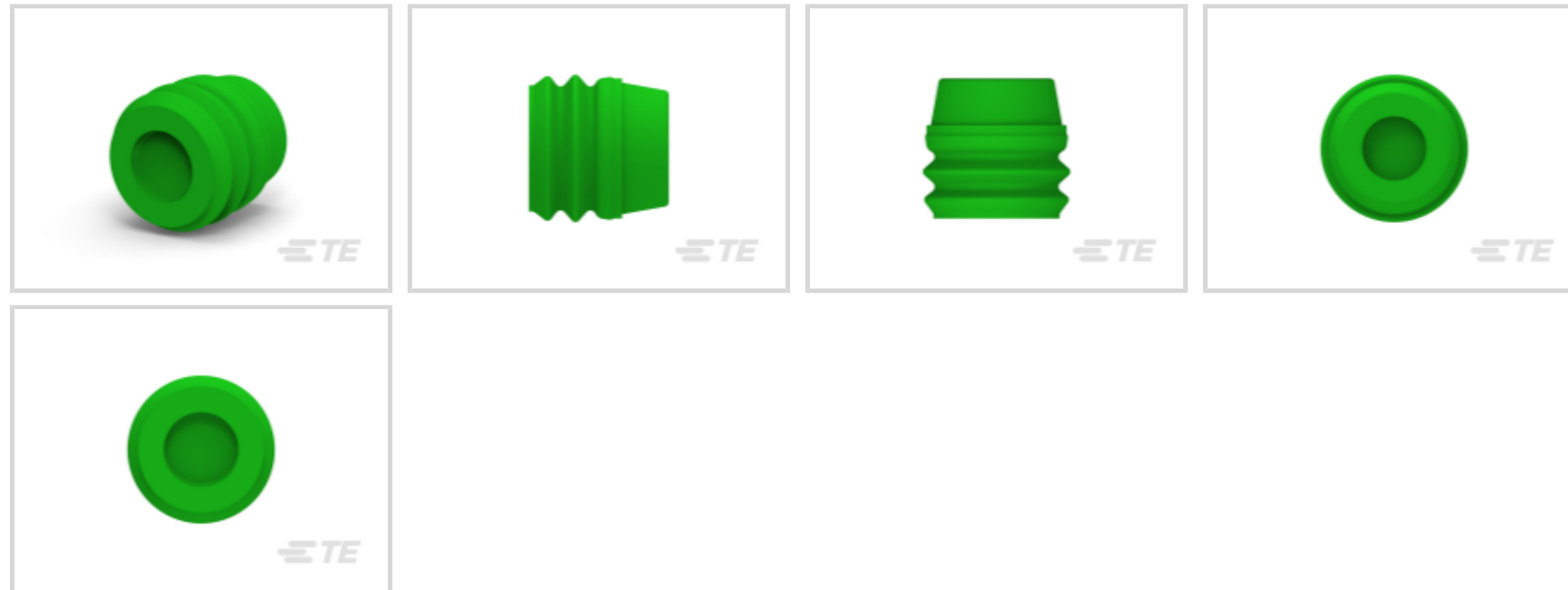

Connectors > Connector Accessories > Connector Seals & Cavity Plugs



Connector Seal & Plug Type: **Cable Seal**

Primary Product Material: **VMQ**

Primary Product Color: **Green**

Shore A Hardness: **40**

Operating Temperature (Max): **125 °C [257 °F]**

Features

Product Type Features

Connector Seal & Plug Type	Cable Seal
----------------------------	------------

Body Features

Primary Product Material	VMQ
Primary Product Color	Green

Other

Shore A Hardness	40
Contains Lubricant	Yes
EU RoHS Compliance	Compliant
EU ELV Compliance	Compliant

Usage Conditions

Operating Temperature (Max)	125 °C[257 °F]
Operating Temperature Range	-55 – 125 °C[-67 – 257 °F]

Configuration Features

Number of Positions	1
---------------------	---



Packaging Features

Packaging Method	Box
Packaging Quantity	2500

Product Compliance

[For compliance documentation, visit the product page on TE.com>](#)

EU RoHS Directive 2011/65/EU	Compliant
EU ELV Directive 2000/53/EC	Compliant
China RoHS 2 Directive MIIT Order No 32, 2016	No Restricted Materials Above Threshold
EU REACH Regulation (EC) No. 1907/2006	<p>Current ECHA Candidate List: JUNE 2024 (241) Candidate List Declared Against: JUNE 2024 (241) SVHC > Threshold: Octamethylcyclotetrasiloxane (D4) (.5% in Component Part) Dodecamethylcyclohexasiloxane (D6) (.5% in Component Part) Decamethylcyclopentasiloxane (D5) (.5% in Component Part)</p> <p>Article Safe Usage Statements: Wash thoroughly after handling. Recycle if possible and dispose of the article by following all applicable governmental regulations relevant to your geographic location.</p>
Halogen Content	Low Halogen - Br, Cl, F, I < 900 ppm per homogenous material. Also BFR/CFR/PVC Free
Solder Process Capability	Not reviewed for solder process capability

Product Compliance Disclaimer

This information is provided based on reasonable inquiry of our suppliers and represents our current actual knowledge based on the information they provided. This information is subject to change. The part numbers that TE has identified as EU RoHS compliant have a maximum concentration of 0.1% by weight in homogenous materials for lead, hexavalent chromium, mercury, PBB, PBDE, DBP, BBP, DEHP, DIBP, and 0.01% for cadmium, or qualify for an exemption to these limits as defined in the Annexes of Directive 2011/65/EU (RoHS2). Finished electrical and electronic equipment products will be CE marked as required by Directive 2011/65/EU. Components may not be CE marked. Additionally, the part numbers that TE has identified as EU ELV compliant have a maximum concentration of 0.1% by weight in homogenous materials for lead, hexavalent chromium, and mercury, and 0.01% for cadmium, or qualify for an exemption to these limits as defined in the Annexes of Directive 2000/53/EC (ELV). Regarding the REACH Regulation, the information TE provides on SVHC in articles for this part number is based on the latest European Chemicals Agency (ECHA) 'Guidance on requirements for substances in articles' posted at this URL: <https://echa.europa.eu/guidance-documents/guidance-on-reach>

Compatible Parts



Also in the Series | **DEUTSCH DT**

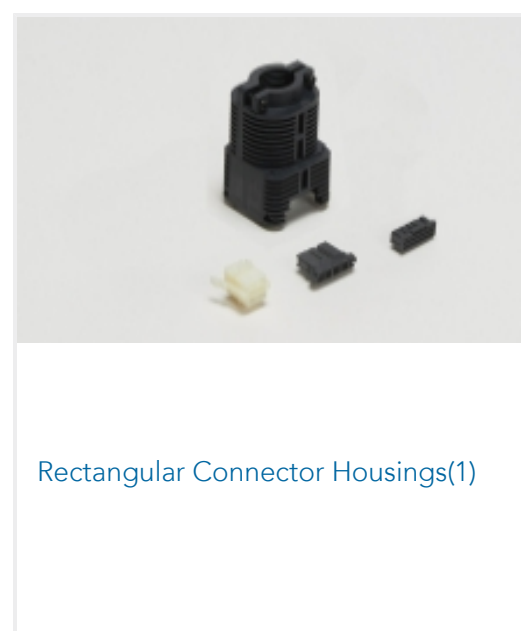
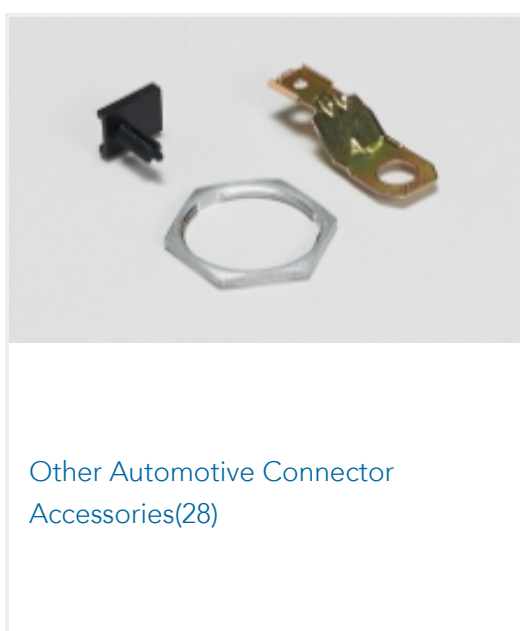
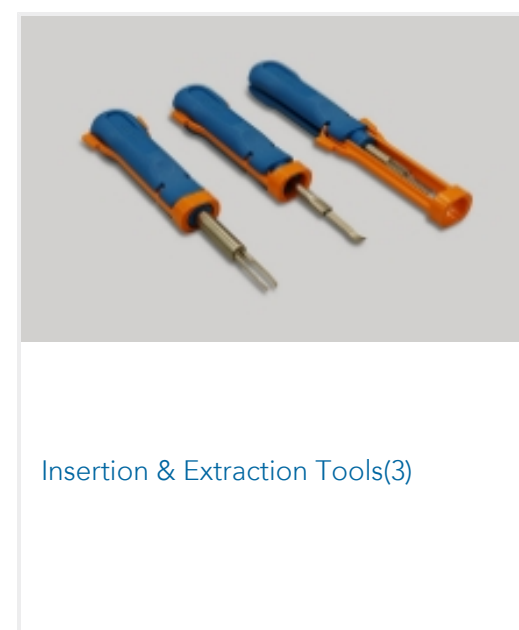
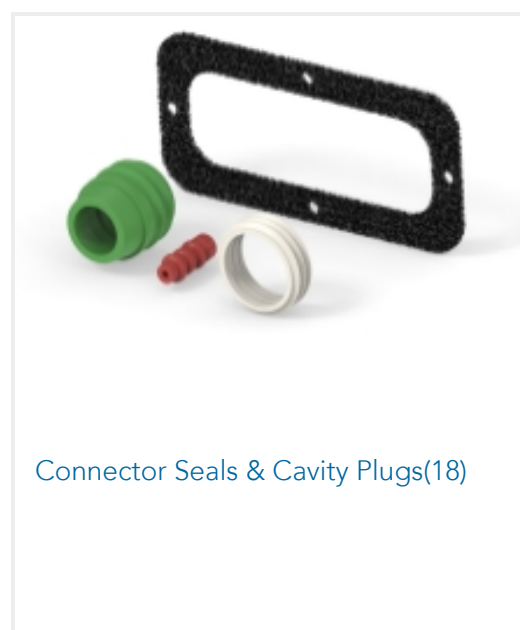
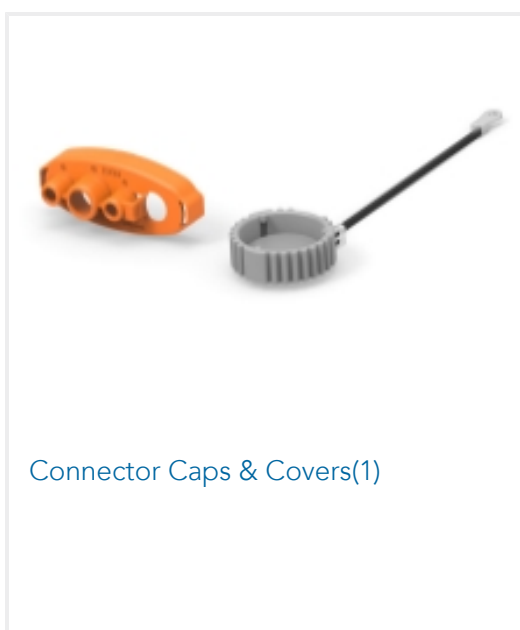
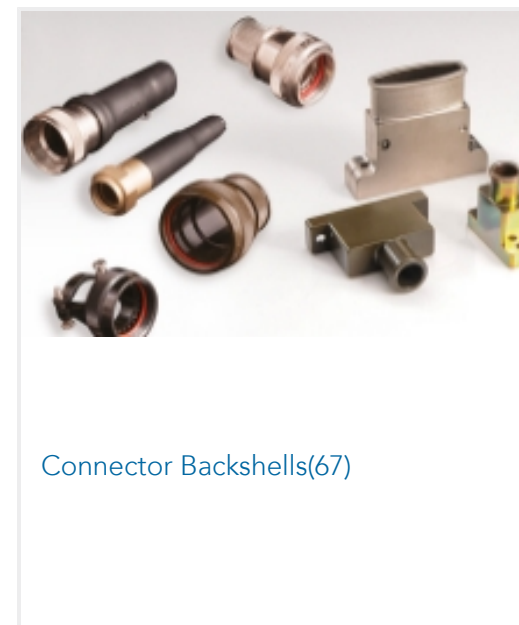
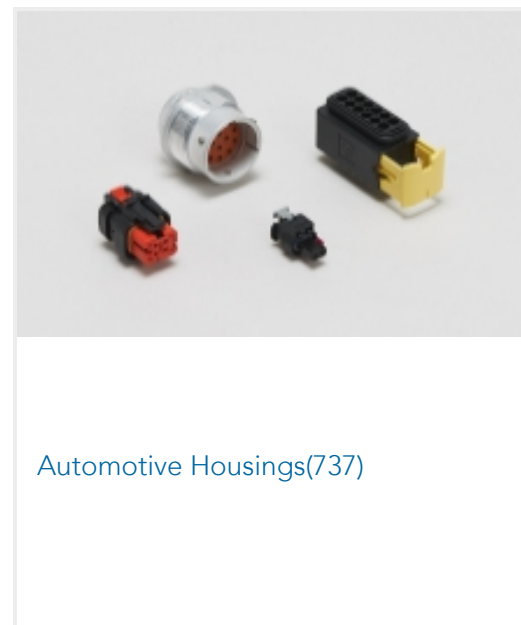
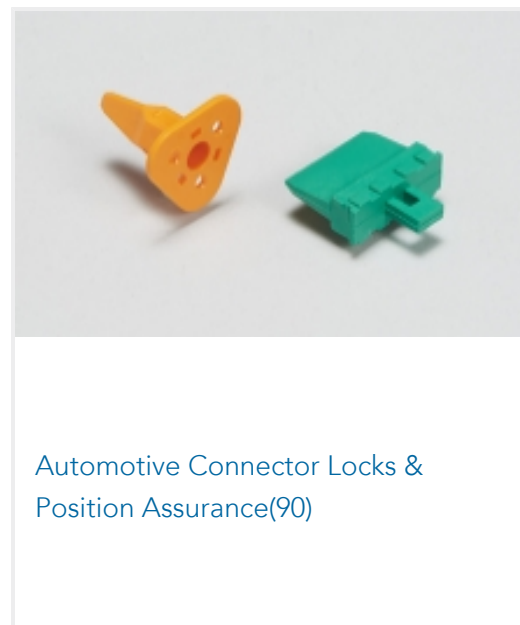

Also in the Series | **DEUTSCH DTSK**

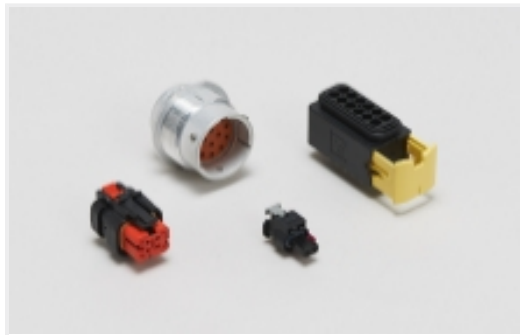

Automotive Housings(6)

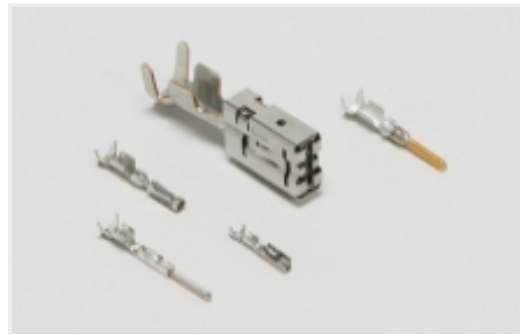

Automotive Terminals(6)



Connector Seals & Cavity Plugs(3)

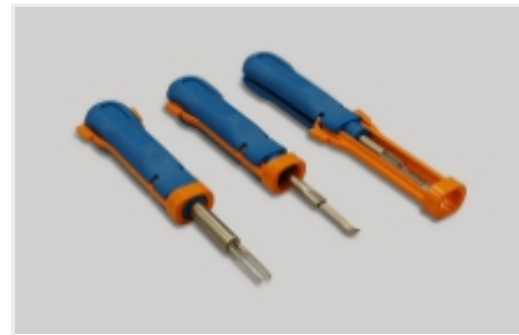

Insertion & Extraction Tools(1)

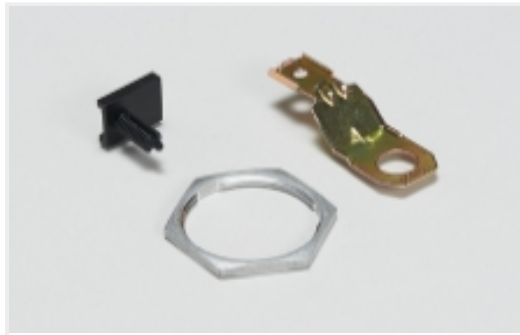

Other Automotive Connector Accessories(1)

Customers Also Bought



TE Part #2112166-1
SLIDE, FOR 21 POS.



TE Part #HDP26-18-14SN-L017
PLG, 14P, BLK, N, RNG, 16, S

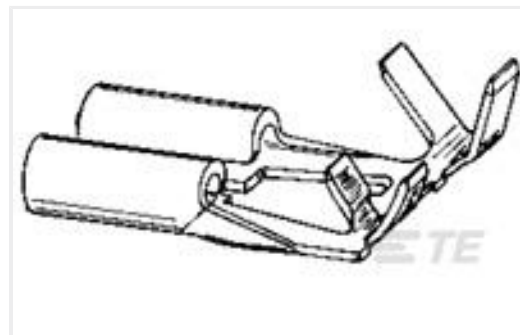

TE Part #180373-2
FF 312 REC 1-2.5MM2 TPBR



TE Part #163301-8
MATENLOK PIN



TE Part #DRC26-50S03
PLG, 50P, BLK, N, 03



TE Part #5928983001
FTR16-120-0



TE Part #9166473001
TR16-35-0



TE Part #2-2365266-1
2POS, 21MM, CABLE SEAL COLLET, ASSY



TE Part #DTSK04-1-08PA
RECEPTACLE, INLINE, KEY A



TE Part #2-2344533-1
SHIELD CRIMP FERRULE

Documents



Product Drawings

[WS-35-001, SEAL, GRN, 10.59-11.59, DTSK](#)

English

CAD Files

[3D PDF](#)

3D

Customer View Model

[ENG_CVM_CVM_2289243-1_A.2d_dxf.zip](#)

English

Customer View Model

[ENG_CVM_CVM_2289243-1_A.3d_igs.zip](#)

English

Customer View Model

[ENG_CVM_CVM_2289243-1_A.3d_stp.zip](#)

English

By downloading the CAD file I accept and agree to the [Terms and Conditions](#) of use.

Datasheets & Catalog Pages

[DEUTSCH DTSK Connectors Series Brief](#)

English

[DEUTSCH DTSK Components Infographic](#)

English

[ICT Terminals and Connectors Catalogue](#)

English

Product Specifications

[Application Specification](#)

English