



RAST | RAST 5 IDC Connectors

TE Internal #: 2-2232043-2

PCB Mount Header, Vertical, Wire-to-Board, 2 Position, 5 mm [.197 in] Centerline, Fully Shrouded, Tin, Through Hole - Solder, RAST 5 IDC Connectors

[View on TE.com >](#)

Connectors > PCB Connectors > PCB Headers & Receptacles



EU RoHS Compliance: **Compliant**

EU ELV Compliance: **Compliant**

PCB Connector Assembly Type: **PCB Mount Header**

PCB Mount Orientation: **Vertical**

Connector System: **Wire-to-Board**

Features

Other

EU RoHS Compliance	Compliant
EU ELV Compliance	Compliant

Product Type Features

PCB Connector Assembly Type	PCB Mount Header
Connector System	Wire-to-Board
Header Type	Fully Shrouded
Sealable	No
Connector & Contact Terminates To	Printed Circuit Board

Configuration Features

Number of Columns	2
Keying & Polarized Position Locations	1C,2D, 1C, 2D
PCB Mount Orientation	Vertical
Number of Positions	2
Number of Rows	1



Electrical Characteristics

Operating Voltage	250 VAC
-------------------	---------

Body Features

Primary Product Color	Natural
-----------------------	---------

Contact Features

Contact Underplating Material	Nickel
Contact Underplating Material Thickness	1.27 μ m[50 μ in]
PCB Contact Termination Area Plating Material Finish	Matte
Contact Mating Area Plating Material Thickness	2 μ m[78.74 μ in]
Mating Tab Width	6.3 mm[.248 in]
PCB Contact Termination Area Plating Material Thickness	2 μ m[78.74 μ in]
Contact Shape & Form	Rectangular
Contact Layout	Inline
Contact Mating Area Length	8.5 mm[.33 in]
Contact Base Material	Copper Alloy
Mating Tab Thickness	.8 mm[.032 in]
PCB Contact Termination Area Plating Material	Tin
Contact Mating Area Plating Material Finish	Matte
Contact Mating Area Plating Material	Tin
Contact Type	Tab
Contact Current Rating (Max)	16 A

Termination Features

Termination Post & Tail Length	3.5 mm[.138 in]
Square Termination Post & Tail Dimension	.8 mm[.032 in]
Termination Method to PCB	Through Hole - Solder

Mechanical Attachment

Mating Retention Type	Latch
Mating Retention	With
Mating Alignment Type	Keyed, Polarization
PCB Mount Alignment Type	Polarizing Pegs
PCB Mount Retention	Without
PCB Mount Alignment	With



Connector Mounting Type	Board Mount
-------------------------	-------------

Mating Alignment	With
------------------	------

Housing Features

Housing Material	Nylon
------------------	-------

Centerline (Pitch)	5 mm [.197 in]
--------------------	----------------

Dimensions

Connector Width	14.9 mm [.58 in]
-----------------	------------------

PCB Thickness (Recommended)	1.5 mm [.06 in]
-----------------------------	-----------------

Connector Height	12.8 mm [.503 in]
------------------	-------------------

Connector Length	12.3 mm [.48 in]
------------------	------------------

Usage Conditions

Operating Temperature Range	-40 – 120 °C [-40 – 248 °F]
-----------------------------	-----------------------------

Operation/Application

Circuit Application	Power
---------------------	-------

Industry Standards

Compatible With Agency/Standards Products	UL, VDE
---	---------

Compatible With Approved Standards Products	UL E28476
---	-----------

UL Flammability Rating	UL 94V-0
------------------------	----------

Packaging Features

Packaging Quantity	153
--------------------	-----

Packaging Method	Loose Piece
------------------	-------------

Product Compliance

For compliance documentation, visit the product page on [TE.com](https://www.te.com)>

EU RoHS Directive 2011/65/EU	Compliant
------------------------------	-----------

EU ELV Directive 2000/53/EC	Compliant
-----------------------------	-----------

China RoHS 2 Directive MIIT Order No 32, 2016	No Restricted Materials Above Threshold
---	---

EU REACH Regulation (EC) No. 1907/2006	Current ECHA Candidate List: JUNE 2024 (241) Candidate List Declared Against: JUNE 2024 (241) Does not contain REACH SVHC
--	---

Halogen Content	Not Low Halogen - contains Br or Cl > 900 ppm.
-----------------	--



Solder Process Capability

Not reviewed for solder process capability

Product Compliance Disclaimer

This information is provided based on reasonable inquiry of our suppliers and represents our current actual knowledge based on the information they provided. This information is subject to change. The part numbers that TE has identified as EU RoHS compliant have a maximum concentration of 0.1% by weight in homogenous materials for lead, hexavalent chromium, mercury, PBB, PBDE, DBP, BBP, DEHP, DIBP, and 0.01% for cadmium, or qualify for an exemption to these limits as defined in the Annexes of Directive 2011/65/EU (RoHS2). Finished electrical and electronic equipment products will be CE marked as required by Directive 2011/65/EU. Components may not be CE marked. Additionally, the part numbers that TE has identified as EU ELV compliant have a maximum concentration of 0.1% by weight in homogenous materials for lead, hexavalent chromium, and mercury, and 0.01% for cadmium, or qualify for an exemption to these limits as defined in the Annexes of Directive 2000/53/EC (ELV). Regarding the REACH Regulation, the information TE provides on SVHC in articles for this part number is based on the latest European Chemicals Agency (ECHA) 'Guidance on requirements for substances in articles' posted at this URL: <https://echa.europa.eu/guidance-documents/guidance-on-reach>

Compatible Parts



TE Part # 2232043-2
2P, RAST 5 Tab Header, THV

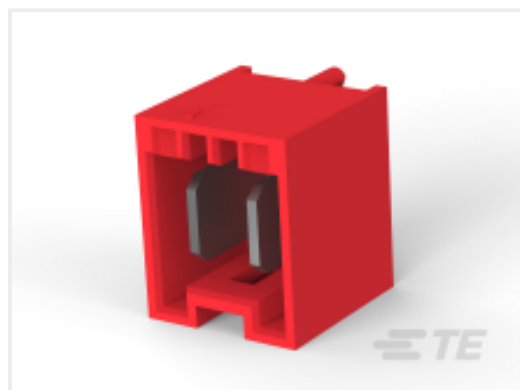

TE Part # 1971946-2
2P, RAST 5 Tab Header, THV, RED

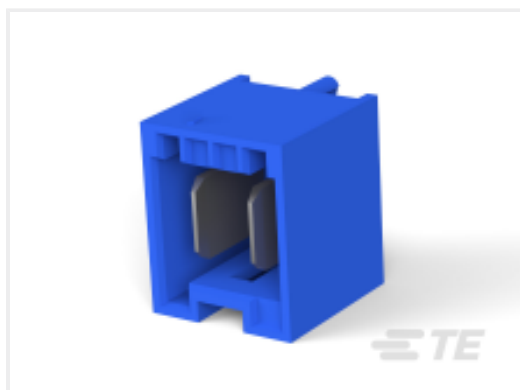

TE Part # 1-1971954-2
2P, RAST 5 Tab Header, THV



TE Part # 1-2232000-2
2P, RAST 5 Tab Header, THV,black, Tin



TE Part # 1-2232043-2
2P, RAST 5 Tab Header, THV



TE Part # 1-2232045-2
2P, RAST 5 Tab Header, THV



TE Part # 1-2292457-2
2P, RAST 5 HEADER, PL, SHROUDED



TE Part # 1971954-2
2P, RAST 5 Tab Header, THV



TE Part # 2-2232045-2
2P, RAST 5 Tab Header, THV



TE Part # 2232000-2
2P, RAST 5 Tab Header, THV,black, tin



TE Part # 2232045-2
2P, RAST 5 Tab Header, THV



TE Part # 3-2232045-2
2P, RAST 5 Tab Header, THV



Also in the Series | RAST 5 IDC Connectors

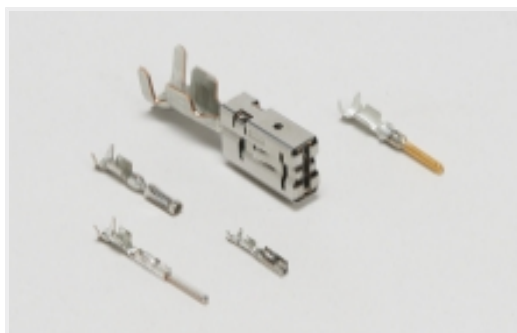

Automotive Terminals(8)



Connector Contacts(14)

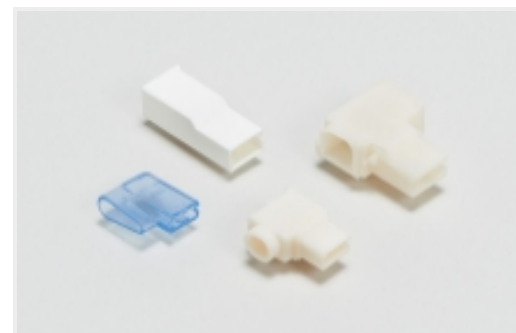

Crimp Terminal Housings(39)



Insertion & Extraction Tools(1)

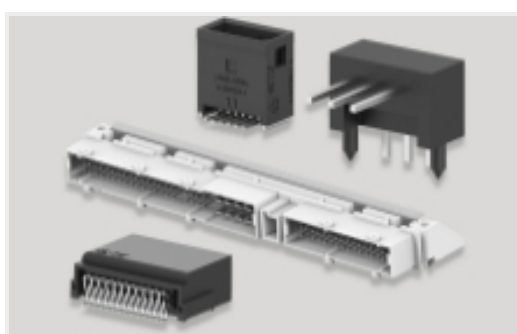

PCB Headers & Receptacles(417)



Rectangular Connector Housings(1)

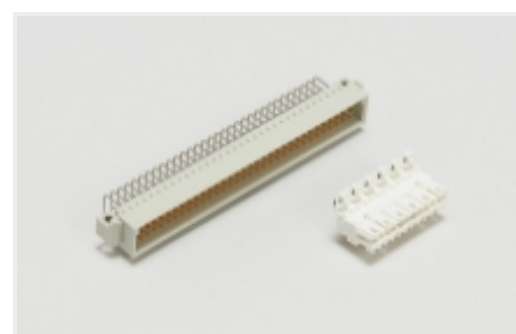

Standard Edge Connectors(32)



Standard Rectangular Connectors(63)

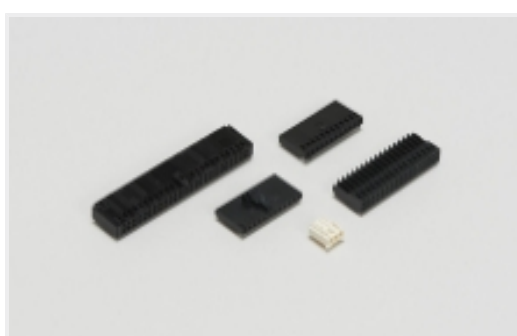

Wire-to-Board Connector Assemblies & Housings(203)

Customers Also Bought

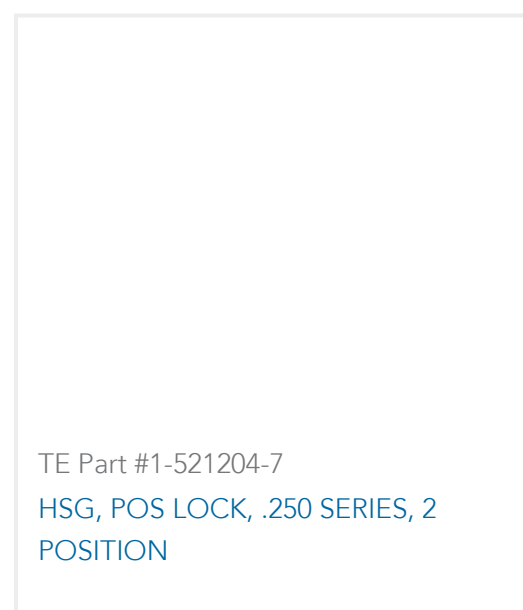

Documents

Product Drawings

[2P, RAST 5 Tab Header, THV](#)

English

CAD Files

[3D PDF](#)

3D

Customer View Model

[ENG_CVM_CVM_2-2232043-2_A_c-2-2232043-2-a.2d_dxf.zip](#)

English

Customer View Model

[ENG_CVM_CVM_2-2232043-2_A_c-2-2232043-2-a.3d_igs.zip](#)

English

Customer View Model

[ENG_CVM_CVM_2-2232043-2_A_c-2-2232043-2-a.3d_stp.zip](#)

English

By downloading the CAD file I accept and agree to the [Terms and Conditions](#) of use.

Datasheets & Catalog Pages



[RAST Connector System Catalog](#)

English

[Product Specifications](#)

[Product Specification](#)

English

[Agency Approvals](#)

[VDE Certificate](#)

English

[VDE Certificate](#)

English