

103167-5 ✓ ACTIVE

AMPMODU | AMPMODU Headers

TE Internal #: 103167-5

PCB Mount Header, Right Angle, Wire-to-Board, 16 Position, 2.54 mm [.1 in] Centerline, Fully Shrouded, Gold, Through Hole - Solder, AMPMODU Headers

[View on TE.com >](#)



Connectors > PCB Connectors > PCB Headers & Receptacles

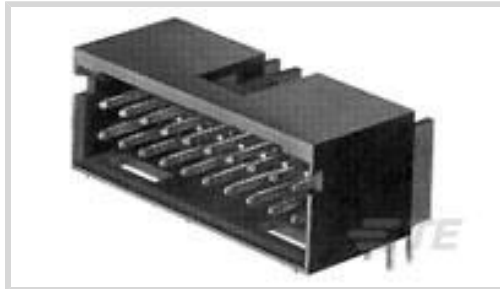

EU RoHS Compliance: **Not Compliant**

EU ELV Compliance: **Not Compliant**

PCB Connector Assembly Type: **PCB Mount Header**

PCB Mount Orientation: **Right Angle**

Connector System: **Wire-to-Board**

Features

Other

EU RoHS Compliance	Not Compliant
EU ELV Compliance	Not Compliant

Product Type Features

PCB Connector Assembly Type	PCB Mount Header
Connector System	Wire-to-Board
Header Type	Fully Shrouded
Connector & Contact Terminates To	Printed Circuit Board

Configuration Features

Connector Contact Load Condition	Fully Loaded
PCB Mount Orientation	Right Angle
Number of Positions	16
Number of Rows	2

Electrical Characteristics

Insulation Resistance	5000 M Ω
Dielectric Withstanding Voltage (Max)	750 Vrms

Body Features

Connector Profile	Standard
Primary Product Color	Black



Contact Features

Contact Underplating Material	Nickel
Contact Mating Area Plating Material Thickness	.762 μm [30 μin]
Mating Square Post Dimension	.64 mm[.025 in]
PCB Contact Termination Area Plating Material Thickness	2.54 – 5.08 μm [100 – 200 μin]
Contact Shape & Form	Square
Contact Base Material	Phosphor Bronze
PCB Contact Termination Area Plating Material	Tin-Lead
Contact Mating Area Plating Material	Gold
Contact Type	Pin
Contact Current Rating (Max)	3 A

Termination Features

Termination Post & Tail Length	3.43 mm[.135 in]
Square Termination Post & Tail Dimension	.64 mm[.025 in]
Termination Method to PCB	Through Hole - Solder

Mechanical Attachment

Mating Retention Type	Detent Window
Mating Retention	With
Mating Alignment Type	Polarization
PCB Mount Retention	Without
PCB Mount Alignment	Without
Connector Mounting Type	Board Mount
Mating Alignment	With

Housing Features

Housing Material	Thermoplastic
Centerline (Pitch)	2.54 mm[.1 in]

Dimensions

Row-to-Row Spacing	2.54 mm[.1 in]
PCB Thickness (Recommended)	1.4 mm[.055 in]

Usage Conditions

Housing Temperature Rating	Standard
Operating Temperature Range	-65 – 105 $^{\circ}\text{C}$ [-85 – 221 $^{\circ}\text{F}$]



Operation/Application

Solder Process Feature	Board Standoff
Circuit Application	Signal

Industry Standards

Compatible With Agency/Standards Products	CSA
Compatible With Approved Standards Products	UL E28476, CSA LR7189
UL Flammability Rating	UL 94V-0

Packaging Features

Packaging Quantity	176
Packaging Method	Tray

Product Compliance

[For compliance documentation, visit the product page on TE.com>](#)

EU RoHS Directive 2011/65/EU	Not Compliant
EU ELV Directive 2000/53/EC	Not Compliant
China RoHS 2 Directive MIIT Order No 32, 2016	Restricted Materials Above Threshold
EU REACH Regulation (EC) No. 1907/2006	Current ECHA Candidate List: JUNE 2024 (241) Candidate List Declared Against: JUNE 2024 (241) SVHC > Threshold: Pb (40% in Component Part) Article Safe Usage Statements: Do not eat, drink or smoke when using this product. Wash thoroughly after handling. Recycle if possible and dispose of the article by following all applicable governmental regulations relevant to your geographic location.
Halogen Content	BFR/CFR/PVC Free, but Br/Cl >900 ppm in other sources.
Solder Process Capability	Wave solder capable to 240°C

Product Compliance Disclaimer

This information is provided based on reasonable inquiry of our suppliers and represents our current actual knowledge based on the information they provided. This information is subject to change. The part numbers that TE has identified as EU RoHS compliant have a maximum concentration of 0.1% by weight in homogenous materials for lead, hexavalent chromium, mercury, PBB, PBDE, DBP, BBP, DEHP, DIBP, and 0.01% for cadmium, or qualify for an exemption to these limits as defined in the Annexes of Directive 2011/65/EU (RoHS2). Finished electrical and electronic equipment products will be CE marked as required by Directive 2011/65/EU. Components may not be CE marked. Additionally, the part numbers that TE has identified as EU ELV compliant have a maximum concentration of 0.1% by weight in homogenous materials for lead, hexavalent chromium, and mercury, and 0.01% for cadmium, or qualify for an exemption to these limits as defined in the Annexes of Directive 2000/53/EC (ELV). Regarding the REACH Regulation, the information TE provides on SVHC in articles for this part number is based on the latest European Chemicals Agency (ECHA) 'Guidance on requirements for substances in articles' posted at this URL: <https://echa.europa.eu/guidance-documents/guidance-on-reach>

Compatible Parts

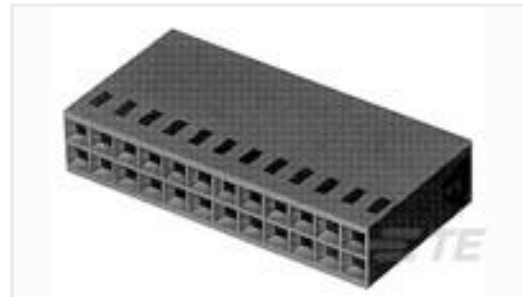

TE Part # 1-87456-1
16 MODIV HSG COMP DR .100CL

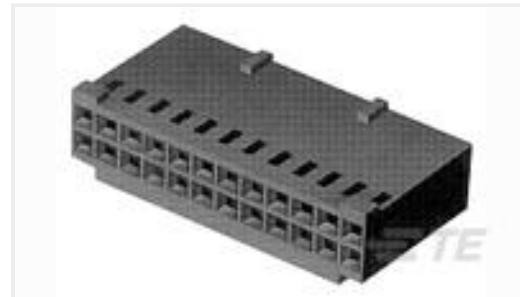

TE Part # 3-87977-3
16 MODIV HSG COMP DR .100 POL

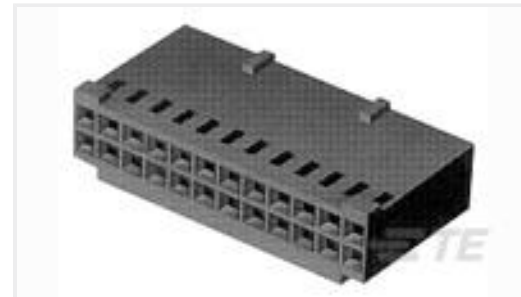

TE Part # 87977-6
16 MODIV HSG DR MRKD .100 POL

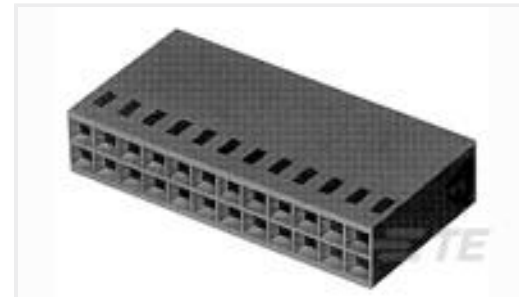

TE Part # 1-86177-5
16 MODIV HSG COMP DR .100CL

Also in the Series | AMPMODU Headers



Connector Contacts(52)



Connector Hardware(1)

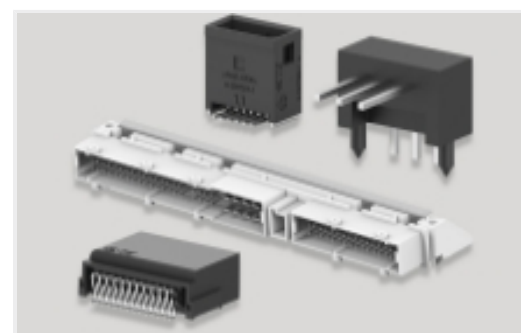

PCB Headers & Receptacles(1618)

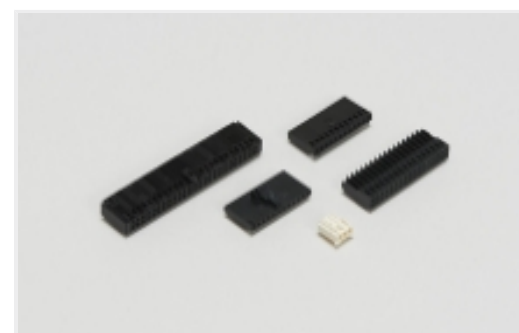

Wire-to-Board Connector Assemblies & Housings(5)

Customers Also Bought

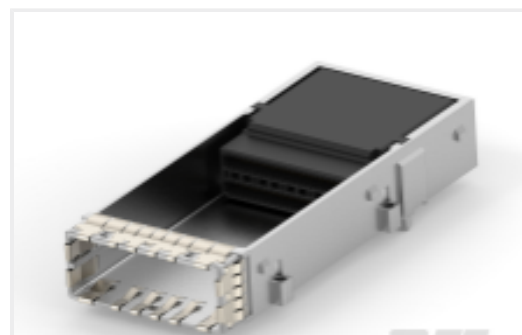

TE Part #2274233-1
CDFP RCPT SUB-ASSY STYLE 2

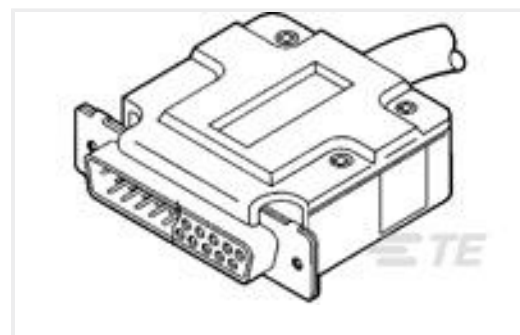

TE Part #207467-1
CABLE CLAMP KIT,SZ 1

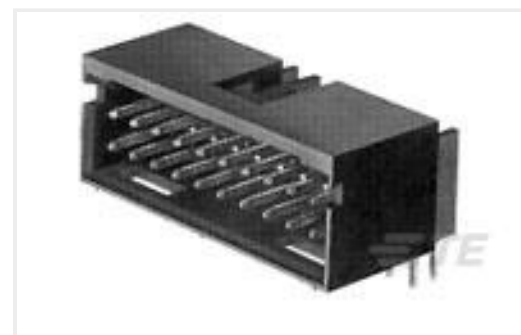

TE Part #103167-7
20 MODII HDR DRRA SHRD .100CL



TE Part #320563
PIDG Ring Tongue Terminals



TE Part #776261-4
14POS,PIN DIA 1.3,HDR ASSY,
180DEG,COD 4

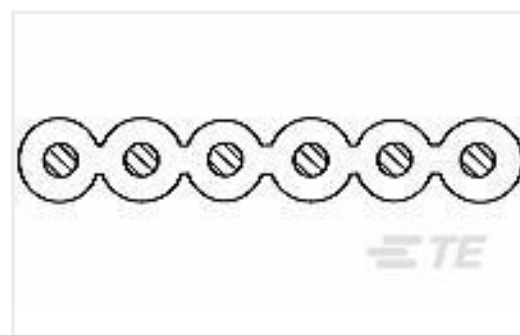

TE Part #1-57131-9
/RIB/44x30/-/PVC/UL2678/GY/-/



TE Part #368572-9
PDL 3P CAP 3.96 F/H(GWT) BLK

Documents

Product Drawings

16 MODII HDR DRRA SHRD .100CL

English

CAD Files



Customer View Model

[ENG_CVM_CVM_103167-5_R.2d_dxf.zip](#)

English

3D PDF

3D

Customer View Model

[ENG_CVM_CVM_103167-5_R.3d_igs.zip](#)

English

Customer View Model

[ENG_CVM_CVM_103167-5_R.3d_stp.zip](#)

English

By downloading the CAD file I accept and agree to the [Terms and Conditions](#) of use.

Product Specifications

Product Specification

English