

2-320573-3 ✓ ACTIVE



PIDG

TE Internal #: 2-320573-3

Closed Ring Tongue Terminal, 18 AWG, 3/8 Stud Size, 9.53 mm [.375 in] Stud Diameter, Closed Barrel, Straight, Tin, Partially Insulated, PIDG

[View on TE.com >](#)

Terminals & Splices > Ring Terminals > PIDG Ring Tongue Terminals



Ring Terminal Product Type: Closed Ring Tongue Terminal

Wire Size: 1900 CMA

Stud Size: 3/8

Stud Diameter: 9.53 mm [.375 in]

[All PIDG Ring Tongue Terminals \(410\)](#)

Features

Product Type Features

Ring Terminal Product Type	Closed Ring Tongue Terminal
Stud Size	3/8
Sealable	No
Wire Insulation Support Retention Type	Insulation Restriction

Dimensions

Wire Size	1900 CMA
Stud Diameter	9.53 mm [.375 in]
Tongue Thickness	.79 mm [.031 in]
Product Length	30.94 mm [1.218 in]
Compatible Insulation Diameter (Max)	2.79 mm [.11 in]
Compatible Insulation Diameter Range	1.42 – 2.79 mm [.056 – .11 in]

Contact Features

Barrel Type	Closed
-------------	--------



Terminal Orientation	Straight
----------------------	----------

Terminal Plating Material	Tin
---------------------------	-----

Military Part Class	Class I
---------------------	---------

Usage Conditions

Insulation Option	Partially Insulated
-------------------	---------------------

Operating Temperature Range	105 °C[221 °F]
-----------------------------	----------------

Operation/Application

Compatible With Wire Base Material	Copper
------------------------------------	--------

Compatible With Wire Plating Material	Tin
---------------------------------------	-----

Packaging Features

Packaging Method	Loose Piece
------------------	-------------

Packaging Quantity	1000
--------------------	------

Other

EU RoHS Compliance	Compliant
--------------------	-----------

EU ELV Compliance	Compliant
-------------------	-----------

Configuration Features

Number of Holes	1
-----------------	---

Electrical Characteristics

Voltage Rating	300 V
----------------	-------

Body Features

Product Weight	1.241 g
----------------	---------

Stripe Color	White
--------------	-------

Mechanical Attachment

Wire Insulation Support	With
-------------------------	------

Industry Standards

Government Qualified Terminal	Yes
-------------------------------	-----

Product Compliance

For compliance documentation, visit the product page on [TE.com](https://www.te.com)>

EU RoHS Directive 2011/65/EU	Compliant
------------------------------	-----------

EU ELV Directive 2000/53/EC	Compliant
-----------------------------	-----------











China RoHS 2 Directive MIIT Order No 32, 2016	No Restricted Materials Above Threshold
EU REACH Regulation (EC) No. 1907/2006	Current ECHA Candidate List: JUNE 2024 (241) Candidate List Declared Against: JUNE 2024 (241) Does not contain REACH SVHC
Halogen Content	Low Halogen - Br, Cl, F, I < 900 ppm per homogenous material. Also BFR/CFR/PVC Free
Solder Process Capability	Not applicable for solder process capability

Product Compliance Disclaimer

This information is provided based on reasonable inquiry of our suppliers and represents our current actual knowledge based on the information they provided. This information is subject to change. The part numbers that TE has identified as EU RoHS compliant have a maximum concentration of 0.1% by weight in homogenous materials for lead, hexavalent chromium, mercury, PBB, PBDE, DBP, BBP, DEHP, DIBP, and 0.01% for cadmium, or qualify for an exemption to these limits as defined in the Annexes of Directive 2011/65/EU (RoHS2). Finished electrical and electronic equipment products will be CE marked as required by Directive 2011/65/EU. Components may not be CE marked. Additionally, the part numbers that TE has identified as EU ELV compliant have a maximum concentration of 0.1% by weight in homogenous materials for lead, hexavalent chromium, and mercury, and 0.01% for cadmium, or qualify for an exemption to these limits as defined in the Annexes of Directive 2000/53/EC (ELV). Regarding the REACH Regulation, the information TE provides on SVHC in articles for this part number is based on the latest European Chemicals Agency (ECHA) 'Guidance on requirements for substances in articles' posted at this URL: <https://echa.europa.eu/guidance-documents/guidance-on-reach>

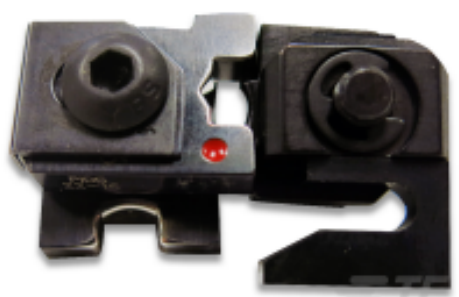
Compatible Parts

 <p>REPRESENTATION ONLY</p> <p>TE Part # 47386-4 DAHT PG PIDG 26-16 ASSY</p>	 <p>REPRESENTATION ONLY</p> <p>TE Part # 47386 DAHT PG PIDG 26-16 ASSY</p>	 <p>TE Part # 58433-3 PRO CR ASSY, RBY IS9252</p>	 <p>REPRESENTATION ONLY</p> <p>TE Part # 525690 DAHT PG PIDG 20-18 ASSY</p>
 <p>TE Part # 58423-1 DIE, RBY IS9252</p>	 <p>TE Part # 2063030-1 SDE DIESET, RBY, UL</p>	 <p>TE Part # 47806-2 DIES PIDG 22-16 DIE SET</p>	 <p>TE Part # 59300 T-HEAD PIDG PG 26-16 ASSY</p>

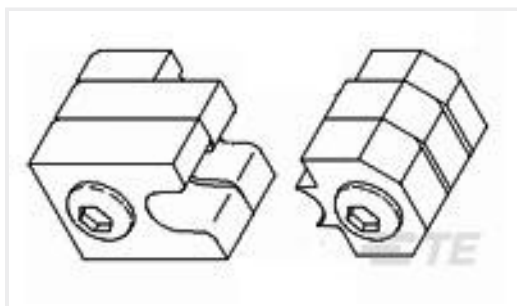

TE Part # 69344
PIDG 26-22 DIE SET

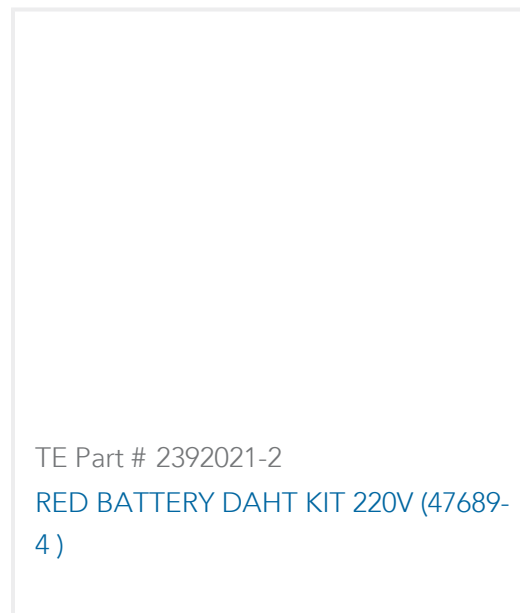

TE Part # 2392021-2
RED BATTERY DAHT KIT 220V (47689-4)

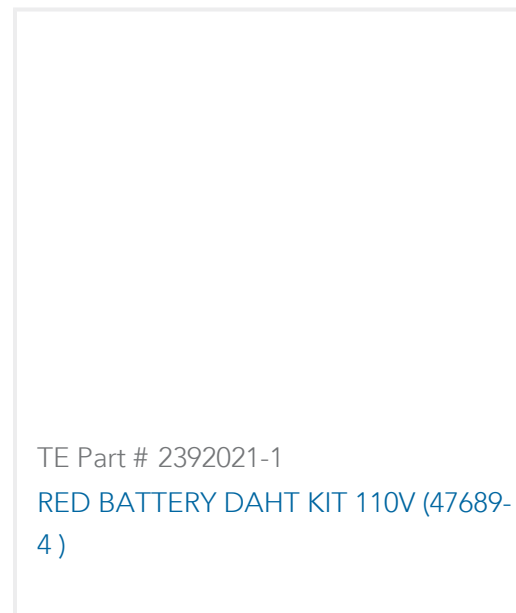

TE Part # 2392021-1
RED BATTERY DAHT KIT 110V (47689-4)



TE Part # 169404
CERTI-LOK DIE

Also in the Series | PIDG



Compression Connectors(17)



Crimp Wire Pins, Tabs & Ferrules(41)



Hand Crimping Tools(2)

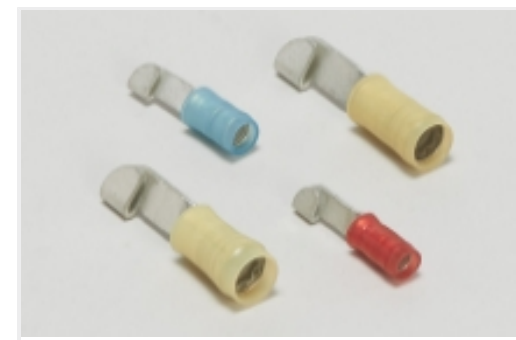

Knife Disconnects(11)

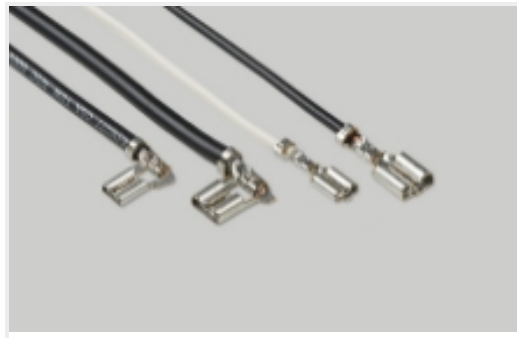

Quick Disconnects(32)



Ring Terminals(588)

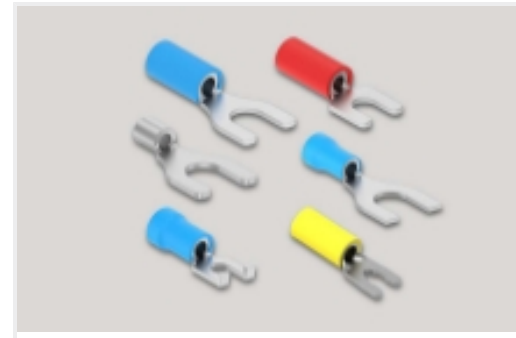

Spade Terminals(228)



Special Purpose Terminals(1)



Splices(39)

Customers Also Bought



TE Part #T4151310008-001
RPC-M12-FS-8CON-PVC-0.5



TE Part #342143-1
16-14 F.E.P.G. R/TONGUE



TE Part #1546306-2
2P .374" DR BARRIER STRIP



TE Part #CONMMCX007-R178
MMCX Plug 50 Ohm Cable Crimp

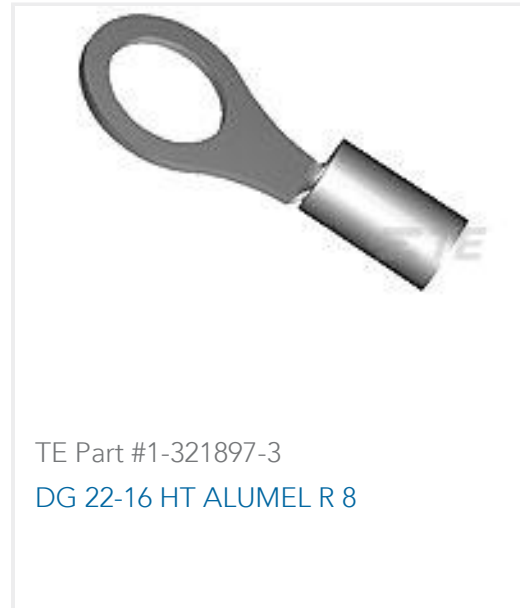

Documents

Product Drawings

[TERMINAL,PIDG R IR 18 3/8](#)

English

CAD Files

[3D PDF](#)

3D

Customer View Model

[ENG_CVM_CVM_2-320573-3_Z.2d_dxf.zip](#)

English

Customer View Model

[ENG_CVM_CVM_2-320573-3_Z.3d_igs.zip](#)

English

Customer View Model

[ENG_CVM_CVM_2-320573-3_Z.3d_stp.zip](#)

English

By downloading the CAD file I accept and agree to the [Terms and Conditions](#) of use.