

55768-1 ✓ ACTIVE

PIDG

TE Internal #: 55768-1

Spring Spade Terminal, 22 – 16 AWG, #8 / M4 Stud Size, 4.17 mm [.164 in] Stud Diameter, Closed Barrel, Straight, Tin, Partially Insulated, PIDG

[View on TE.com >](#)



Terminals & Splices > Spade Terminals > PIDG Short Spring Spade Tongue Terminals

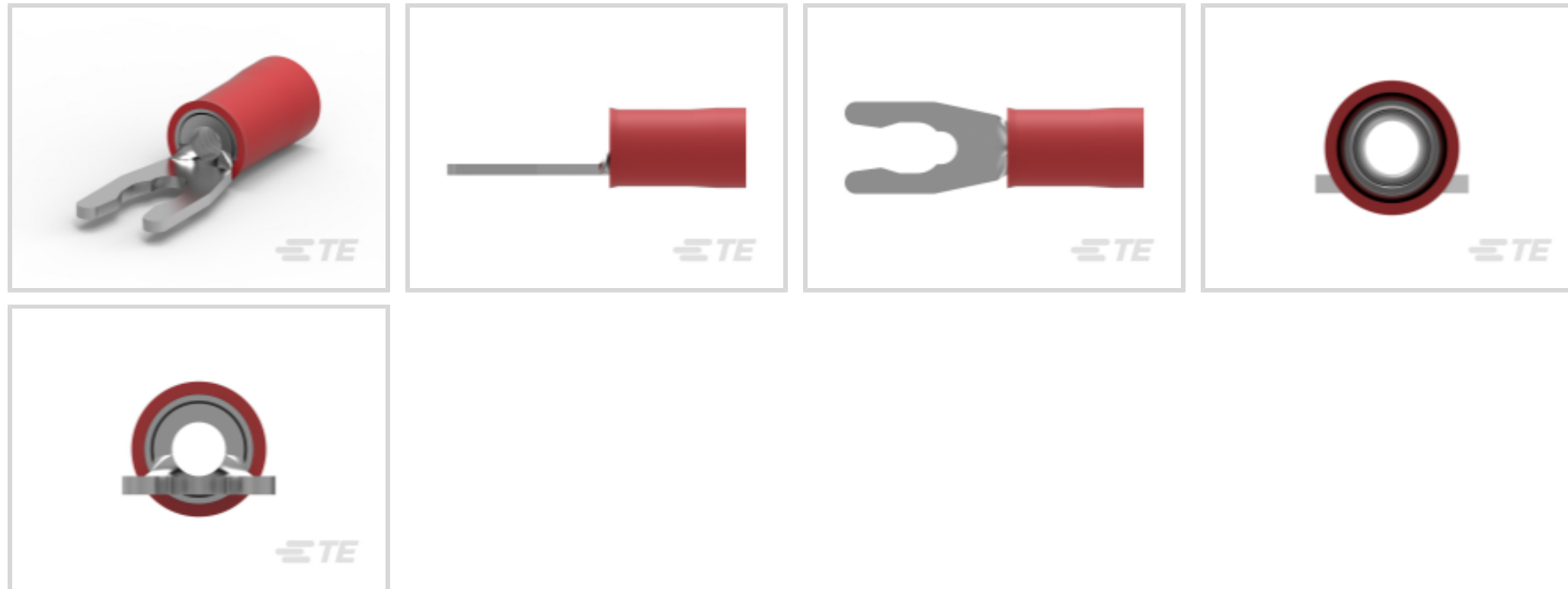

Spade Terminal Type: **Spring Spade Terminal**

Wire Size: **509 – 3260 CMA**

Stud Size: **#8, M4**

[All PIDG Short Spring Spade Tongue Terminals \(38\)](#)

### Features

#### Contact Features

Spade Terminal Type	Spring Spade Terminal
Barrel Type	Closed
Terminal Orientation	Straight
Terminal Plating Material	Tin

#### Dimensions

Wire Size	509 – 3260 CMA
Stud Diameter	4.17 mm[.164 in]
Tongue Thickness	.79 mm[.031 in]
Product Length	25.2 mm[.992 in]
Compatible Insulation Diameter (Max)	3.56 mm[.14 in]
Compatible Insulation Diameter Range	2.67 – 3.56 mm[.105 – .14 in]

#### Product Type Features

Stud Size	#8, M4
Sealable	No



Wire Insulation Support Retention Type	Insulation Support
--	--------------------

### Usage Conditions

Insulation Option	Partially Insulated
Operating Temperature Range	105 °C[221 °F]

### Operation/Application

Compatible With Wire Base Material	Copper
Compatible With Wire Plating Material	Tin

### Packaging Features

Packaging Method	Tape Mounted
Packaging Quantity	5000

### Other

EU RoHS Compliance	Compliant
EU ELV Compliance	Compliant

### Electrical Characteristics

Voltage Rating	300 V
----------------	-------

### Mechanical Attachment

Wire Insulation Support	With
-------------------------	------

### Industry Standards

Government Qualified Terminal	No
-------------------------------	----

## Product Compliance

[For compliance documentation, visit the product page on TE.com>](#)

EU RoHS Directive 2011/65/EU	Compliant
EU ELV Directive 2000/53/EC	Compliant
China RoHS 2 Directive MIIT Order No 32, 2016	No Restricted Materials Above Threshold
EU REACH Regulation (EC) No. 1907/2006	Current ECHA Candidate List: JUNE 2024 (241) Candidate List Declared Against: JUNE 2024 (241) Does not contain REACH SVHC
Halogen Content	Low Halogen - Br, Cl, F, I < 900 ppm per homogenous material. Also BFR/CFR/PVC Free
Solder Process Capability	Not applicable for solder process capability

#### Product Compliance Disclaimer

This information is provided based on reasonable inquiry of our suppliers and represents our current actual knowledge based on the information they provided. This information is subject to change. The part numbers that TE has identified as EU RoHS compliant have a maximum concentration of 0.1% by weight in homogenous materials for lead, hexavalent chromium, mercury, PBB, PBDE, DBP, BBP, DEHP, DIBP, and 0.01% for cadmium, or qualify for an exemption to these limits as defined in the Annexes of Directive 2011/65/EU (RoHS2). Finished electrical and electronic equipment products will be CE marked as required by Directive 2011/65/EU. Components may not be CE marked. Additionally, the part numbers that TE has identified as EU ELV compliant have a maximum concentration of 0.1% by weight in homogenous materials for lead, hexavalent chromium, and mercury, and 0.01% for cadmium, or qualify for an exemption to these limits as defined in the Annexes of Directive 2000/53/EC (ELV). Regarding the REACH Regulation, the information TE provides on SVHC in articles for this part number is based on the latest European Chemicals Agency (ECHA) 'Guidance on requirements for substances in articles' posted at this URL: <https://echa.europa.eu/guidance-documents/guidance-on-reach>

## Compatible Parts



## Also in the Series | PIDG

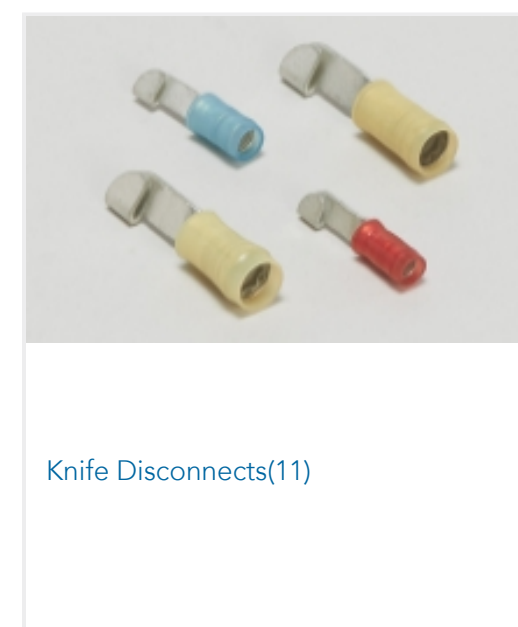
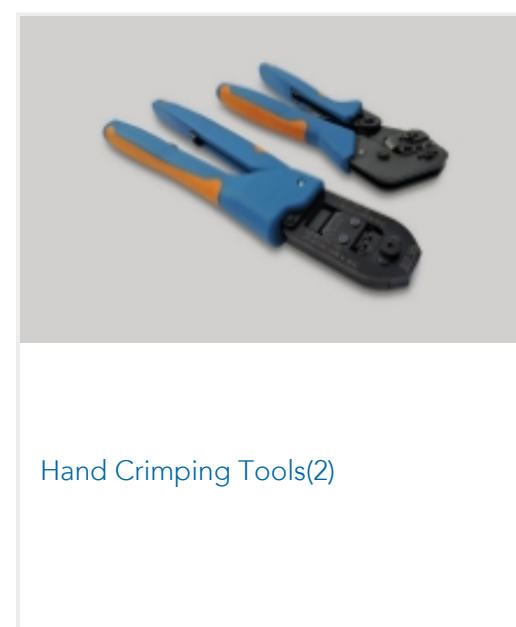
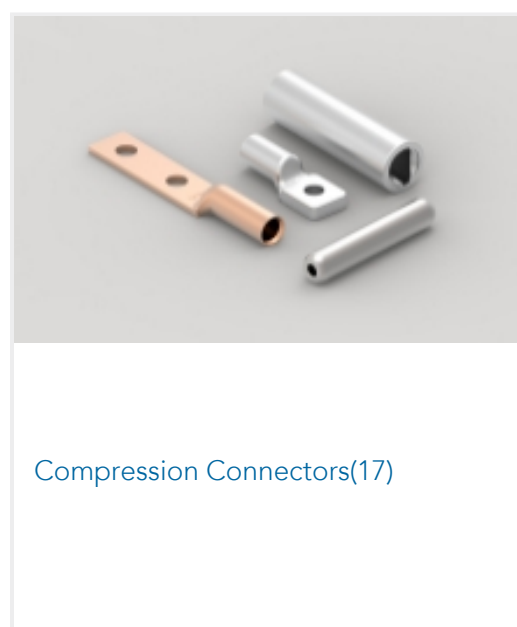



Quick Disconnects(32)

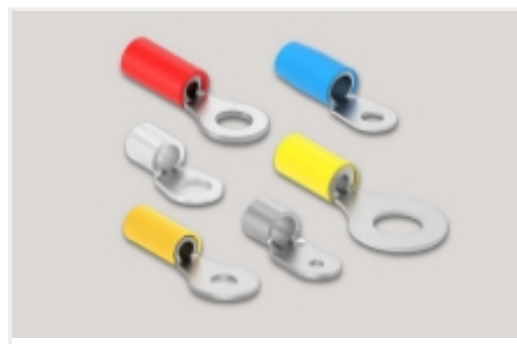

Ring Terminals(588)

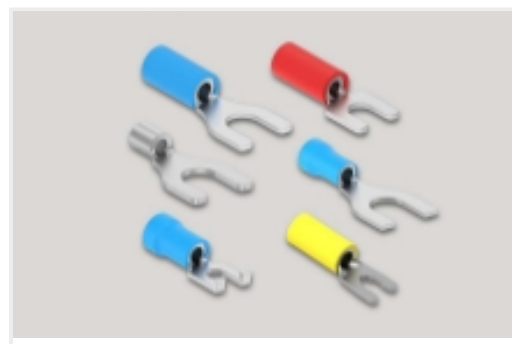

Spade Terminals(228)



Special Purpose Terminals(1)



Splices(39)

### Customers Also Bought

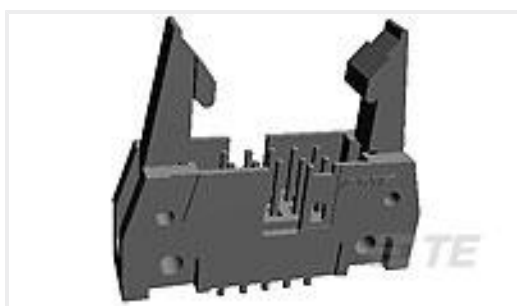

TE Part #5102321-3  
A/L UNIV HDR 16P VERT LG LAT

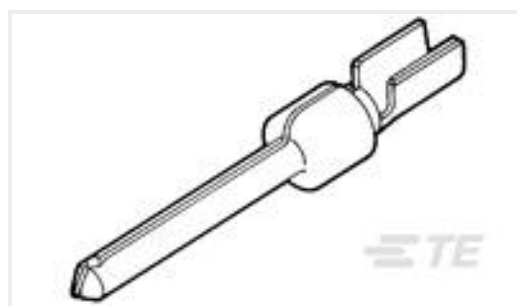

TE Part #745229-2  
20 DF PIN PLTD 30 SEL

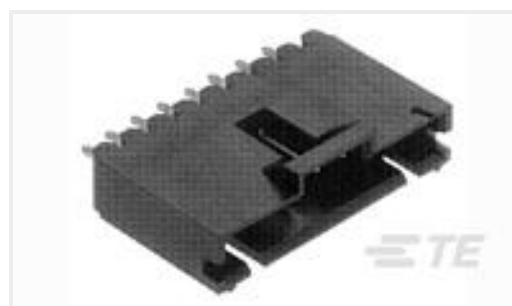

TE Part #5-103639-4  
05 MTE HDR SRST LATCH .100CL



TE Part #53244-2  
TERMINAL,PG SPR SPD 16-14 8



TE Part #66100-4  
III+ SKT,18-16,30AU/FL,STRIP



TE Part #2-34145-1  
PG R 22-16 COMM 22-18 MIL 8



TE Part #61117-1  
CMNL SOK 20-14 TPBR



TE Part #66400-2  
III+ PIN,24-20,30AU>10,LP



TE Part #2-324075-1  
TERMINAL,PIDG R 26-22 10



TE Part #62613-3  
RING .190 12-10 AWG 024 TPCU

### Documents



### Product Drawings

[TERM,PIDG SPR SPD 22-16 8](#)

English

---

### CAD Files

[3D PDF](#)

English

Customer View Model

[ENG\\_CVM\\_55768-1\\_B.3d\\_igs.zip](#)

English

Customer View Model

[ENG\\_CVM\\_55768-1\\_B.3d\\_stp.zip](#)

English

Customer View Model

[ENG\\_CVM\\_55768-1\\_B.2d\\_dxf.zip](#)

English

By downloading the CAD file I accept and agree to the [Terms and Conditions](#) of use.

---

### Instruction Sheets

[Instruction Sheet \(U.S.\)](#)

English